

Aliaxis Industrial Piping Systems Engineering Manual



Contents

We make life flow	8
Introduction	10
1. Plastic piping systems: physical and chemical properties of materials	19
1.1 Development, differentiation and manufacturing of plastics	20
1.1.1 Development of plastics	20
1.1.2 Structure and characteristics	21
1.1.3 Thermosets, thermoplastic and elastomers	22
1.1.4 An overview of thermoplastics properties	27
1.1.5 Advantages of using plastics over metals	30
1.1.6 Plastics and environment	32
1.1.7 Manufacturing and processing methods	34
1.1.7.1 Polymerization	34
1.1.7.2 Injection and extrusion	35
1.2 Vinyl and Styrenic polymers	39
1.2.1 Unplasticized Polyvinyl Chloride (UPVC)	39
1.2.2 Chlorinated Polyvinyl Chloride (CPVC)	42
1.2.3 Acrylonitrile Butadiene Styrene (ABS)	44
1.3 Polyolefins and Fluorinated polymers	47
1.3.1 Polypropylene (PP)	47
1.3.2 Polyethylene (PE)	53
1.3.3 Polyvinylidene fluoride (PVDF)	57
1.4 Rubber	60
1.4.1 Acrylonitrile Butadiene (NBR)	61
1.4.2 Ethylene Propylene Diene Monomer (EPDM)	62
1.4.3 Fluoroelastomer (FKM)	63
1.4.4 Perfluoroelastomer (FFKM)	64
1.5 Polytetrafluoroethylene (PTFE)	66
1.6 Resins, compounds and additives	67
1.6.1 Resins	67
1.6.2 Compounds	67
1.6.3 Additives	67
1.7 Material test	68
1.7.1 Impact test	68
1.7.2 Melt flow test	70
1.7.3 Thermal test	71
1.8 Pipe and fittings marking	72
1.8.1 Minimum requirements in marking of pipes	72
1.8.2 Minimum requirements in marking of fittings	73
1.8.3 Minimum requirements in marking of valves	73

1.9 MRS and Long-Term Behaviour	74
1.9.1 Terms associated with long-term behaviour	74
1.9.2 Long-term behaviour of UPVC	75
1.9.3 Long-term behaviour of CPVC	77
1.9.4 Long-term behaviour of ABS	79
1.9.5 Long-term behaviour of PP-H, PP-B, and PP-R	80
1.9.6 Long-term behaviour of PE	83
1.9.7 Long-term behaviour of PVDF	85
1.9.8 Service life in case of intermitted load	86
1.10 Creep modulus	87

2.Design of plastic piping systems	105
2.1 Symbols, abbreviations, units, conversion tables	106
2.1.1 Symbols	106
2.1.2 Abbreviations	107
2.1.3 Units	109
2.2 Material selection	113
2.3 Chemical resistance	114
2.4 Dimensioning and hydraulic engineering	117
2.4.1 Pipe design	117
2.4.1.1 Calculation of design stress based on MRS classification	117
2.4.1.2 Calculation of nominal pressure	118
2.4.1.3 Calculation of standard dimension ratio	119
2.4.1.4 Calculation of series	119
2.4.1.5 Calculation of wall thickness	119
2.4.2 Pressure-temperature diagram	125
2.4.2.1 Permissible pressure - temperature diagram	126
2.4.2.2 Nominal pressure - temperature diagram	132
2.4.3 Hydraulic calculation	137
2.4.3.1 Distributed head loss calculation	139
2.4.3.2 Localized head loss calculation	142
2.4.4 Valve flow regulation and sizing	147
2.4.5 Pressure surge	151
2.4.5.1 Water hammer	151
2.4.5.2 Cavitation	154
2.5 Valve selection and features	156
2.5.1 Fluid characteristics	156
2.5.2 Mechanical stress and vibrations	157
2.5.3 Safety	159
2.5.4 Security	160
2.5.5 Easy installation	161
2.5.6 Accurate regulation	162
2.6 Air release from pipelines	163
2.6.1 Entrapped air: sources and causes	163
2.6.2 Dealing with entrapped air	164
2.7 Piping system design for vacuum condition	165

2.8 Piping system design for compressed air	166
2.9 Selection of flowmeter	169
2.9.1 Flowmeter design	169
2.9.1.1 Insertion flow sensors	169
2.9.1.2 In line flow sensors	171
2.9.1.3 Variable area flowmeters	172
2.9.2 Flowmeter installation	174
2.9.2.1 Insertion flow sensors	174
2.9.2.2 In line flow sensors	176
2.9.2.3 Variable area flowmeters	176
2.10 Selection of pH and ORP sensor	178
2.10.1 pH and ORP sensor design	178
2.10.1.1 pH measurement	178
2.10.1.2 ORP measurement	181
2.10.1.3 pH/ORP electrodes	182
2.10.2 pH and ORP sensor installation	184
2.10.2.1 Installation guidelines	184
2.10.2.2 Operating guidelines	185
2.11 Selection of conductivity sensor	186
2.11.1 Conductivity sensor design	186
2.11.1.1 Conductivity measurement	186
2.11.1.2 Conductivity electrodes	188
2.11.2 Conductivity sensor installation	189
2.11.2.1 Installation guidelines	189
2.11.2.2 Operating guidelines	190
3. Installation guidelines	193
3.1 Jointing methods	194
3.1.1 Solvent welding	195
3.1.1.1 Solvent welding of piping system in UPVC	196
3.1.1.2 Solvent welding of piping system in CPVC	200
3.1.1.3 Solvent welding of piping system in ABS	204
3.1.2 Butt welding	210
3.1.3 Socket welding	217
3.1.4 Electrofusion	224
3.1.5 Hot gas welding	228
3.1.6 Flanged joints	232
3.1.7 Threaded joints	239
3.1.8 Straub mechanical joints	243
3.2 Pipeline mounting and recommendations	253
3.2.1 Thermal expansion and contraction	253
3.2.1.1 Mechanical expansion joints	254
3.2.1.2 Offset	259
3.2.1.3 Expansion loops and direction changes	259
3.2.2 Heat tracing	261
3.2.3 Pipelines anchoring	264
3.2.3.1 Piping support and pipe restraint	265
3.2.3.2 Tables and graphs	267
3.2.4 Underground installation (buried system)	279

3.3 Pipeline testing on-site	284
3.4 Storage, transportation and handling	288
4. System and product solutions	291
4.1 Solvent welded UPVC systems	294
4.2 Solvent welded FIP CPVC systems	296
4.3 Solvent welded SuperFlo ABS systems	298
4.4 Welded FIP PP systems	300
4.5 Welded PE systems	302
4.6 Welded FIP PVDF systems	304
4.7 Double containment	306
4.8 Compressed air	308
4.9 Fuel system PLX	310
4.10 Vulcathene	311
4.11 Straub mechanical joints	312
4.12 FIP Silicone free system	314
4.13 FLS	316



We make life flow

Aliaxis is a global leader in advanced plastic piping systems for industrial, building, infrastructure and agriculture applications. For each of these segments, we offer a comprehensive range of high-quality product and solutions that meet our customers' most demanding needs across the globe.

Aliaxis, with a global workforce of about 15,500 employees, is active through leading local brands and operates in over 45 countries, combining local solutions with global innovation and operational excellence. The company is privately owned, with its global headquarters in Brussels, Belgium.

Health and safety above all

Providing a safe and secure working environment for all employees, contractors and visitors is our top priority. We aim to increase our overall safety performance, with a goal of zero accidents worldwide. The global safety community, consisting of Health and Safety managers from our different divisions, is dedicated to the transfer of best practices.

Our customers at heart

Aliaxis supplies installers and technicians worldwide with products and solutions to get projects up and running in an easy and reliable way.

We aim to add value for the end-users: people in their homes, farmers, industries and governments. Whatever the challenges in terms of size, volume or height, whatever the constraints on building sites, in infrastructure projects or with irrigation requirements on agricultural land, we always strive to offer the appropriate products and solutions.

Care for local communities

The Aliaxis businesses were founded in the heart of the regions in which they operate. They care greatly about those local communities and reinvest in their future through various projects. In many of the communities, Aliaxis helps to install or improve drinking water supplies, to provide sanitation facilities, to implement infrastructure projects for collecting and storing rainwater, to drill groundwater wells, but also to build schools or implement local education programmes.



Innovate to create value

With over 50 years of expertise in plastics, we are able to develop products which are always an idea ahead.

In all our manufacturing sites and facilities across the world, Aliaxis teams strive for operational excellence and efficiency in developing products and services.

The Group facilitates the exchange of best practices and knowledge across all countries and segments.

This continuously optimises and streamlines internal processes, improving service delivery for our customers.

Our commitment to the environment

Lifecycle analyses have shown that plastic pipe systems are not only more environmentally-friendly but also healthier alternatives to pipes made from other materials.

Environmental protection is taken into account for each of our business processes. Our environmental programme defines specific KPIs for monitoring CO₂ emissions, non-recycled waste and water consumption. It also includes initiatives aimed at sharing best practices and training, as well as raising environmental awareness among our employees.

Introduction

When deciding what could be the best material to be suited to your needs as well as being a great option for the environment, think about plastic.

During last years, industrial and commercial markets have been slow to include the use of thermoplastic material due to two main reasons: first the plastics industry probably has not done a good job of training the public and the market place to the advantages and capabilities of plastic products, second industries have been unwilling to adapt to more developing and efficient piping materials or to change their habits.

Therefore, even if the thermoplastic industrial piping system is more cost-effective in almost every industrial application compared to alternative systems, nowadays in piping market, where plastic pipe, fittings and valves could be capable of handling around 70% of all industrial applications, actually less than 15% is used.

While a lack of economic pressure in past years has kept several industries from moving towards plastic materials, actually today's competitive global environment will bring about some change easier.

What is in store for the next hundred years in plastic is difficult to predict, but it will for sure be life-changing: the graph on the next page shows how the worldwide production of plastic has increased from 1950 to 2019.

The advantages and benefits of plastic solutions are significant and will finally turn farthest industries in favour of its use. Why plastic pipes are used in several applications can be summarized in four main reasons:

- Durability.
- Environmental soundness.
- Ease and safety installation.
- Cost-effectiveness.

Since another much discussed topic often associated with the word plastic is sustainability, by analysing these four previous features, it is possible to notice that plastic piping can reduce greenhouse gas emissions in the environment; let's explain why.

The term durability indicates a long working life. Over dozens of years of use, just a very little change occurs to the physical or molecular characteristics of plastic piping: theoretically, in most installations, there is no known end-life of the piping system.

In addition, many researches have shown that the service life of a plastic pipe is not comparable to pipe systems made of other materials, because of its resistance to chemical and corrosive attack, its abrasion resistance, joint integrity and optimum flow characteristics.

These last features are also directly linked with the topic of environmental soundness: the high degree of chemical and corrosion resistance eliminates the need for protective coatings that other piping materials might require.

Moreover, since plastics have few friction loss in the smooth inner pipe walls, this minimizes the pumping horsepower required to move the fluid.

All these peculiarities affect positively the energy savings: if less energy is used the emissions are lower as a result.

Since with plastic materials there are fewer breakages and a reduced need for maintenance, consequently a lower need for gas and electric-powered repair equipment is obtained. Obviously, fewer orders and shipping occur, therefore the costs related to transport can be significantly reduced.



As for installation, plastics are easier and safer to install than any other piping material. They offer a variety of joining methods and product line, multiple exterior walled colour identification and code acceptance.

In particular, plastic pipes are well known for their lightweight: this greatly decreases the need for expensive lifting equipment and therefore there will be again fewer emissions into the environment. Another advantage of the lightweight of plastic is the lower chance of injury in the field: in most cases, the tools and techniques for joining plastic pipes are inexpensive, easy to use and speeding up installation time.

About cost-effectiveness could be enough to say that in most cases, plastics cost less than other piping materials, but the out-and-out cost saving is linked to all the features mentioned above, such as that plastic pipes are easy to install, maintain and transport.

To conclude, when evaluating piping materials it is better not to look just at one facet of the product: it is recommended to consider the complete list of features and benefits that can be obtain in the long term.

This observation will make it easy to deduce that nowadays plastic is becoming one of the predominant choices for most piping projects.

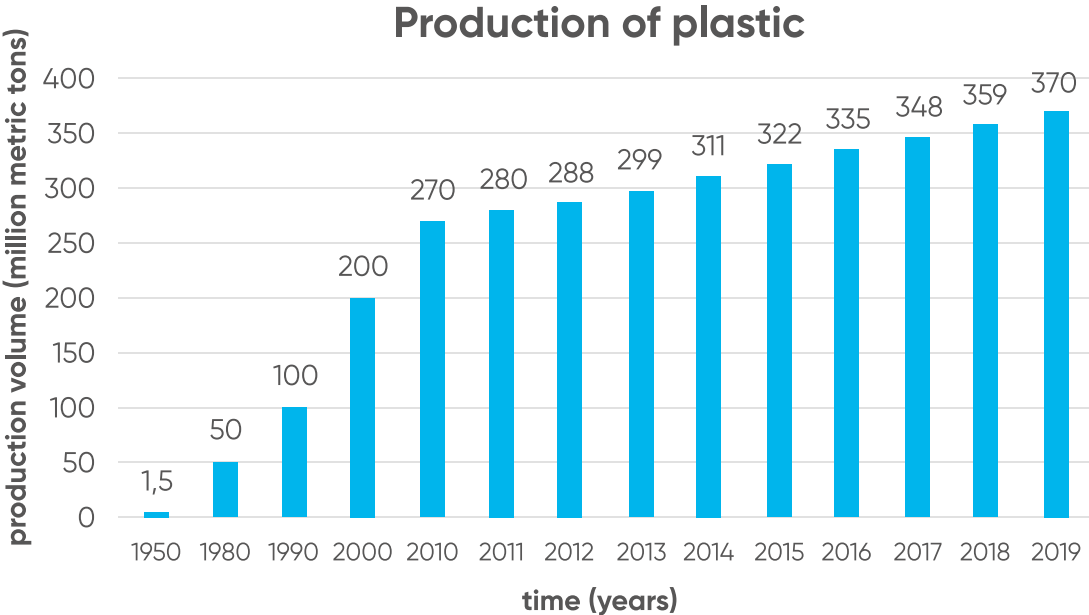

Market segments

The following examples could be useful to demonstrate the various use of plastic piping in many industries and markets. The main fields in which Aliaxis products are used are the following ones.



Water treatment

Many areas of the world are already experiencing stress on water availability mainly due to the accelerated growth of population.

Aliaxis is a reliable supplier for the most important municipal and industrial water and wastewater treatment processes where is required to remove the contaminants from the different water sources and to convert wastewater into an effluent that can be reused or returned to the water cycle with minimal environmental impact. Let's examine these sectors in detail:

- Municipal wastewater treatment: it is a key sector to keep a clean water cycle: pollution from municipal waste is one of the main challenging issue of the future as the population growth in various geographical areas strongly require new and more efficient wastewater treatment plant. It contains biological human waste and organic garbage, detergents, oils, paper fibers as well as other highly polluting chemicals that have to be neutralized to minimize the environmental footprint.
- Industrial water treatment: in the last decade it has emerged as one of the most important topic in industries such as oil and gas, refining and petrochemicals, pulp and paper, microelectronics, food and beverage, power generation and mining. Within these industries, reverse osmosis and ultrafiltration are the most important technologies associated with simple salt removal, while ion exchange and electrode ionization are mainly utilized when higher levels of water purity are requested, for example in microelectronic and pharmaceutical field.
- Industrial wastewater treatment: all industrial processes generate wastewater that have to be reconditioned before being reused or returned to the water cycle.

To take care of the environment and protect people and natural resources, environmental sustainability issues must be approached with sense of responsibility, in fact severe regulations are necessary to set new limits on discharge of wastewater and industrial facilities have to undertake effective actions to comply with these new conditions and requirements.
- Potable water treatment: potable water is the result of previous treatments, in fact the raw water can come from different sources: surface waters come from rivers, lakes and reservoirs, which may have a wide range of chemistries with high mineral and metal contents, chloride levels and particulates, while sea and brackish waters can also have different specific kinds of minerals and salts to be removed.
- Swimming pool and SPA: Aliaxis products, also chosen for the construction of Olympic facilities, offers numerous options to ensure uniform water circulation and support the swimming pool and SPA disinfection system, necessary to ensure safe and comfortable pools. Corrosion free materials, valves and filter system combine innovation and technology in order to get a safe and efficient conveyance of water.



Chemical process industry

The chemical industry creates a large variety of products, ranging from basic chemicals to specialty ones like adhesive or pulp additives.

Aliaxis range of market-leading plastic pipework products are a perfect solution for a range of different applications. Whether it be aggressive acids conveyance, specialist drainage or auxiliary services requirements, our pipework system can easily overcome some of the problems associated with more traditional pipework materials, in fact full plastic piping solutions offer a superior chemical resistance, an easier installation, a longer plant life, reducing first installation and maintenance costs.

Among the most common industrial processes, where plastic piping solutions are used, there are:

- Chloro alkali plants: electrolysis membrane technology is the dominant technology. Plastic piping systems are used in Anolyte, Catholyte, gaseous Chlorine as well as auxiliary services.
- Fertilizers plants: within the different fertilizers processing plants, plastic piping is used in diammonium phosphate and sulphur based ones.
- Bromine plants: thermoplastic piping is used after the main reactor to convey the chemicals and related by-products.
- Fine chemicals production and batching.
- Battery manufacturing production plants: there are different applications, from the typical one in automotive industry to the ones related to Consumer Electronics. Chemicals are used in the different steps of the production process.





Surface treatment

Surface treatment is among the main intermediary steps in the manufacturing of finished metal products, in fact it does not form a specific sector itself, as it provides a service to a wide range of other industries like computers and mobile phones components, automotive, aircraft and many others.

Metals and plastics are treated to change their surface properties for decoration and reflectivity, along with improved strength and wear resistance, corrosion prevention and as a base to improve adhesion of other treatments such as painting or photosensitive coatings for printing.

Plastic piping system retain their own properties such as chemical resistance, insulation and flexibility and are ideal to convey chemicals which are used to treat the surface as per the process requirements.

There are various processes that take place within this sector, the main ones are:

- Electrodeposition: it has the aim to deposit a thin but regular layer of a selected material on the processed item. It can be both on metal and plastic

surface. The film is deposited electrochemically using an electric field to transfer particle to a conductive surface.

- Galvanization: it has the aim to protect the processed surface against corrosion. A film is deposited on goods made of steel or plastic to provide long term corrosion protection and abrasion resistance. The most common galvanizing process is through a hot metal bath in which the item is immersed in molten metal to chemically deposit a film.
- Pickling lines: the process aims to remove impurities from the surface, such as stains or oxides like rust. It is typically applied in steel production.
- Painting lines: there are a range of different technologies used in surface painting, an important one is the electrophoretic coating where a metal part is immersed in a water based solution containing a paint emulsion.





Mining and hydrometallurgy

The aggressive environments of mining sites represent a challenge for piping systems which have been used in this application for decades to convey fluids.

In these applications, corrosion resistance and a cost effective solution for the conveyance of a high quantity of aggressive and slurry fluid is required.

Aliaxis offers a complete range solutions for the following applications:

- Mining extraction: both in open cut and underground mines, there is a huge need for process water and plastic piping is the ideal compromise between performance and easy installation.
- Ore beneficiation: this process includes different steps such as comminution circuits with primary, secondary and tertiary crushing, grinding and concentration. Plastic pipes can be used in each of these steps.
- Hydrometallurgy: there are different steps involved, for example head leaching, adsorption, elution, electrowinning, solvent extraction. In adsorption the double containment piping is suggested.
- Tailing disposal: these are the waste materials left over after the process of separating the valuable fraction from the uneconomic one. Plastic piping represents a long-standing solution, since they need to be properly conveyed and disposed of.





Marine applications

In recent years, the need to move people and goods ever more quickly and smoothly has led to a consistent development of the maritime sector.

Plastic solutions for conveying fluids, compared to traditional metal solutions, are the ideal option for shipbuilding, because plastic materials are corrosion resistant and much lighter, as well as being quick and easy to install.

Moreover, strict environmental regulations impose responsibilities for the control of exhaust gases and ballast discharges which require efficient and reliable solutions.

Aliaxis offers robust and high quality plastic systems: they are specially designed to reduce weight and noise on board civil and military vessels, by adding features such as fire prevention and reducing the risk of legionella bacteria spreading.

Our products improve the comfort and safety of passengers and crew, ensure uniform and constant performance throughout the time of use and a local technical assistance service is always available for any kind of advice.

The main marine applications to which our products can be applied are the following:

- Cruise ships.
- Ferries.
- Mega Yacht.
- Merchant fleets.
- Military ships.
- Offshore platforms.
- Fishing boats.







1 Plastic piping systems: physical and chemical properties of materials	20
1.1 Development, differentiation and manufacturing of plastics	20
1.1.1 Development of plastics	20
1.1.2 Structure and characteristics	21
1.1.3 Thermosets, thermoplastic and elastomers	22
1.1.4 An overview of thermoplastics properties	27
1.1.5 Advantages of using plastics over metals	30
1.1.6 Plastics and environment	32
1.1.7 Manufacturing and processing methods	34
1.1.7.1 Polymerization	34
1.1.7.2 Injection and extrusion	35
1.2 Vinyl and Styrenic polymers	39
1.2.1 Unplasticized Polyvinyl Chloride (UPVC)	39
1.2.2 Chlorinated Polyvinyl Chloride (CPVC)	42
1.2.3 Acrylonitrile Butadiene Styrene (ABS)	44
1.3 Polyolefins and Fluorinated polymers	47
1.3.1 Polypropylene (PP)	47
1.3.2 Polyethylene (PE)	53
1.3.3 Polyvinylidene fluoride (PVDF)	57
1.4 Rubber	60
1.4.1 Acrylonitrile Butadiene (NBR)	61
1.4.2 Ethylene Propylene Diene Monomer (EPDM)	62
1.4.3 Fluoroelastomer (FKM)	63
1.4.4 Perfluoroelastomer (FFKM)	64
1.5 Polytetrafluoroethylene (PTFE)	66
1.6 Resins, compounds and additives	67
1.6.1 Resins	67
1.6.2 Compounds	67
1.6.3 Additives	67
1.7 Material test	68
1.7.1 Impact test	68
1.7.2 Melt flow test	70
1.7.3 Thermal test	71
1.8 Pipe and fittings marking	72
1.8.1 Minimum requirements in marking of pipes	72
1.8.2 Minimum requirements in marking of fittings	73
1.8.3 Minimum requirements in marking of valves	73
1.9 MRS and Long-Term Behaviour	74
1.9.1 Terms associated with long-term behaviour	74
1.9.2 Long-term behaviour of UPVC	75
1.9.3 Long-term behaviour of CPVC	77
1.9.4 Long-term behaviour of ABS	79
1.9.5 Long-term behaviour of PP-H, PP-B, and PP-R	80
1.9.6 Long-term behaviour of PE	83
1.9.7 Long-term behaviour of PVDF	85
1.9.8 Service life in case of intermitted load	76
1.10 Creep modulus	87

1. Plastic piping systems: physical and chemical properties of materials

1.1 Development, differentiation and manufacturing of plastics

1.1.1 Development of plastics

The development of plastics has evolved from the use of natural plastic materials (chewing gum, shellac) to the use of chemically modified, natural materials (natural rubber, nitrocellulose, collagen, galalite) and finally to completely synthetic molecules (Bakelite, epoxy, polyvinyl chloride). Early plastics were bio-derived materials such as egg and blood proteins, which are organic polymers. In around 1600 BC, Mesoamericans used natural rubber for balls, bands, and figurines.

In the nineteenth century, as industrial chemistry developed during the Industrial Revolution, many materials were reported. The development of plastics also accelerated with Charles Goodyear's discovery of vulcanization to thermoset materials derived from natural rubber.

Parkesine (nitrocellulose) is considered the first man-made plastic. The plastic material was patented by Alexander Parkes, in Birmingham, England in 1856. Parkesine was made from cellulose, the major component of plant cell walls, treated with nitric acid as a solvent.

The output of the process, commonly known as cellulose nitrate or pyroxylin, could be dissolved in alcohol and hardened into a transparent and elastic material that could be moulded when heated.

In the early 1900s, Bakelite, the first fully synthetic thermoset, was reported by Belgian chemist Leo Baekeland by using phenol and formaldehyde.

The material developments over the years and the number of application possibilities of different plastic materials are the clear evidence that plastics play an inevitable role in our day to day life.

1.1.2 Structure and characteristics

Macromolecule chains, formulated from monomer units by chemical reactions, give polymers, the fundamental structure of plastics. Polyaddition (continuous or phase wise) and condensation polymerisation, called polycondensation, are common reactions for chain assembly.

These chains consist mainly of carbon and hydrogen. Organic carbon-based molecules are the units of monomers. In addition to carbon and hydrogen atoms, elements such as oxygen, nitrogen, sulphur, fluorine or chlorine may be found in the monomer unit as principal components.

The type of elements, their proportion and their location in the monomer molecule provide the basis for the manufacture of various plastics.

Different groups are described by the macromolecular composition and temperature-dependent physical properties of plastic materials.

Thermoplastics are of strong or tough elasticity in the application spectrum and can be melted by energy feedback (mechanical, thermal or radiation energy).

Elastomers have a gentle elasticity and can not necessarily be melted.

In the application spectrum, thermosets are of hard elasticity that cannot be melted either.

The picture below shows a detailed classification of plastics.

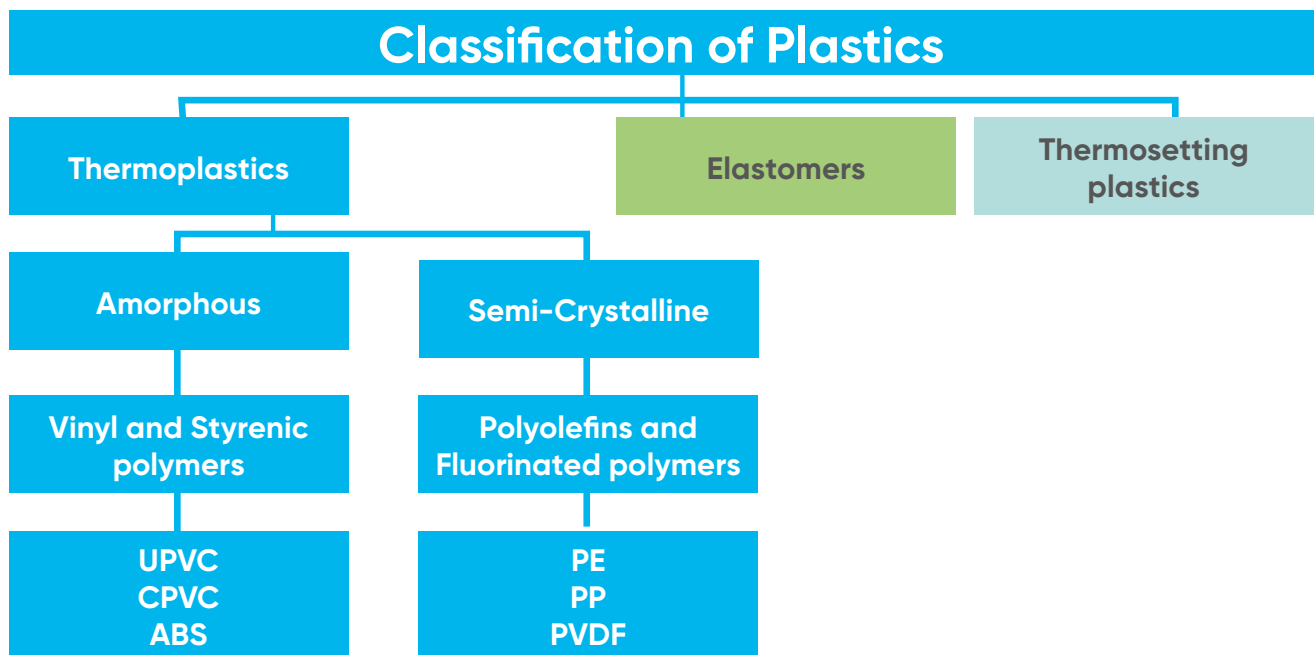

Monomer vs. Polymer

Plastic is a polymer, which means it is nothing more than a long chain of smaller units hooked together.

A good example of a polymer is polyethylene.

Ethylene (ethane) is the monomer and, when lots of these are connected end-to-end in a chain by a chemical reaction that breaks the double bond, a polymer is formed.

Monomers are obtained by refining petroleum. They are usually found naturally in oil or can be easily manufactured through simple chemical processes. It is important that the monomers are pure because contamination prevents them from polymerizing to form a chain and can also lead to weak or brittle plastic in the end.

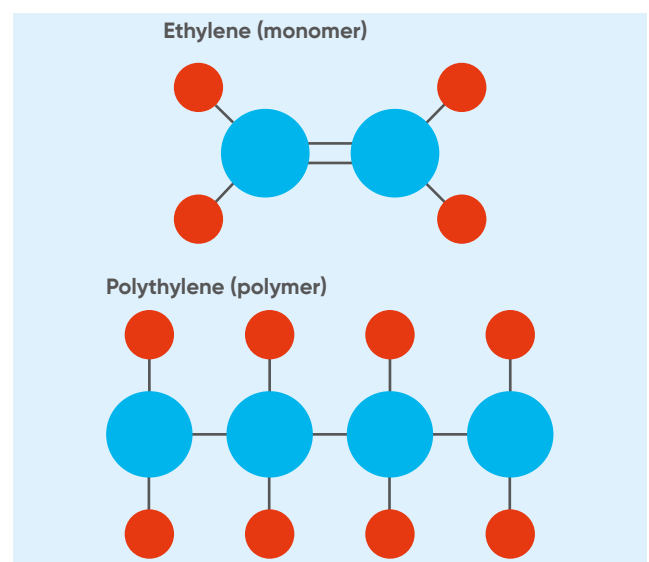

1.1.3 Thermosets, thermoplastics and elastomers

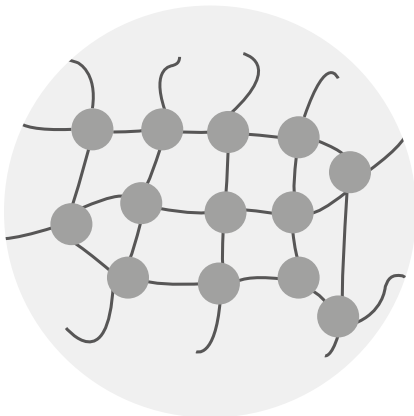

Thermosets

A plastic that, when cured by the application of heat or by chemical means, changes into a substantially infusible and non-recyclable product. Thermosets are plastic resins with narrow crosslinked molecular chains.

Egg analogy is used as an example to illustrate the behaviour of thermosets, which means that it can be processed only once with changes occurring in the material's basic properties.

Liquids



Mix/Heat



Solid

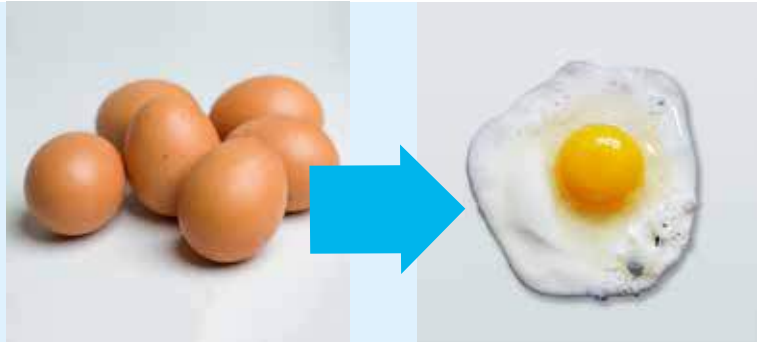

Mechanical properties of thermosets

Thermosets are hard and brittle. As with thermoplastics or elastomers, owing to the high resistance to molecular displacement induced by crosslinking, mechanical strength and elasticity are not temperature dependent. Thermosets cannot be melted and joined by thermal processes like welding.

The substance would be chemically decomposed upon reaching the decomposition temperature of (T_d).

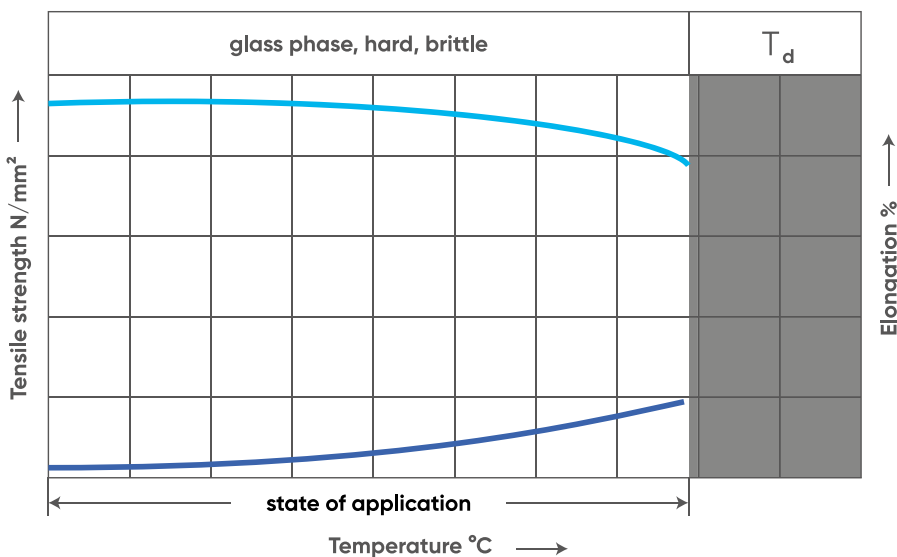

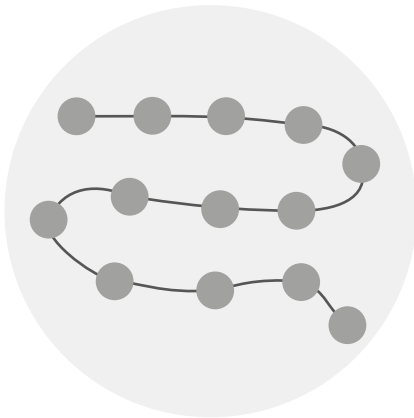

Thermoplastics

A plastic that can be repeatedly softened by heating and hardened by cooling through a temperature range characteristic of the plastic, and that in the softened state, can be shaped by flow into an article by moulding or extrusion. These are those plastic resins which are made up of linear molecular chains.

Water analogy is used as an example to show the thermoplastic material behaviour. The polymer can be heated and cooled repeatedly without any change in the material’s basic properties.

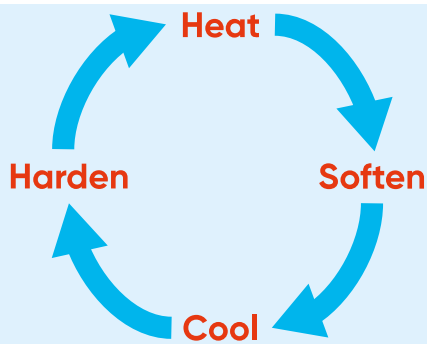

The thermoplastics are subdivided into two groups:

- Amorphous thermoplastics;
- Semi-cristalline thermoplastics.

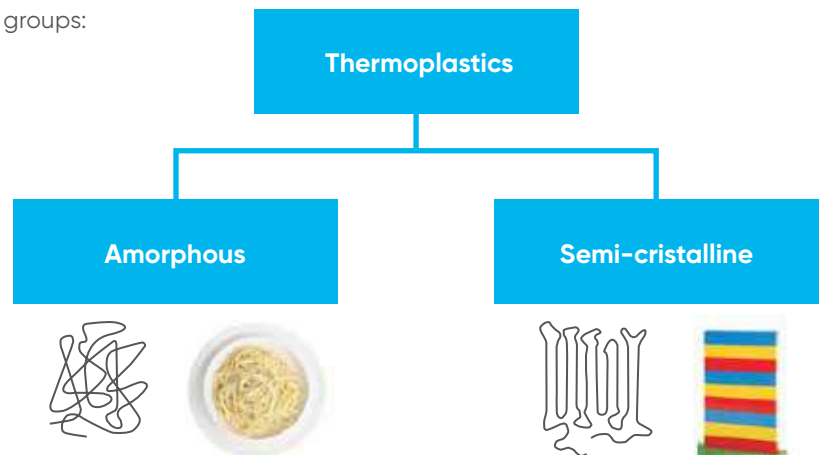

Amorphous thermoplastics

These polymers have a randomly ordered molecular structure that lack a sharp melting point. The result is that amorphous materials soften gradually as the temperature increases. These plastics dissolve and swell easily by adding solvents. Therefore, they are solvent cemented together when used in piping installations.

Common amorphous materials are usually translucent plastics.

Industrial example of amorphous materials are:

- Polyvinyl Chloride, Unplasticized (UPVC);
- Polyvinyl Chloride, Chlorinated (CPVC);
- Acrylonitrile Butadiene Styrene (ABS).

Mechanical properties of amorphous thermoplastics

The mechanical properties of plastics are temperature-dependent, particularly thermoplastics. The so-called glass condition below the glass transition temperature (T_g) is the state of temperature for the application of amorphous thermoplastic resins. In a definite shape, the molecular structure is frozen, and the mechanical properties are merely versatile and brittle.

The mechanical resistance will decrease by increased molecular mobility as the glass transition temperature is exceeded, and the resin will become soft elastic. The resin may join the liquid phase upon reaching the flow temperature (T_f). The decomposition of the molecular structure starts by hitting the decomposition temperature (T_d) within the molten phase.

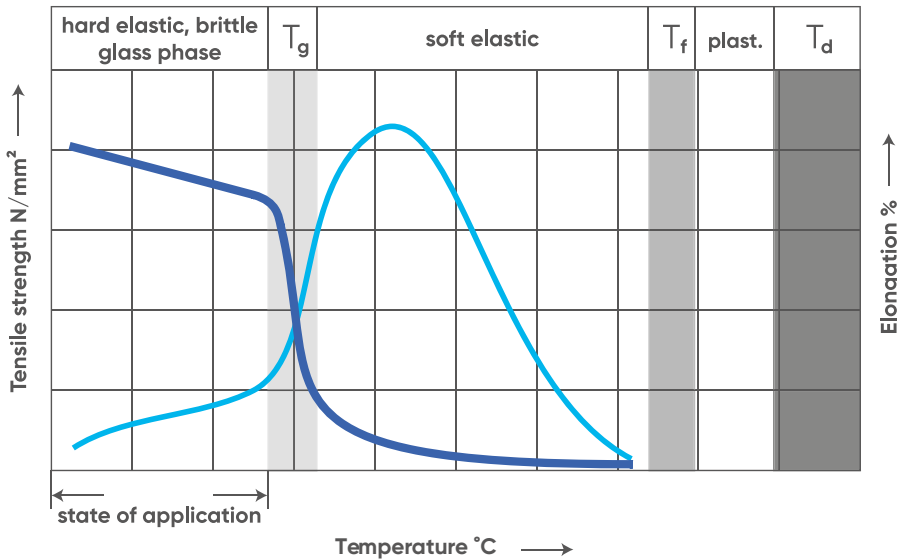

Semi-crystalline thermoplastics

Unlike amorphous thermoplastics, semi-crystalline have a highly ordered molecular structure with sharp melt points. While amorphous materials soften gradually when the temperature rises, semi-crystalline plastics do not. Instead, they remain solid until a certain quantity of heat is absorbed. The materials then quickly change into a low viscosity liquid. This melting point is generally above that of the upper range of amorphous thermoplastics.

Common semi-crystalline materials are usually opaque.

Industrial example of semi-crystalline materials are:

- Polyethylene (PE);
- Polypropylene (PP);
- Polyvinylidene fluoride (PVDF).

Mechanical properties of semi-crystalline thermoplastics

The degree of crystallization of semi-crystalline thermoplastics depends on the regularity of the configuration of the chain, the molecular weight and the mobility of the chains of the molecules, which can be hindered by loop formation.

The crystallization process can be controlled by the processing conditions. The melt's fast cooling hinders crystallization. An increased degree of crystallization will be produced by slowly cooling or tempering at the crystallization temperature. Semi-crystalline thermoplastics with a low degree of crystallisation and small phases of crystallite would be more optically translucent than products with a high degree of crystallisation and large phases of crystallite.

The amorphous form of semi-crystalline thermoplastics is frozen below the glass temperature (T_g) and the substance is brittle. The amorphous phase thaws and the amorphous phase's macromolecules achieve more stability above the glass temperature. There is also the crystalline stage and the material's mechanical nature is strong to hard elastic.

The crystalline phase also tends to melt above the crystal melt temperature (T_m) and the substance becomes malleable. As for amorphous thermoplastics, the melt-flow index (MFI) characterizes the flow capacity of semi-crystalline thermoplastics in the melted phase.

As with amorphous thermoplastics, by increasing the decomposition temperature (T_d), the deterioration of semi-crystalline thermoplastics may begin in the molten phase.

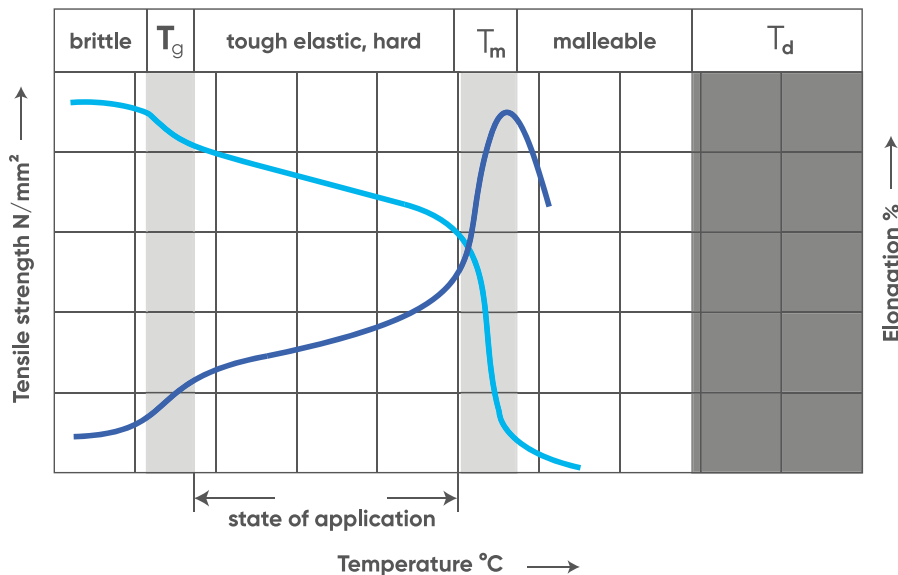

Mode of failure

Plastic materials can have two types of failures: ductile and brittle failure.

- Ductile failures are characterized by large deformations of the pipe walls, with the appearance of the typical bubble deformation around the failure zone. The process is controlled by the phenomena of creep and yielding that occur in the pipe wall: the higher the density, the lower the entity of the creep phenomena and the higher theyield strength. Ductile failure is typical of polyolefin materials.
- Brittle failure causes cracks oriented in the axial direction and do not lead to plastic deformation from the pipe wall. On a molecular basis, these breaks are the result of the disentanglement of the molecules that connect the crystalline lamellae together. Another element that influences this resistance is given by the presence of short lateral branches, which, by increasing the physical interactions between the molecules, slow down the disentanglement process. Brittle failure is typical of polyvinyl materials.

These pictures show the ductile and brittle failure modes.

The picture on the left side shows ductile failure, whereas the one on right shows brittle mode of failure.



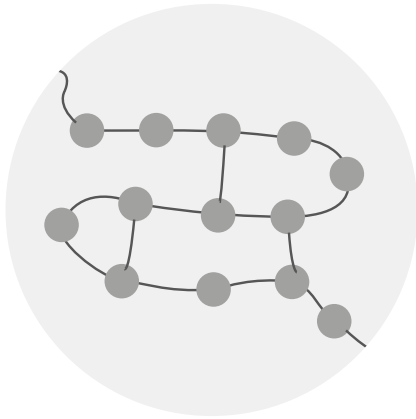

Elastomers

An elastomer is a viscoelastic polymer and has very weak intermolecular forces, generally low Young's modulus and high failure strain compared with other materials. Elastomers are those plastics with a large net-like crosslinking between the molecules.

It is an amorphous polymer maintained above their glass transition temperature, so that considerable molecular reconfirmation, without breaking of covalent bonds, is feasible. At ambient temperatures, such polymers are thus relatively compliant ($E \approx 3 \text{ MPa}$) and deformable. Their primary uses are for seals, adhesives and molded flexible parts. Application areas for different types of elastomers are manifold and cover segments as diverse as tires, soles for shoes, and damping and insulating elements.

Mechanical properties of elastomers

Elastomers cannot be melted without the composition of the molecule being degraded. Elastomers are soft elastics above the glass temperature (T_g). They are heavily elastic or brittle below (T_g). The value of the glass temperature increases with increasing number of crosslinks.

An improvement in elasticity caused by reducing the stiffening effects of the crosslinks and increasing the stability of the molecular chains is influenced by the increase in temperature. The atom bonding inside and between the molecular chains will be dissolved when the decomposition temperature (T_d) is exceeded and the substance will be chemically decomposed.

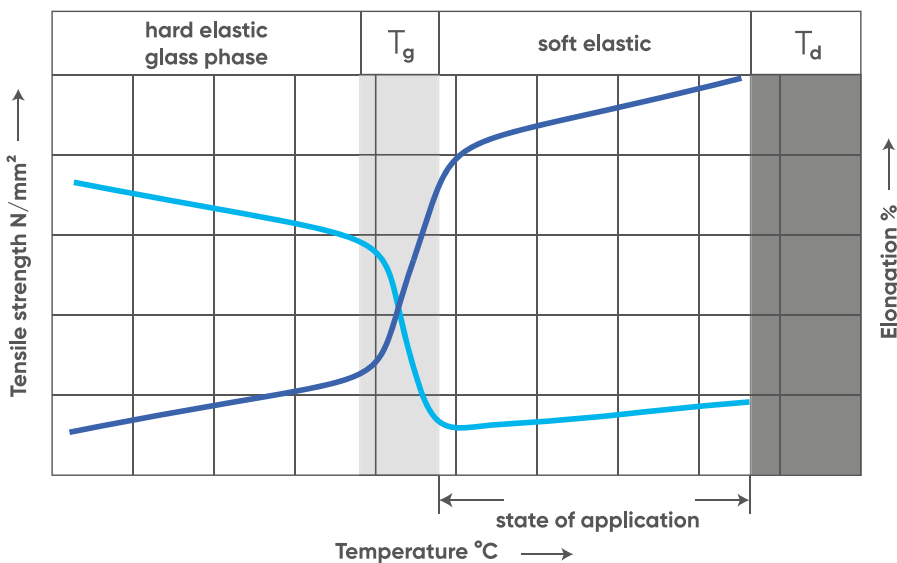

1.1.4 An overview of thermoplastics properties

The properties of a material play a vital role when it comes to specific application. Thermoplastic material offers a wide range of properties. The thermoplastics can be remolded and recycled without negatively affecting the material's physical properties. It softens when heated and becomes more fluid as additional heat is applied. The curing process is completely reversible because no chemical bonding takes place. Below are some of the examples to give an overall picture about the material properties of different thermoplastics.

Density

Density is essentially a measurement of how tightly matter is packed together. The density of any material can be calculated by dividing its total mass by its total volume and is normally expressed in g/cm^3 .

The graph on the right portrays the density of different thermoplastics.

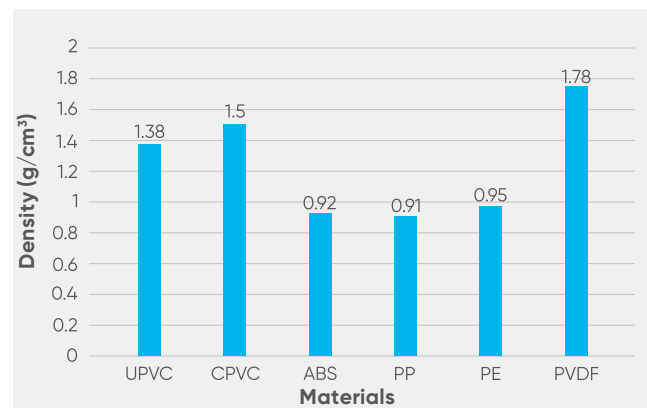

Young's modulus

"Young's modulus" or "Modulus of elasticity" is a mechanical property that measures the tensile stiffness of a solid material. It quantifies the relationship between tensile stress and axial strain in the linear elastic region of a material. It is expressed in N/mm^2 or in MPa.

The graph on the right portrays the Young's modulus values of different thermoplastics.

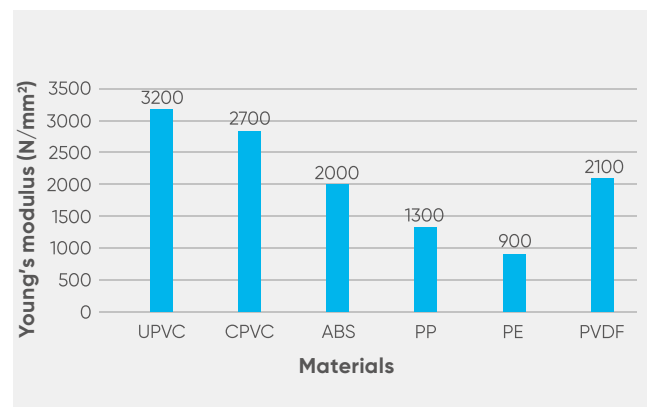

Charpy impact strength

The Charpy impact strength is an ASTM standard method of determining the impact resistance of materials. The test apparatus consists of a weighted pendulum, which is dropped from a specified height to make contact with the specimen. By measuring the difference in the height of the pendulum before and after the fracture, the energy transmitted to the substance can be calculated. It is expressed in KJ/m^2 .

The graph on the right portrays the Charpy impact strength values of different thermoplastics.

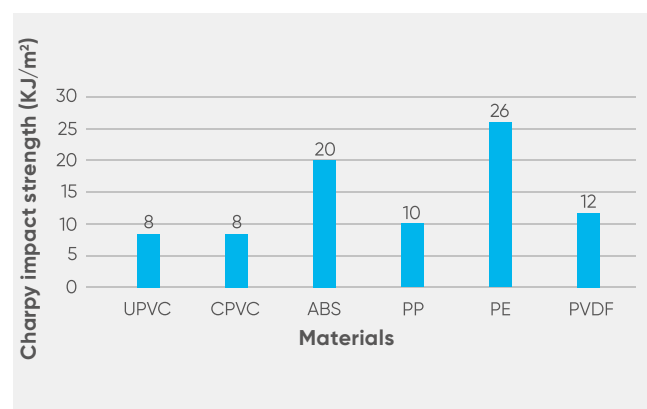

Yield strength

Similar to Charpy impact strength, tensile impact strength, often referred as "Yield strength", is also used to determine the impact energy of a material.

Yield Strength is a material's ability to resist fracture after being subjected to a sudden force. It is expressed in N/mm^2 .

The graph on the right portrays the Tensile impact strength values of different thermoplastics.

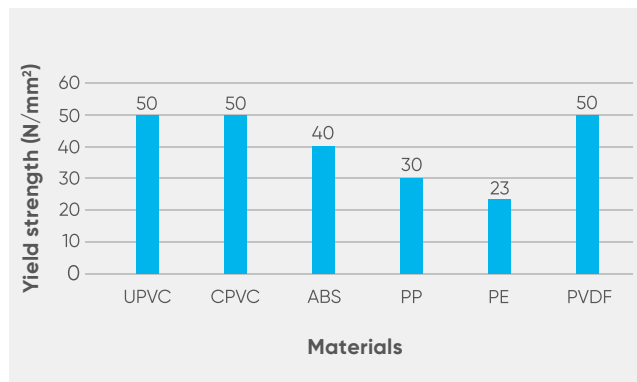

Ultimate elongation

The ultimate elongation of an engineering material is the percentage increase in length that occurs before it breaks under tension. Ultimate elongation values of several hundred percent are common for elastomers and film/packaging polyolefins. Rigid plastics, especially fiber reinforced ones, often exhibit values under 5%. The combination of high ultimate tensile strength and high elongation leads to materials of high toughness.

The graph on the right portrays the ultimate elongation values of different thermoplastics.

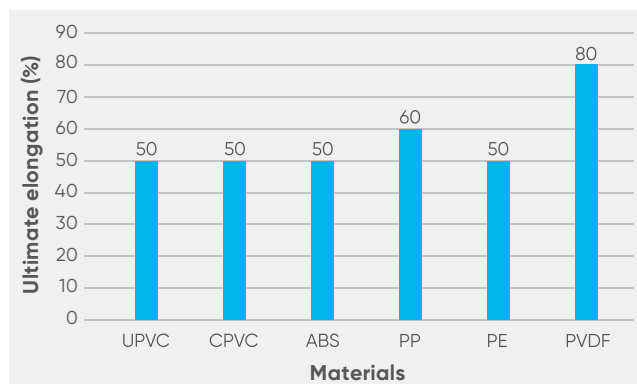

Shore D hardness

Shore D Hardness is a standardized test consisting in measuring the depth of penetration of a specific indenter.

Test methods used to measure Shore D Hardness are in compliance with standards ASTM D2240 and ISO 868.

The hardness value is determined by the penetration of the Durometer indenter foot into the sample.

Shore Hardness measures are dimensionless, values are between 0 and 100. The higher number represents the harder material.

The resulting depth is dependent on:

- Hardness of the material.
- Its viscoelasticity.
- Shape of the indenter.
- Duration of the test.

The graph on the right portrays the shore D hardness values of different thermoplastics.

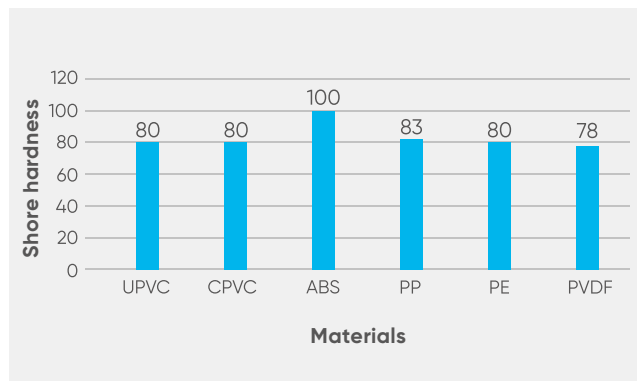

Abrasion resistance

Abrasion resistance is a property that allows a material to resist wear. The abrasion resistance of a material helps to withstand mechanical action and tends to protect the removal of materials from its surface. This allows the material to retain its integrity and hold its form.

The abrasion resistance is usually measured in total amount of weight loss (mg/cycles).

The graph on the right portrays the abrasion resistance property of different thermoplastics.

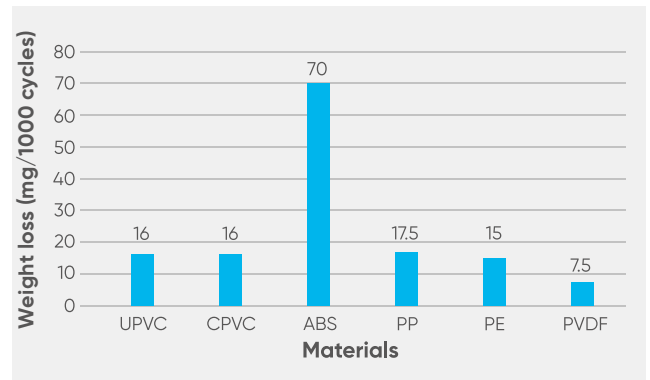

Heat Deflection Temperature (HDT)

The heat deflection temperature or heat distortion temperature (HDT) is the temperature at which a polymer or plastic sample deforms under a specified load.

The heat distortion temperature is determined by the following test procedure outlined in ASTM D648.

The test specimen is loaded in three-point bending in the edgewise direction. The outer fiber stress used for testing is either 0.455 MPa or 1.82 MPa, and the temperature is increased at 2 °C/min until the specimen deflects 0.25 mm. This is similar to the test procedure defined in the ISO 75 standard.

The graph on the right portrays the Heat Deflection Temperature (HDT) values of different thermoplastics.

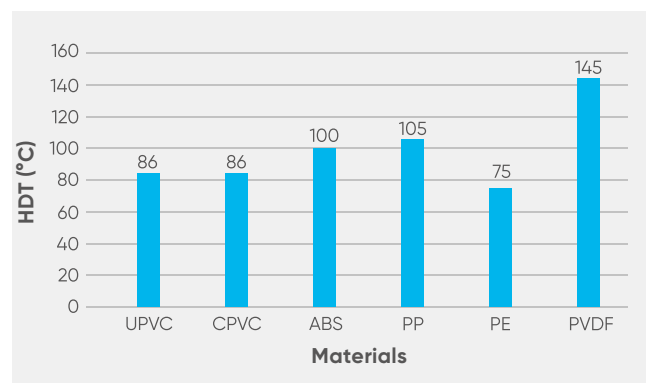

Thermal conductivity

The thermal conductivity of a material is a measure of its ability to conduct heat.

It is measured in W/(m*K) or W/(m*°C).

The graph on the right portrays the Thermal conductivity values of different thermoplastics.

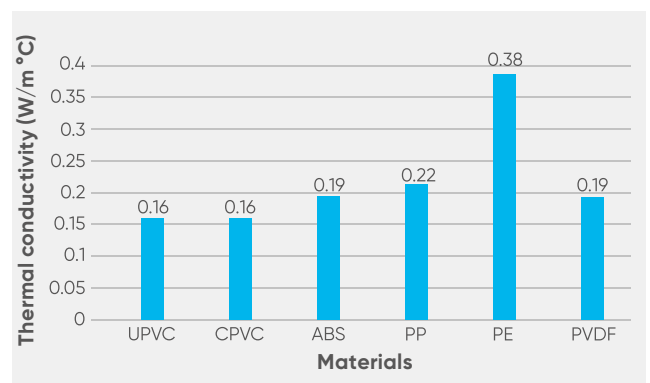

Coefficient of linear thermal expansion

Thermal expansion is the phenomenon where an object or body expands in reaction to being heated. Thermal expansion is most obvious in gasses and liquids but can still have a substantial effect on solids. It is measured in m/(m*°C).

The graph on the right portrays the coefficient of linear thermal expansion values of different thermoplastics.

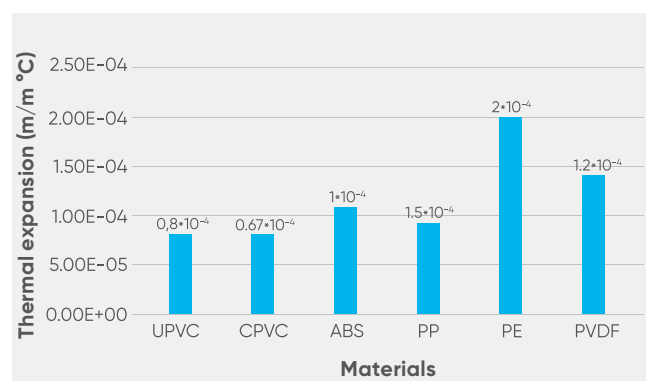

Combustion behaviour

Combustion behaviour of any material can be determined based on its oxygen index.

Thermoplastics possess good combustion properties due to its high flash point temperature, self-ignition temperature or limiting oxygen index (LOI) and so on.

The limiting oxygen index (LOI) is the minimum concentration of oxygen, expressed as a percentage, that will support combustion of a polymer. Materials with LOI values less than 21% are classified as combustible, but those with LOI greater than 21 are referred as self-extinguishing since their combustion cannot be sustained at ambient temperature without an external energy contribution. Materials with a high LOI value generally exhibit a better fire-resistant property.

The graph on the right portrays the combustion behaviour of different thermoplastics.

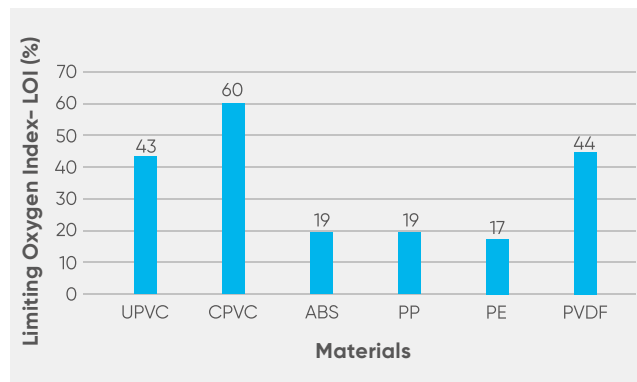

Electrical resistance

Thermoplastics are well suited for cable insulation and other electrical products due to their outstanding electrical properties. The electrical resistance of a material is measured in $\Omega \cdot m$.

The graph on the right portrays the electrical resistance property of different thermoplastics.

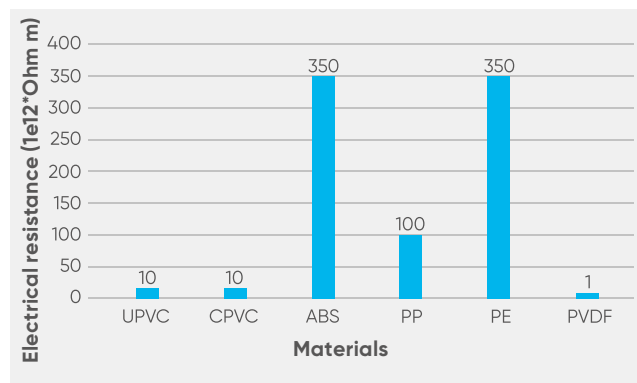

1.1.5 Advantages of using plastic over metals

The field of plastic resins is evolving dramatically. The key benefits of using plastics over metals are properties such as light weight, longevity, thermal conductivity and quicker processing.

Thanks to the fact that the plastics possess an excellent chemical and mechanical properties which makes it best choice for the use in industrial segments.

With the realization of new polymers, plastics in numerous industries such as cars, medical treatment, livestock, aerospace, and hospitality are rapidly replacing their metal counterparts.

Following are the top seven advantages of using plastics over metals for various industrial applications:

Design Flexibility

Plastics are made of different resins, each one with its own properties, but in general all plastic polymers offer an higher flexibility when compared to metals. For industries that need more options in terms of designs, textures, and geometry, plastics are a better choice.

Easy moldability while still offering metal like durability is a key advantage of plastics over metals.

Industrial parts that require complex shapes, aesthetically appealing designs or lightweight characteristics prefer opting plastics in place of metals.

Modern techniques like plastic injection moulding make it possible to create mould designs and parts that are highly complex in their geometries while offering efficiency equivalent to the metals.

Cost-Effectiveness

Plastic resin offers various advantages compared to metals. Considering the long-term benefits, plastics are more budget-friendly option when compared to their metal counterparts, as it is free from corrosion and offers greater resistance to chemical attacks.

Modern-day plastics are highly durable which makes them less likely to be damaged during shipment or use, thereby adding to the cost-effectiveness.

Lightweight

Reducing the part weight has been one of the biggest concerns for various industries like automotive, aeronautical, medical, etc. The specific density of commonly used metals is as follows:

- Aluminium: 2.5-2.8 (g/cm³).
- Brass: 8.4-8.7 (g/cm³).
- Steel: 7.7 (g/cm³).
- Zinc: 6.9-7.2 (g/cm³).
- Copper: 8.8 (g/cm³).

In comparison, plastic resins have much less specific density which makes them lightweight:

- Polycarbonate: 1.2-1.4 (g/cm³).
- Polyethylene: 0.92-0.95 (g/cm³).
- Polypropylene: 0.90-1.04 (g/cm³).
- ABS: 1.04-1.12 (g/cm³).
- Acrylic: 1.15-1.2 (g/cm³).
- PVC: 1.4 (g/cm³).
- PVDF: 1.78 (g/cm³)

The lower weight of plastic against metals influences on cost saving: Plastic pipes ensure an easier transport and consequently, a cheaper and easier installation.

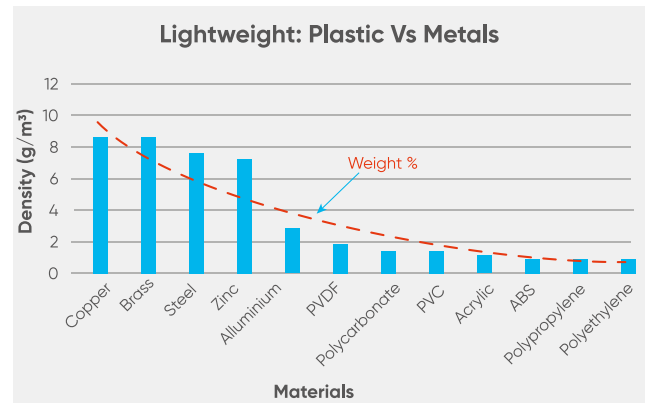

Recyclability

Plastics recycling has become more and more popular with the recent technological advancements. Nearly all thermoplastics can be reused. Used plastics can be melted and reused multiple times which makes them a more economical solution for industry owners. The total proportion of plastics being recycled varies by region around the world, with the EU coming third overall.

Life Span

The high durability of plastics to corrosion, chemical, physical, weather and environmental attacks is one of the major advantages of using plastics over metals: in fact metals are highly prone to corrosion, chemical and weather attacks which reduces their overall life span.

Safety

The production of metal parts occurs at a higher temperature than plastic: the melting point temperature of the metal is always higher than the melting point temperature of the plastic. Therefore, the manufacturing of metals requires more attention than the plastics manufacturing in terms handling the higher working temperature.

Faster Manufacturing

The plastic manufacturing process has a smaller cycle in comparison to metals.

When working with plastics, designers can incorporate multiple parts into a single mould, which reduces the overall production cycle as well as contributes to cost-effectiveness.



1.1.6 Plastics and environment

Aliaxis's Life Cycle Analyses (LCAs) ensures our commitment towards environmental care.

As a growing number of administrations and clients would like to be fully aware of the sustainable characteristics of the products they are purchasing and because we want to analyse how we can further improve our products, we created an LCA package to enable our businesses to benefit from all the LCAs we perform. We intend to provide decision-makers and architects with information packs on all our products, allowing them to make choices for a sustainable future.

These analyses confirm that our plastic pipe systems are more environmentally friendly and better alternatives to pipes made from other materials.

In addition, Aliaxis is running pilot projects in Europe and Australia, in collaboration with specialised companies and clients, to collect waste materials, recycle them and re-use those recycled materials again in production in order to obtain a closed loop recycling scheme. By doing so, we anticipate the growing expectations of customers and of society regarding the environmental characteristics of our product offering.

Energy Saving

In addition to the well-known technological benefits, such as corrosion resistance, the ecological benefits of plastics are also important. It is ideal for a range of energy-efficient applications because of its light weight and insulating properties in cars, packaging, insulation and piping systems.

In a study, Plastics Europe has quantified how energy consumption and greenhouse gas emissions affect plastic products by replacing them with other materials.

Results

Reduced greenhouse gas emissions during manufacturing

Plastic products typically require less energy to produce than alternative materials, especially in applications such as transport, building and construction, packaging and electronic devices. If plastics were to be replaced by alternative materials, their lifecycle energy consumption would be increased by around 57% and greenhouse gas emissions would rise by 61%.

The graphs given below can be used as a reference to see the amount of increase in both greenhouse gas emission and energy consumption when using the other materials over plastics.

Note: The values of average greenhouse gas emission (150 billion tonnes) and energy consumption (1200 million GJ) when using plastics were taken roughly to show how the increase in these values take into effect when using the other materials.

Greenhouse gas emission

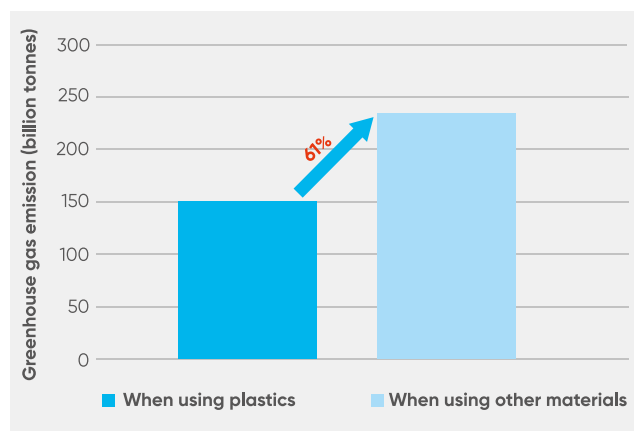

Energy consumption

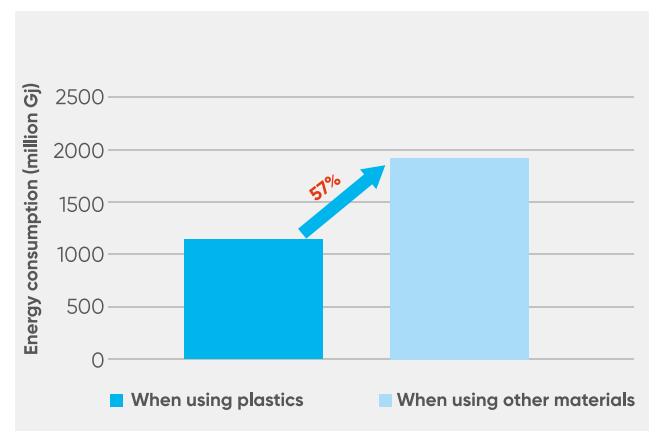

Plastics save energy in transports

The most energy efficient cars could not perform nowadays and will not exist in the future without plastics materials. In line with the objective of cutting CO₂ emissions in transport by 60% by 2050, plastics not only contribute to reducing the overall weight of the vehicle – which translates into lower fuel consumptions – but also provide the automotive industry with high performance materials which play a vital role in developing low carbon solutions such as hybrid, electric and hydrogen cars. A modern mid-range car contains up to 15% of plastic materials, from car body parts to interior trim, airbags, carpets and tyres. Plastics have also become established as a construction material for buses and trains, which saves energy, investment and maintenance costs.

Plastics save energy in building and construction

Buildings account for roughly 40% of the EU's energy consumption and greenhouse gas emissions; plastics can help to reduce this energy consumption.

9 out of 10 buildings currently in use will still be standing and occupied in 2050; therefore, both renovation of existing buildings and construction of energy efficient new buildings are necessary to meet EU objectives in this field. Plastics can play a key role, as they offer a unique combination of environmental performance, cost-effectiveness and reliability over time.

Efficient insulation

In buildings, plastics provide effective insulation from cold and heat and prevent air leakages. Plastic insulation materials consume approximately 16% less energy and emit 9% less greenhouse gases than alternative materials. Across their entire life cycle, plastic insulation boards save 150 times the energy used for their manufacture.

Renewable energy

Wind turbines' rotor blades and photovoltaic panels contain large amounts of plastics, helping to achieve the efficient production of renewable energy. In these two applications, plastics save 140 times and 340 times the emissions produced during their production respectively.

1.1.7 Manufacturing and processing methods

1.1.7.1 Polymerization

Plastics are made from raw, organic products such as cellulose, steel, natural gas, salt and, of course, crude oil.

The production of plastics starts in an oil refinery with the distillation of crude oil: the distillation splits the heavy crude oil into groups of lighter parts, called fractions. Each fraction is a mixture of hydrocarbon chains which vary in their molecular size and structure.

The key compound for the manufacture of plastics is one of these fractions, naphtha. Naphtha is broken up and converted into ethylene, propylene, butylene and other hydrocarbon compounds in a thermal cracking process.

Most of the raw materials used for this purpose come from crude oil refining, but raw materials from renewable sources are also used in some cases. Just about 4% of crude oil products coming from the refinery go to the plastics market, which is in contrary to the estimation.

Plastics are formed by linking, using a chemical bond, many related basic building blocks called monomers.

The reaction of combining these monomers to form long chains or three-dimensional networks is known as polymerization.

Polymerization can be classified into two categories:

- Step-Growth or Condensation Polymerization.
- Chain-Growth or Addition Polymerization.

Step-Growth or Condensation Polymerization

In the step growth polymerization when molecules of monomers react to form a bond, they replace some other ones that are considered the by-product of the reaction.

The type of polymers that result from a condensation polymerization depends on the monomers: if the monomer has only one reactive group, the polymers will have low molecular weight, if monomers have two reactive end groups, we will get linear polymers. Monomers with higher than two reactive groups result in a polymer with a three-dimensional network.

Polyester and nylon are two common condensation polymers, but also proteins and carbohydrates are the result of a condensation polymerization.

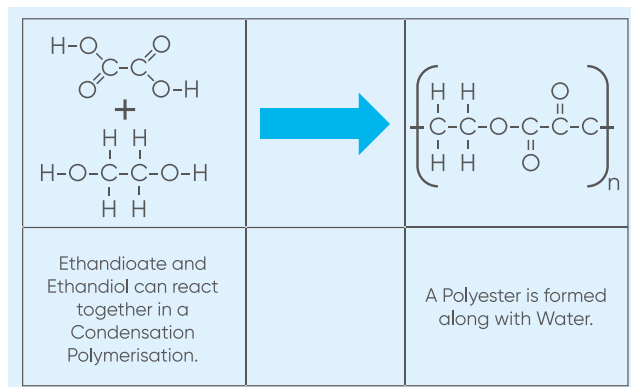

Chain-Growth or Addition Polymerization

In addition polymerization the repeating monomers rearrange themselves to form a new linear or branch structure depending on the type of monomer, but there is no loss of an atom or a molecule.

There are four types of addition polymerizations which are:

- free Radical Polymerization: the polymer is formed by the successive addition of free-radical building blocks. They join in a successive chain during free radical polymerization;
- cationic polymerization: a cationic initiator transfers charge to a monomer which then becomes reactive. This reactive monomer goes on to react similarly with other monomers to form a polymer;
- anionic Vinyl Polymerization: involves the polymerization of particularly vinyl polymers with a strong electronegative group to form a chain reaction;
- coordination Polymerization: it was developed by two scientists Ziegler and Natta who won a Nobel Prize for their work. They developed a catalyst which let us control the free radical polymerization. It produces a polymer which has more density and strength.

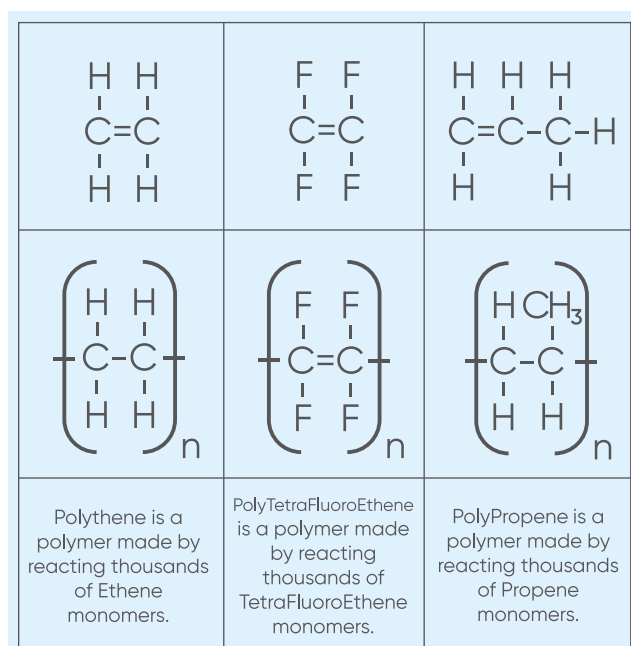

1.1.7.2 Injection and extrusion

Plastics are processed with the aid of various plastic processing machines that transform raw plastic, mostly in granular form, into semi-finished products.

The following section briefly sketches the most important plastic processing machines and explains their functions and applications in simple terms.

A variety of plastic manufacturing methods are used for Aliaxis piping systems.

A difference is made between injection moulding and extrusion: for the manufacture of fittings and valves, the injection moulding is used, for pipes the extrusion technique.

Injection molding

Injection moulding is one of the most common plastic production technique that incorporates thermoplastics. It is based on the method of molten die casting and consists of the clamping unit and the injection unit.

The process

The plastic resin is put into the hopper, which then releases the plastic pellets from the feed section into the compression section, where the frictional heat is created. The plastic is pushed through a protracted chamber using a reciprocated screw. The melted fluid-like plastic, known as melt, is forced through the nozzle into a closed, cooled/hot mould. The melt can be easily moulded into the desired shape and size of the mould.

When the mould is filled and being pressurized, part of the cooling process is performed here. Finally, the ejection cylinder or ejector pins unclamps the mould and starts pushing the part out of the mould onto a conveyor.

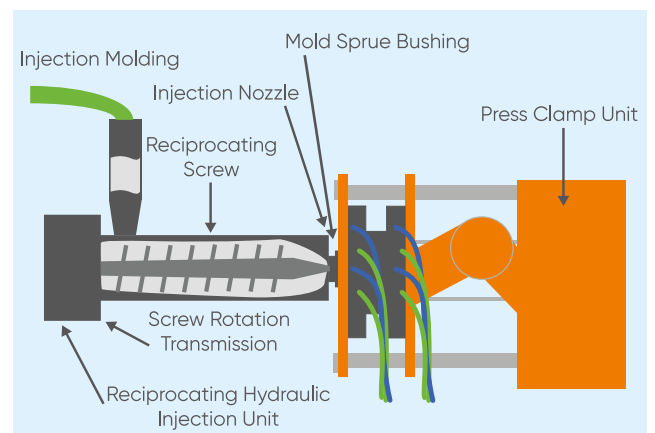

Advantages

The advantages of this process are:

- this method is used especially for making three-dimensional objects;
- minimized waste and able to recycle material;
- able to create detailed features and complex geometry;
- enhances the strength to the part after it has been moulded.

Fitting weld (knot) line

Injection moulding process can often leave a residual line/weld line, from where the mould pieces joined together.

In other words, a weld line is a visible line on a moulded fitting, both inside and out, where the plastic material fuses together during the injection moulding operation.

A weld line should not be confused with the mould parting line which also appears on a moulded fitting: the parting line is formed by the two halves of a mating mould cavity. Parting lines are usually much more visible than weld lines.

Typically, this line does not influence the overall shape or size of the component, however, depending on mould finish, material form, material colour and processing conditions, it can be visually noticeable to varying degrees.

There are many ways to make this line less visible on the moulded component, but since the injection moulding relies on a mould that has two parts, it can never be completely eliminated.

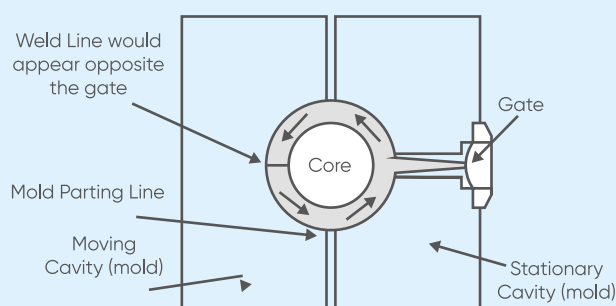

Extrusion

This technique extrudes, or forces out, materials through a die to create shapes using constant cross sections like window sections, drinking straws, pipes, and seals.

The process

Material to be melted is fed into the extruder, usually in granular form. Often, three section screws are used in standardised single-screw extruders, along with barrier screws.

The plasticised material is pressed through the die and cooled in a sizing and cooling section.

As a result of this process, the plastic, specifically the macromolecule chains, is forced into an arrangement and alignment. In technical terminology, this is called "orientation". Extrusion involves a continuous process, it uninterrupted unless the machine is switched off or not supplied with new material.

Advantages

Some of the advantages of the extrusion process are:

- shaping hard and brittle materials;
- favourable for the creation of atypical cross-sections;
- guarantees a smooth finish on the end product;
- alterations to the product after it has been removed from the extruder;
- complex shapes can be produced with varying thickness, textures, and colors.

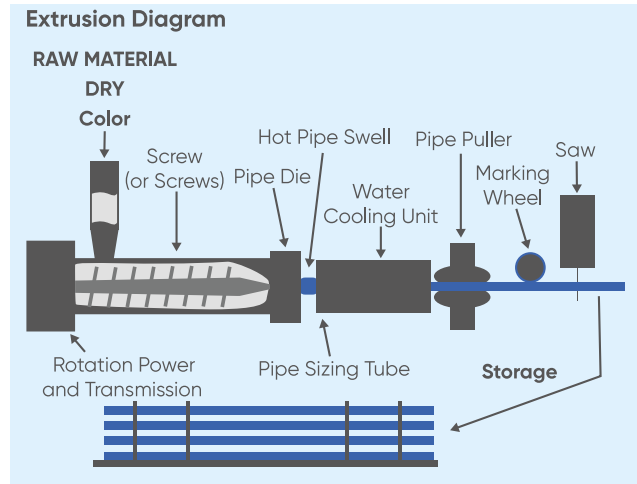

Besides injection molding and extrusion process, there are also other methods available for the processing of plastics. Which are for example, 3D printing and compression molding processing.

3D printing

3D printing is sometimes referred to as Additive Manufacturing. 3D printing could be useful in making the prototypes of the model and is an evolving technology offering various advantages. One of the key advantages of 3D printing is the ability to produce very complex shapes or geometries that would be otherwise complicated or not cost effective to construct by hand, by molding including hollow parts or parts with internal truss structures to reduce weight.

The process

A software creates an object design while the 3D printer creates the object by adding layer to layer of material until the object shape is formed.

Fused deposition modeling, or FDM, is the most common 3D printing process in use nowadays



The picture on the left shows an example of a product made with the help of a 3D printer: the black grid behind yellow position of FIP linear limit switch.

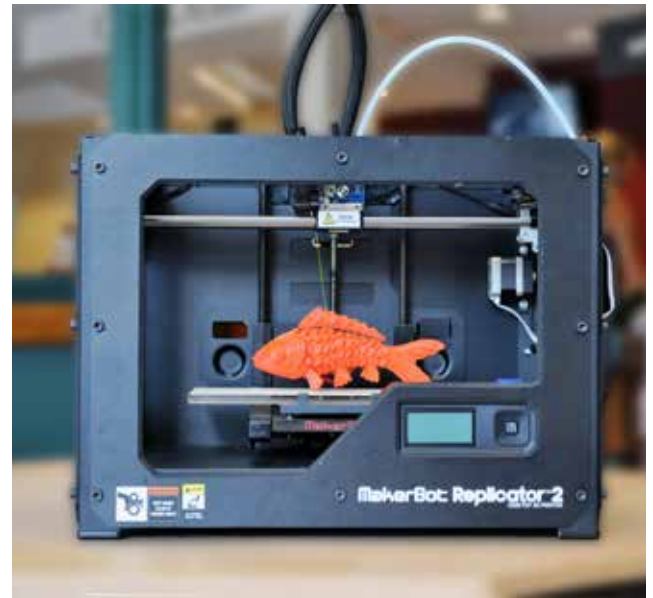

Advantages

Some of the advantages of the 3D printing process are:

- very useful for product testing as it offers a real like feeling of prototype to test it physically and to find the flaws in design;
- products with complex shapes and geometries can be easily done using 3D printing;
- less waste production;
- cost effective when this method is adopted for high numbers of batch production;
- ecological: reduced CO₂ footprint;
- cheaper than any other manufacturing solution.

Compression molding

Compression molding is a common process used for both thermoplastic and thermoset materials. However, this process is mostly used for thermoset materials in industries. Typically, thermosetting compounds like polyesters, phenolics, melamines and other resin systems are compression molded using alternating layers of different reinforcement materials to create a final product.

The process

Compression molding is accomplished by placing the plastic material (can be a granular or pelletized form) in a mold cavity to be formed by heat and pressure. The heat and pressure force the materials into all areas of the mold. The heat and pressure cycle of the process will harden the material and then it can be removed.

Advantages

Some of the advantages of the compression molding process are:

- produces extremely low or zero residual stress;
- can economically provide large parts;
- tooling costs are relatively low;
- more suitable for processing of thermoset materials.

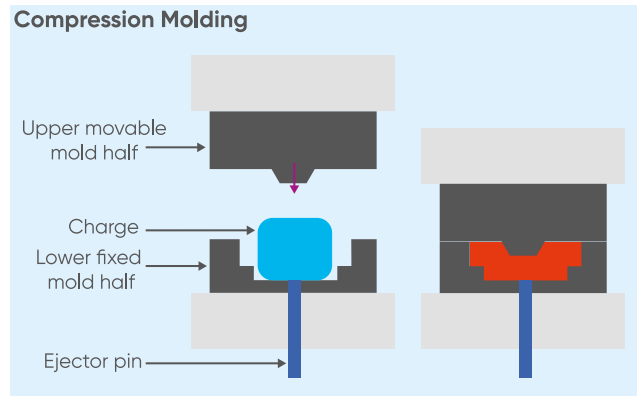

1.2 Vinyl and Styrenic polymers

1.2.1 Unplasticized Polyvinyl Chloride (UPVC)

PVC (Polyvinyl Chloride)

PVC is the world's third-most widely produced synthetic plastic polymer (after polyethylene and polypropylene). About 40 million tons of PVC are produced each year. Pure polyvinyl chloride is a white, brittle solid. It is insoluble in alcohol but slightly soluble in tetrahydrofuran.

PVC was synthesized in 1872 by German chemist Eugen Baumann after extended investigation and experimentation. The polymer appeared as a white solid inside a flask of vinyl chloride that had been left on a shelf sheltered from sunlight for four weeks. In the early 20th century, the Russian chemist Ivan Ostromislensky and Fritz Klatte of the German chemical company Griesheim-Elektron both attempted to use PVC in commercial products, but difficulties in processing the rigid, sometimes brittle polymer thwarted their efforts. Waldo Semon and the B.F. Goodrich Company developed a method in 1926 to plasticize PVC by blending it with various additives. The result was a more flexible and more easily processed material that soon achieved widespread commercial use.

In general, PVC contains approximately 56% of chlorine content. Depending on the addition of certain ingredients, different types of PVCs are formed: in Aliaxis, we offer UPVC (unplasticized PVC) and CPVC (chlorinated PVC) in high standards to meet the customer's expectations.

The different formulations obtained by adding suitable additives and stabilizers render the UPVC the most versatile of all plastic materials, allowing it to be adapted to many applications involving fluids under pressure.







UPVC represents one of the more economic solutions in the field of thermoplastic and metal materials for resolving problems in the transport of corrosive chemical fluids, and in the distribution and treatment of water in general.



In 1954, FIP was the first company to produce UPVC plastic valves.

UPVC Properties

Density	
Test method	ISO 1183 - ASTM D792
Unit of measurement	g/cm ³
Value	1.38
Modulus of elasticity	
Test method	ISO 527
Unit of measurement	MPa = N/mm ²
Value	3200
Charpy impact strength at 23°C	
Test method	ASTM D256
Unit of measurement	KJ/m ²
Value	5-8
Ultimate elongation	
Test method	ISO 527
Unit of measurement	%
Value	50
Shore hardness	
Test method	ISO 868
Unit of measurement	Shore D
Value	80
Tensile strength	
Test method	ISO 527
Unit of measurement	MPa = N/mm ²
Value	50
VICAT softening point (B/50)	
Test method	ISO 306
Unit of measurement	°C
Value	76
Heat distortion temperature HDT (0.46 N/mm²)	
Test method	ASTM D648
Unit of measurement	°C
Value	86
Thermal conductivity at 23°C	
Test method	DIN 52612-1 - ASTM C177
Unit of measurement	W/(m °C)
Value	0.16
Coefficient of linear thermal expansion	
Test method	DIN 53752 - ASTM D696
Unit of measurement	m/(m °C)
Value	8 x 10 ⁻⁵
Limiting Oxygen Index	
Test method	ISO 4859-1 - ASTM D2863
Unit of measurement	%
Value	43

Properties	Benefits	
UV and weather resistance		UPVC possess a very good weather-resistance capability. The material is barely harmed by much greater exposure to direct sunlight, wind and rain. It would be beneficial to shield the substance from excessive sunlight exposure in serious applications. For effective safety measures, contact the Aliaxis Piping Systems representative responsible.
Chemical resistance		UPVC resins have excellent chemical resistance to most acids and alkalis, paraffin/aliphatic hydrocarbons and saline solutions. It is not recommended for the transport of polar organic compounds, including some types of chlorinated and aromatic solvents. UPVC resins are also fully compatible with the transport of foodstuffs, demineralised water, potable water and unconditioned water, as provided for by current national and international standards. For specific applications see the Aliaxis's Chemical Resistance Guide.
Good thermal and Mechanical properties		UPVC resins have good thermal stability in the temperature range between 0°C and 60°C and are typically used in industrial and water supply applications, guaranteeing excellent mechanical strength, enough rigidity for the purpose, reduced thermal expansion coefficients and high factors of safety in service. UPVC resins are characterised by their low permeability to oxygen and reduced water absorption (0.1% at 23°C). The thermal stability of the material leads to good impact resistance and the capacity to support service pressures of 4, 6, 10, 16 bar at 20°C according to specific product pressure rating.
Resistance to ageing		UPVC resins have a high circumferential breaking strength (Minimum Required Strength MRS ≥ 25.0 MPa at 20°C) and allow long installation lifetimes without showing any signs of significant physical-mechanical deterioration.
Abrasion resistance		Together with new extrusion techniques, the mixing of UPVC resins, lubricants, modifiers and numerous additives in today's compounds results in a resilient piping product with outstanding abrasion resistance. As the piping material for conveyance in abrasive field UPVC is frequently chosen. Compared to other materials, the natural abrasion resistance of vinyl facilitates significant improvements in life expectancy. Installation of vinyl piping, for example, resulted in substantially less abrasion, drastically decreased maintenance and improved device longevity instead of the conventional metal or rubber-lined steel pipe for conveying mining and sand slurries.
Combustion behaviour		UPVC compounds are also resistant to combustion with a flash point temperature of 399°C. A beneficial combustion activity is due to the high chlorine content of UPVC. Self-ignition happens only at 450 °C as a result of temperature effects. As exposed to an open flame, UPVC burns, but extinguishes right after the flame is withdrawn. The oxygen index (LOI) stands at 43%. A plastic content is known to be flammable with an oxygen index below 21 %. Since the combustion of UPVC produces hydrogen chloride which, in connection with water, forms a corrosive acid, immediate cleaning of areas susceptible to corrosion is required after a burn. Thanks to the reduced coefficient of thermal conductivity ($\lambda = 0.15$ W/(m °C)) the use of UPVC resin for transporting hot fluids reduces heat loss and virtually eliminates condensation problems. Hydrochloric acid (HCl) risk to workers is negligible because its pungent odour enables early escape from poisonous combustion gases, primarily from odourless carbon monoxide.
Electrical properties		UPVC has a specific volume resistivity greater than 10^{13} $\Omega \cdot m$ and has good insulating properties.

1.2.2 Chlorinated Polyvinyl Chloride (CPVC)







In 1986, FIP were the first European Company to produce an integrated system of valves, fittings and pipes called TemperFIP100®. The result was the creation of an entire series of products for industrial plants. Today, the production of the TemperFIP line of extruded and injected moulded pipes, fittings and valves makes use of CPVC CORZAN™ resins, specifically designed for industrial applications.

CPVC resins are fully compatible for use in transporting water to treatment plants, as well as for conveying demineralised water and spa water.

The CPVC TemperFIP100® system represents one of the more economical solutions in the field of thermoplastic materials, able to resolve the difficulties encountered in process and service lines transporting hot corrosive fluids in the industrial sector, as well as in domestic hot and cold-water distribution systems.

CPVC Properties

Density	
Test method	ISO 1183 - ASTM D792
Unit of measurement	g/cm ³
Value	1.50
Modulus of elasticity	
Test method	ISO 527
Unit of measurement	MPa = N/mm ²
Value	2700
Charpy impact strength at 23°C	
Test method	ASTM D256
Unit of measurement	KJ/m ²
Value	8
Ultimate elongation	
Test method	ISO 527
Unit of measurement	%
Value	50
Shore hardness	
Test method	ISO 868
Unit of measurement	Shore D
Value	80
Tensile strength	
Test method	ISO 527
Unit of measurement	MPa = N/mm ²
Value	50
VICAT softening point (B/50)	
Test method	ISO 306
Unit of measurement	°C
Value	76
Heat distortion temperature HDT (0.46 N/mm²)	
Test method	ASTM D648
Unit of measurement	°C
Value	86
Thermal conductivity at 23° C	
Test method	DIN 52612-1 - ASTM C177
Unit of measurement	W/(m °C)
Value	0.16
Coefficient of linear thermal expansion	
Test method	DIN 53752 - ASTM D696
Unit of measurement	m/(m °C)
Value	6.7 x 10 ⁻⁵
Limiting Oxygen Index	
Test method	ISO 4859-1 - ASTM D2863
Unit of measurement	%
Value	60

Properties		Benefits
UV and weather resistance		CPVC possesses a very good weather-resistance capability. The material is barely harmed by much greater exposure to direct sunlight, wind and rain. It would be beneficial to shield the substance from excessive sunlight exposure in serious applications. For effective safety measures, contact the Aliaxis Piping Systems representative responsible.
Chemical resistance		The use of CORZAN™ resin, obtained through the chlorination of homopolymer PVC, can guarantee high chemical resistance against strong inorganic acids, saline and alkaline solutions and paraffin hydrocarbons. In addition, it possesses superior chlorine resistance at elevated temperatures. It is not recommended for the transport of polar organic compounds, including some types of chlorinated and aromatic solvents. Its electrochemical corrosion resistance guarantees excellent reliability for conveying domestic hot water in conventional and solar panel systems.
Optimum thermal and mechanical properties		TemperFIP100® CPVC is typically used in temperatures between 0°C and 85°C and has extremely low thermal expansion coefficients, thus guaranteeing excellent mechanical strength able to withstand service pressures of around 10–16 bar at 20°C. Its excellent thermal stability (VICAT value according to EN ISO 15493) together with its optimum creep behaviour, allows it to be used at temperatures up to around 95 °C for special applications and to satisfy particular performance requirements. The reduced coefficient of thermal conductivity ($\lambda = 0.16 \text{ W}/(\text{m } ^\circ\text{C})$ according to DIN 52612-1 or ASTM C177) virtually eliminates condensation problems and reduces heat loss when transporting hot fluids.
Resistance to ageing		CPVC resins are characterised by their low permeability to oxygen and reduced water absorption (0.07% at 23 °C). The physical properties of the material render it highly resistant to ageing and aggression by atmospheric agents (UV radiation) thanks to the presence of Titanium dioxide in the compound. Once properly selected for the application and correctly installed, CPVC products provide years of maintenance-free service. Our materials will not rust, pit, scale or corrode on either interior or exterior surfaces. In fact, thermoplastic piping systems in a variety of demanding industrial applications have operated successfully for over 45 years.
Abrasion resistance		Together with new extrusion techniques, the mixing of CPVC resins with lubricants, modifiers and numerous additives in today's compounds results in a resilient piping product with outstanding abrasion resistance. As the piping material for conveyance in abrasive field, PVC and CPVC are frequently chosen. Compared to other materials, the natural abrasion resistance of vinyl facilitates significant improvements in life expectancy. Vinyls outperform other materials, such as steel, in many uses. Installation of vinyl piping, for example, resulted in substantially less abrasion, drastically decreased maintenance and improved device longevity instead of the conventional metal or rubber-lined steel pipe for conveying mining and sand slurries.
Combustion behaviour		CPVC demonstrates remarkably good combustion behaviour without the inclusion of flame retardants due to its high chlorine content. At temperatures exceeding 400 °C, CPVC self-ignites. As exposed to an open flame, CPVC burns, but extinguishes instantly when the flame is removed. The oxygen index is 60 % (plastic is known to be flammable with less than 21 % oxygen). Since the combustion of CPVC produces hydrogen chloride which, in combination with water, forms a corrosive acid, immediate cleaning of areas susceptible to detergent-containing water corrosion is important after a burn. The risk to workers due to hydrochloric acid is small and its pungent odour requires identification even at the lowest concentrations (1 ppm to 5 ppm), allowing for an early escape of harmful combustion gases, primarily from odourless carbon monoxide. Water, carbon dioxide or foam are the preferred fire-fighting substances.
Electrical properties		CPVC is non-conductive, much as all unmodified thermoplastics. In CPVC systems, this suggests that no electrochemical corrosion takes place. CPVC has a specific volume resistivity greater than $10^{13} \Omega \cdot \text{m}$ and has good insulating properties.

1.2.3 Acrylonitrile-Butadiene-Styrene (ABS)

Acrylonitrile Butadiene Styrene (ABS) is a common thermoplastic polymer. Its glass transition temperature is approximately 105°C. ABS is amorphous and therefore has no true melting point.



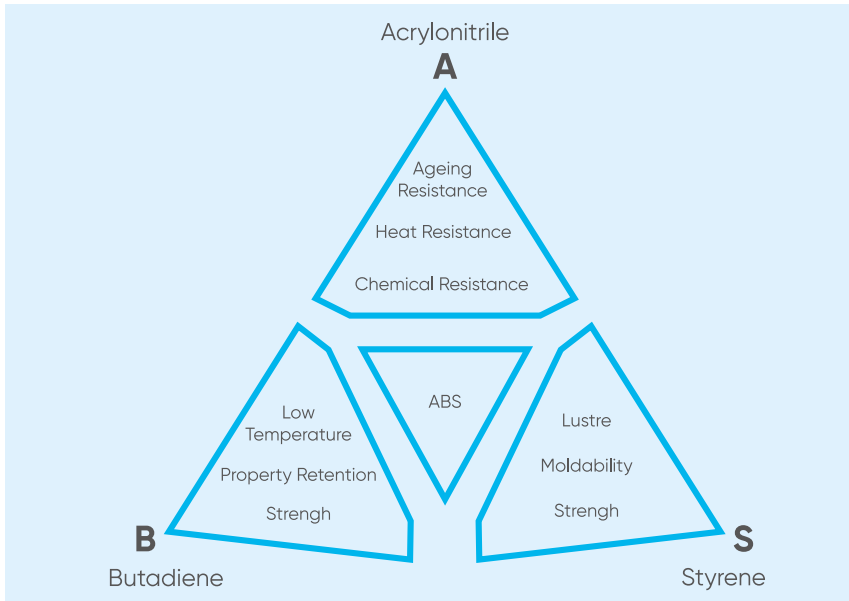



ABS is derived from acrylonitrile, butadiene, and styrene. Acrylonitrile is a synthetic monomer produced from propylene and ammonia; butadiene is a petroleum hydrocarbon obtained from the C4 fraction of steam cracking; styrene monomer is made by dehydrogenation of ethyl benzene – a hydrocarbon obtained in the reaction of ethylene and benzene.



The proportions can vary from 15 to 35% acrylonitrile, 5 to 30% butadiene and 40 to 60% styrene. The nitrile groups from neighbouring chains, being polar, attract each other and bind the chains together, making ABS stronger than pure polystyrene. The styrene gives the plastic a shiny, impervious surface. The polybutadiene, a rubbery substance, provides toughness even at low temperatures. For most applications, ABS can be used between -40 °C and 60 °C as its mechanical properties vary with temperature. The properties are created by rubber toughening, where fine particles of elastomer are distributed throughout the rigid matrix.

ABS Properties

Density	
Test method	EN ISO 1183-1
Unit of measurement	g/cm ³
Value	0.925
Modulus of elasticity	
Test method	ISO 527, ASTM D638
Unit of measurement	MPa = N/mm ²
Value	2000
Charpy impact strength at 23°C	
Test method	ISO 179/1eA, ISO 180/1A – ASTM D256
Unit of measurement	KJ/m ²
Value	20
Ultimate elongation	
Test method	ISO 527
Unit of measurement	%
Value	50
Shore hardness	
Test method	ISO 868
Unit of measurement	Shore D
Value	100
Tensile strength	
Test method	ISO 527, ASTM D638
Unit of measurement	MPa = N/mm ²
Value	40
VICAT softening point (B/50)	
Test method	ISO 306
Unit of measurement	°C
Value	≥87
Heat distortion temperature HDT (0.46 N/mm²)	
Test method	ISO 75, ASTM D648
Unit of measurement	°C
Value	100
Thermal conductivity at 23°C	
Test method	DIN 52612-1 – ASTM C177
Unit of measurement	W/(m °C)
Value	0.19
Coefficient of linear thermal expansion	
Test method	DIN 53752 – ASTM D696
Unit of measurement	m/(m °C)
Value	10 x 10 ⁻⁵
Limiting Oxygen Index	
Test method	IISO 4859-1 – ASTM D2863
Unit of measurement	%
Value	19

Properties	Benefits	
UV and weather resistance		If, over a long period of time, the ABS piping system is exposed to direct sunlight, its surface loses its shine and the colour shifts to light grey. The resulting loss of toughness generally causes no problems in moderate climatic zones due to the very high impact strength of ABS. We nevertheless recommend protecting the surface from direct sunlight for extreme weather conditions or very high loads on the piping system.
Chemical resistance		ABS have a good resistant to chemical degradation, either by alkaline or acidic agents. The chemical stability of ABS lies in the strong chemical bonding as apparent in its structure: the polar attraction between nitrile groups, the aromatic chains in the styrene group, and the hydrocarbon backbone. The strong chemical bonds also provide a degree of thermal stability to the plastic, keeping it from breaking down even at high temperatures. For most applications, ABS can be used between $-40\text{ }^{\circ}\text{C}$ to $60\text{ }^{\circ}\text{C}$.
Optimum thermal and mechanical properties		Thermal properties in chilled water and secondary loop refrigeration are very important to a systems efficiency. Traditional materials like copper or steel are very good conductors and have a thermal conductivity of $413\text{ W}/(\text{m}^{\circ}\text{K})$ and $54\text{ W}/(\text{m}^{\circ}\text{K})$, respectively. This inherent material property causes them to conduct heat very effectively, diminishing the efficiency of a cooling system. Another common problem when using conductive materials for cooling applications is the need for lagging or wrapping to prevent the pipe from sweating. ABS is a non-conductive material and acts as an insulator with a thermal conductivity of $0,25\text{ W}/(\text{m}^{\circ}\text{K})$. This material property allows for greater process efficiency when used in a cooling system and often eliminates the need for lagging to prevent the pipe from sweating. When a large temperature difference is found between the cooling liquid and the outside temperature, and/or there is a high relative humidity, lagging may be needed even for ABS.
Abrasion resistance		In addition to the excellent impact strength, the components of butadiene rubber in ABS have an excellent abrasion resistance effect. Piping systems made of ABS have long been used for solids and slurries, such as those found in mining, because of this property. Compared to metals, ABS provide important advantages for many of these applications.
Mode of Failure		ABS is a ductile material with a mode of failure that resembles soft copper. Failure is by ductile distortion and tearing and is localized in nature, which minimizes the loss of the pipe contents. In contrast, the failure of a rigid material is accompanied by rapid crack propagation and hazardous material fragmentation. Depending on the conditions involved, this rapid fragmentation type of failure can rip through many lengths of pipe, including valves and fittings. This mode of failure can be accentuated by adverse conditions such as water hammer, prolonged exposure to sunlight, cold contents or cold ambient temperatures and non-compatibility of the pipe with its contents (e.g. compressed air, gases or unsuitable chemicals).
Combustion behaviour		At temperatures exceeding $450\text{ }^{\circ}\text{C}$, ABS self-ignite. When exposed to an open flame, ABS burn, and the material continues to burn even after removing the flame. The oxygen index stands at 19%. Carbon monoxide and water are formed when ABS burn, primarily carbon dioxide. Tests have shown that the relative toxicity of combustion products is like, or even lower than, that of natural products such as wood, cotton and wool. Combustion gases from ABS are not corrosive. Nonetheless, the combustion forms soot. Suitable fire-fighting agents are water, foam and carbon dioxide.
Electrical properties		ABS is not conductive, like most thermoplastics. In ABS systems, this implies that no electrochemical corrosion takes place. ABS provide good electrical insulation properties. $3,5\ 10^{14}\ \Omega\cdot\text{m}$ is the specific volume resistance.

1.3 Polyolefins and Fluorinated polymers

Polyolefin

A polyolefin is a type of polymer produced from a simple olefin as a monomer. For example, polyethylene is the polyolefin produced by polymerizing the olefin ethylene. Polypropylene is another common polyolefin which is made from the olefin propylene.

Most polyolefins produced on an industrial scale are made via polymerization through the use of catalysts. There are four major types of polyolefin catalysts, namely: chromium-based catalysts, Ziegler–Natta catalysts, metallocene single-site catalysts (SSC), and post-metallocene SSC.

All four categories are important for polyethylene, but the last three categories of catalysts are far more relevant for polypropylenes.

Fluorinated polymers

With regard to their chemical, thermal and electrical stability, fluorinated polymers exhibit very fascinating properties: their inertness to acids, bases, solvents and oils, their low constant and refractive dielectric indexes, their high resistance to ageing and oxidation, and their low surface tension, which makes them very hydrophobic in nature. In addition, usually, they are not flammable, which is a particularly fascinating aspect. Because fluorinated polymers contain a broad variety of thermoplastic and elastomeric materials ranging from semi-crystalline to completely amorphous, they are used in various applications.

1.3.1 Polypropylene (PP)

Polypropylene is a thermoplastic and partially crystalline resin belonging to the family of polyolefins.

PP is obtained through the chain-growth polymerization of propylene (C_3H_6) with the aid of catalysts.

For use in piping systems, the latest-generation Polypropylene Homopolymer variant, or PP-H, offers excellent performance at working temperatures of up to 80 °C and a high resistance to chemicals due to the excellent physical and thermal characteristics of the resin.

Polypropylene is the second-most widely produced commodity plastic after polyethylene.

The chemical formula of polypropylene is $(C_3H_6)_n$, it is derived from polymerization of propylene monomer by:

- Ziegler-Natta polymerization.
- Metallocene catalysis polymerization.

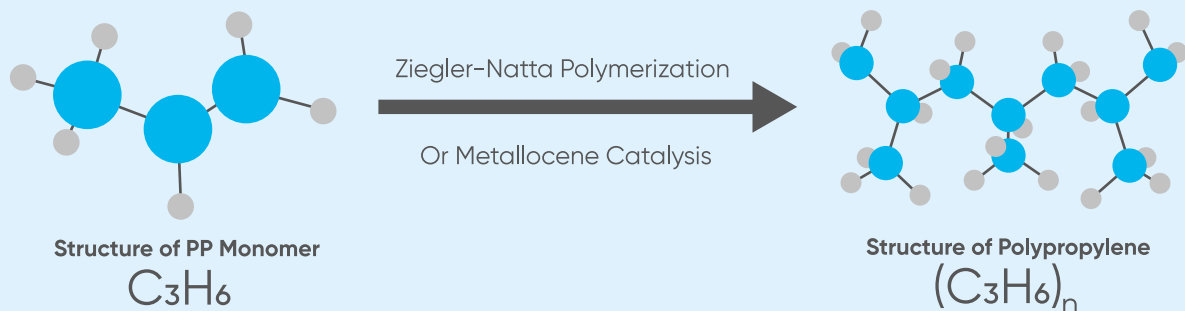

Based on the polymerisation process and molecular structure, polypropylene can be further classified into many groups.

The polypropylene tree given below will be useful in understanding the different varieties of polypropylene.

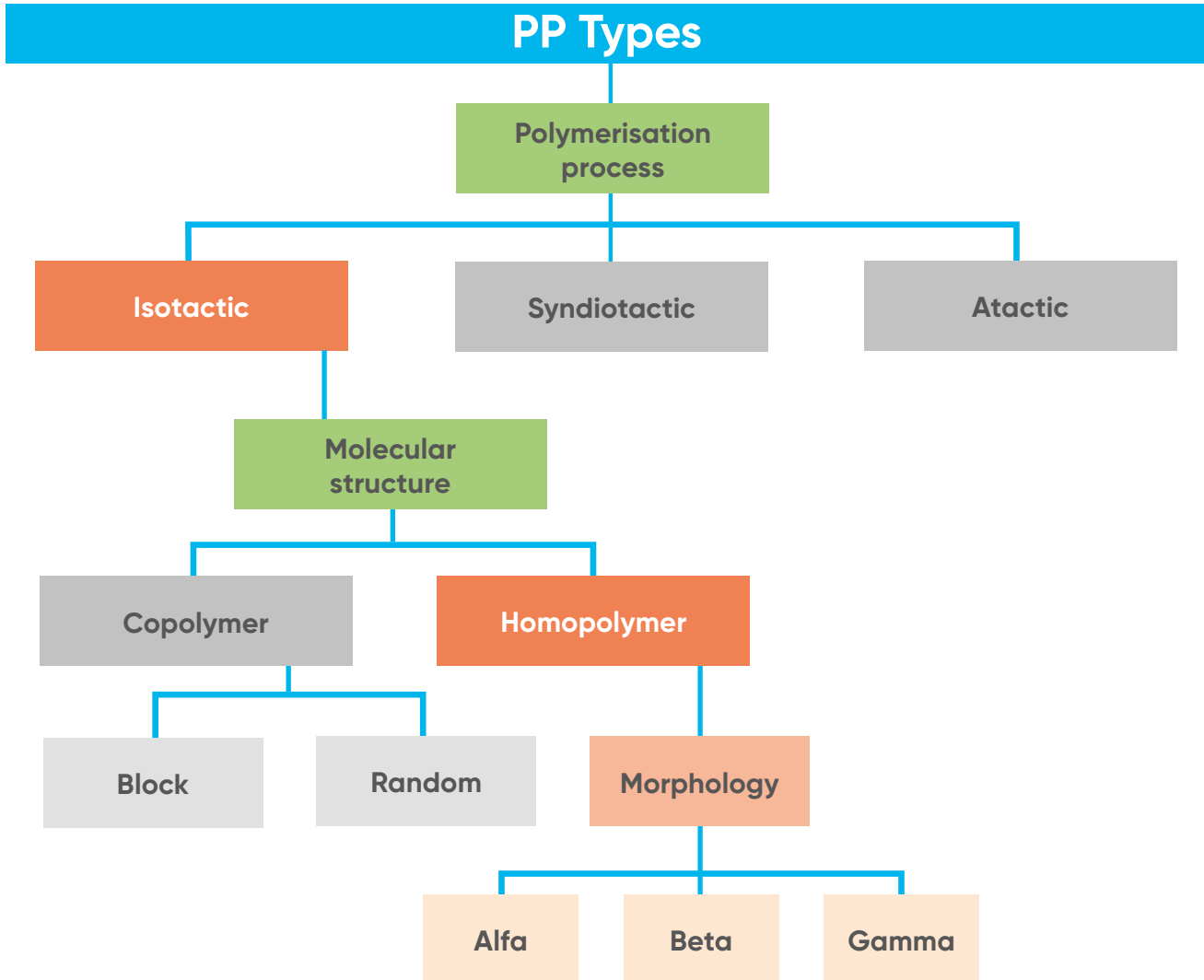

The position of the methyl group in the basic structure of polypropylene decides which group it belongs to:

- atactic polypropylene (aPP);
- syndiotactic polypropylene (sPP);
- isotactic polypropylene (iPP).

The methyl group ($-\text{CH}_3$) is randomly aligned in the case of atactic polypropylene, alternating with syndiotactic polypropylene and evenly with isotactic polypropylene.

Isotactic polypropylene has a high degree of crystallinity, which is 30–60% in consumer goods.

Syndiotactic polypropylene is much less crystalline, whereas atactic belongs to amorphous (non-crystalline) family of materials.

Atactic PP belongs to amorphous and has the mechanical properties of a non-vulcanised rubber.

It is used widely in industries for the coating of carpet backing, as a hot-melt adhesive and as a sealing compound.

Syndiotactic PP are inferior to isotactic and since it is difficult to manufacture it is not produced on an industrial scale.

Isotactic PP possess a great amount of crystallinity due to its helix structure. It is used widely in the construction of engineering apparatus.

Isotactic PP: CH_3 groups on the same side of the main chain

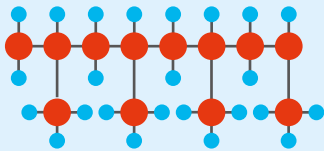

Syndiotactic PP: CH_3 groups strictly alternate on opposite sides of the main chain

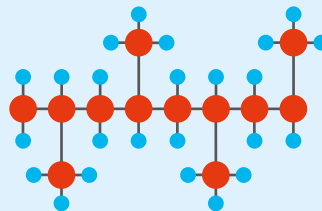

Atactic PP: Statistical distribution of CH_3 groups around the main chain

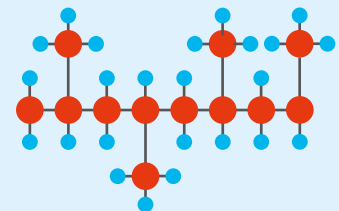

The picture clearly portrays the distinction between atactic, syndiotactic and isotactic PP.

Based on the crystallinity, isotactic PP can divide into three categories.

When cooled off from the melt, the molecules of isotactic PP will, at the melting point, start to organize into crystals. Three crystals symmetries are known for isotactic PP-H:

- α (monoclinic): without the addition of nucleating agents;
- β (pseudohexagonal): with the addition of nucleating agents;
- γ (triclinic): symmetry can arise in low molecular weight PP at high temperatures and is not of interest for practical applications in piping systems.

The different crystalline forms are produced by adding special nucleating agents to the PP-H moulding compounds.

Based on the Propylene, and Ethylene-Propylene unit in PP matrix, it can be identified into three different categories namely:

- Homo-Polymer (PP-H);
- Random-Copolymer (PP-R);
- Block-Copolymer (PP-B).

Homo-Polymer (PP-H)



Random-Copolymer (PP-R)



Block-Copolymer (PP-B)



PP-H Matrix Propylene











Ethylene - Propylene Rubber Ethylene Unit



The picture could be useful in understanding the PP matrix and its propylene, ethylene-propylene unit in different PP types.

Polypropylene (PP) properties

Density	
Test method	DIN EN 1183
Unit of measurement	g/cm ³
Value	0.91
Modulus of elasticity	
Test method	ISO 527
Unit of measurement	MPa = N/mm ²
Value	1300
Charpy impact strength at 23°C	
Test method	DIN EN ISO 179, ASTM D256
Unit of measurement	kJ/m ²
Value	7
Ultimate elongation	
Test method	ISO 527
Unit of measurement	%
Value	60
Shore hardness	
Test method	ISO 868
Unit of measurement	Shore D
Value	83
Tensile strength	
Test method	ISO 527
Unit of measurement	MPa = N/mm ²
Value	30
VICAT softening point (B/50)	
Test method	ISO 306
Unit of measurement	°C
Value	152
Heat distortion temperature HDT (0.46 N/mm²)	
Test method	ASTM D648
Unit of measurement	°C
Value	95-105
Thermal conductivity at 23°C	
Test method	EN 12664
Unit of measurement	W/(m °C)
Value	0.22
Coefficient of linear thermal expansion	
Test method	DIN 53752 - ASTM D696
Unit of measurement	m/(m °C)
Value	1.5 x 10 ⁻⁴
Limiting Oxygen Index	
Test method	ISO 4589-1 - ASTM D2863
Unit of measurement	%
Value	17.5

Properties		Benefits
UV and weather resistance		All polyolefins are subjected to degrading by ultraviolet radiation. PP is predominantly not suitable against longer acting UV radiation and must be protected in all applications. For pipelines with impact-like internal pressure loads, the wall temperature should not fall below 5 °C. For effective safety measures, contact the Aliaxis Piping Systems representative responsible.
Chemical resistance		Polyethylene has a chemical composition comparable to polyethylene PE-HD resistance. Due to its non-polar characteristic, it has especially a very good resistance to water, salt solutions, acids, alkalis, alcohols and many organic solvents at increased operating temperatures. It also has a limited resistance to aromatic compounds and cannot be used with strong oxidizing agents. PP swells in aliphatic and aromatic hydrocarbons. The chemical resistance depends on many factors. The most important influences on the chemical resistance are the operating temperature, the duration of exposure, and the concentration and composition of mixtures. Please contact us regarding the material resistance against specific chemicals or chemical mixtures.
Optimum thermal and mechanical properties		PP-H and PP-R can be used in a wide temperature range with regard to applications in plastic pipeline construction. In such cases, the duration of the temperature effect should be of most importance. It ensures greater service life if it is used between the temperature range of 0 °C to 95 °C. Regarding the internal pressure load capacity of pipes, fittings and armatures under the simultaneous influence of temperature, refer PN diagrams of the respective material.
Resistance to ageing		PP-H and PP-R resins have a high circumferential breaking strength (Minimum Required Strength MRS ≥ 10.0 MPa at 20°C) and allow long installation lifetimes without showing any signs of significant physical-mechanical deterioration.
Abrasion resistance		PP shows a very good amount of resistance against abrasion. It shows high abrasion resistance to mechanical stresses, especially against friction. PP is less likely to corrode in exposed and buried pipes. Thus, it ensures extremely low operating costs due to its long service life.
Mode of failure		Polypropylene is known for its high amount of ductility and impact resistance. Due to its great ductile property, PP exhibits ductile failure most of the time. However, at elevated temperatures, a quasi-brittle fracture can occur.
Combustion behaviour		Polypropylene is a plastic which is flammable. When exposed to an open flame, it burns and the material continues to burn without soot after removing the flame. The oxygen index stands at 19%. (Materials that burn less than 21% of the air's oxygen are considered flammable). Carbon monoxide and water are formed when it burns, primarily carbon dioxide.
Electrical properties		PP is a non-polar hydrocarbon polymer with excellent insulation properties. However, since the electrical charges cannot be dissipated, PP has a tendency also for electrostatic charging. Therefore, PP may be not used for applications where there is a risk of ignition and/or explosion, or only under certain requirements it can be used. It possesses a specific volume resistance value of $10^{14} \Omega \cdot m$.

Polypropylene homopolymer (PP-H)

The most commonly used general-purpose grade is Polypropylene Homopolymer. In a semi-crystalline stable form, it comprises only propylene monomer. Packaging, textiles, healthcare, piping, automotive and electrical applications are the primary applications.

The latest generation of polypropylene, the Polypropylene Homopolymer, consists of a comprehensive range of pipes, fittings and valves for use in the construction of process and service lines for conveying pressurised industrial fluids and for maximum operating temperatures of up to 95° C.

The production of the PP-H is carried out according to the highest quality standards and in full compliance with the environmental restrictions set by the applicable laws in force and in accordance with ISO 14001.

All products are made in accordance with the quality guarantee system in compliance with ISO 9001.

The Copolymer family of polypropylene is further divided into random copolymers and block copolymers formed by propene and ethane polymerization.

Polypropylene Random Copolymer (PP-R)

Polypropylene Random Copolymer (PP-R) is processed by polymerizing ethene and propene together. It features Ethene units inserted randomly in the polypropylene chains, typically up to 7% by mass.

PP-R is mainly suitable for thermal shock applications, where the temperature ranges between hot and cold. For instance, PP-R is ideal in hot and cold-water application. In addition, as PP-R providing an excellent corrosion resistance and offering an ideal alternative to copper and steel tube.

Polypropylene Block Copolymer (PP-B)

Polypropylene Block Copolymer (PP-B) contains greater ethene content (between 5 and 15%). It has co-monomer units grouped in a regular sequence. Therefore, the usual pattern makes the thermoplastic harder and less porous than the spontaneous co-polymer. These polymers are suitable for applications with high strength requirements, such as automotive applications.

Polypropylene Electrically conductive (PP-EL)

PP-EL provide more safety due to their low flammability. In addition, to use polypropylene for electrically conductive applications, graphite is added to the basic polypropylene resin. Thus, it ensures the suitability of polypropylene material for the usage in electrically conductive applications.

In the case of flames, in association with electrical conductivity, the optimal protection of fire is offered by PP-EL.

The table below could be useful to understand the disparities among PP-H, PP-R and PP-B.

Properties	Materials		
	PP-H	PP-R	PP-B
Density (g/cm ³)	0.905 to 0.915	0.900 to 0.910	0.900 to 0.910
Minimum Required Strength – MRS (N/mm ²)	≥10	≥8	≥8
Young's modulus (N/mm ²)	1300	1100	900
Impact strength @ 23°C (KJ/m ²)	65	52	31
Shore-D hardness	72	67	62
VICAT softening point temperature (°C)	93	70	69
Melt Flow Rate – MFR (g/10min)	0.3 ≤MFR ≤1	0.3 ≤MFR ≤1	0.3 ≤MFR ≤1

1.3.2 Polyethylene (PE)

Polyethylene or polythene is a semi-crystalline thermoplastic material which belongs to Polyolefins group.

Polyethylene (PE) is the most common plastic in use today. As of 2017, over 100 million tonnes of polyethylene resins are manufactured annually, representing 34% of the global demand for plastics.

Aliaxis PE-HD pressure pipes are ideal for applications in all areas of industrial plant engineering. Further main fields of application are the transport of industrial and domestic wastewater, wastewater treatment and water purification in sewage plants as well as various applications in swimming pools.

Further, the mechanical properties of polyethylene are essentially dependent on density, degree of crystallization and the manufacturing process, which is reflected in the variety of types. Polyethylene of low density is extruded using high pressure and high temperature, while polyethylene of high density is extruded using low pressure and low temperature. An essential distinguishing feature consists in the main groups:

- High Density Polyethylene, PE-HD (Density: 0.94 - 0.965 g/cm³).
- Medium density polyethylene, PE-MD (Density: 0.93 - 0.94 g/cm³).
- Low density polyethylene, PE-LD (Density: 0.9 - 0.91 g/cm³).
- Cross-linked polyethylene, PEX.

Many kinds of polyethylene are known, with most having the chemical formula (C₂H₄)_n. PE is commonly a mixture of identical ethylene polymers, with varying values of n.



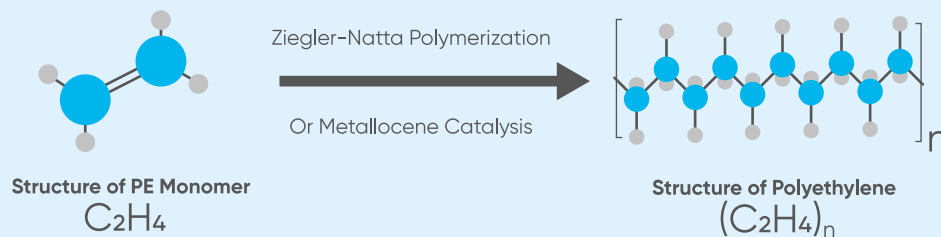





Polyethylene is made by addition or radical polymerization of ethylene (olefin) monomers. Polymerization of polyethylene is carried out by Ziegler-Natta and Metallocene catalysts.



The picture illustrates how polyethylene is being formed from its base molecule ethylene through the polymerisation process.

Polyethylene (PE) properties

Density	
Test method	DIN EN 1183
Unit of measurement	g/cm ³
Value	0.95
Modulus of elasticity	
Test method	ISO 527, ASTM D 790
Unit of measurement	MPa = N/mm ²
Value	900
Charpy impact strength at 23°C	
Test method	ASTM D256
Unit of measurement	KJ/m ²
Value	16-26
Ultimate elongation	
Test method	ISO 527
Unit of measurement	%
Value	50
Shore hardness	
Test method	ISO 868
Unit of measurement	Shore D
Value	80
Tensile strength	
Test method	ISO 527
Unit of measurement	MPa = N/mm ²
Value	23
VICAT softening point (B/50)	
Test method	ISO 306
Unit of measurement	°C
Value	127
Heat distortion temperature HDT (0.46 N/mm²)	
Test method	ASTM D648
Unit of measurement	°C
Value	75
Thermal conductivity at 23°C	
Test method	EN 12664
Unit of measurement	W/(m °C)
Value	0.38
Coefficient of linear thermal expansion	
Test method	DIN 53752 - ASTM D696
Unit of measurement	m/(m °C)
Value	20 x 10 ⁻⁵
Limiting Oxygen Index	
Test method	ISO 4589-1 - ASTM D2863
Unit of measurement	%
Value	17

Properties		Benefits
UV and weather resistance		Especially black coloured PE-HD pipes are suitable for long-term outdoor use. The use of carbon black additives avoids the effects of prolonged exposure to intense UV light. This ensures the suitability of PE to use in an open environment.
Chemical resistance		PE-HD has comprehensive chemical resistance. Due to its non-polar nature, PE-HD has good resistance to water, salt solutions, acids, alkalis, alcohols and many organic solvents, even at elevated operating temperatures. Conditional resistance is present with aromatics, PE-HD cannot be used with strong oxidizing agents. The chemical resistance depends on many factors: the most important influences are the operating temperature, the duration of exposure, and the concentration and composition of mixtures. Please contact us regarding the material resistance against specific chemicals or chemical mixtures.
Optimum thermal and mechanical properties		According to literature, PE-HD can be used in the temperature range from - 40 °C to +60 °C, ensuring that the material has excellent mechanical properties in a wide range of applications. Regarding the internal pressure load capacity of pipes, fittings and armatures under the simultaneous influence of temperature, refer to PN diagrams of the respective material.
Resistance to ageing		PE-100 resins have a high circumferential breaking strength (Minimum Required Strength MRS ≥ 10.0 MPa at 20°C) and allow long installation lifetimes without showing any signs of significant physical-mechanical deterioration. New pipes made of PE-HD certificated for DIN 8075, DIN 16892 have an operation time of minimum 100 years.
Abrasion resistance		PE shows a very good amount of resistance against abrasion. It shows high abrasion resistance to mechanical stresses, especially against friction. PE is less likely to corrode in exposed and buried pipes. Thus, it ensures extremely low operating costs due to its long service life.
Mode of failure		Generally, PE exhibits the mode of failure, which is brittle, initiation of slow crack growth (SCG) through the pipe wall. These cracks can initiate at microscopic stress-raising flaws, inherent in the basic pipe product or, more likely, from defects. However, over the years, PE has evolved and now provide a strong combination of strength, rigidity, reliability and longevity in line with long-term gas and water pressure needs, ground loading and the service environment. If this material is rapidly pulled apart, it breaks in a brittle fashion. However, once the material is gradually pulled apart, it acts in a ductile fashion and can be stretched nearly forever. In the last 50 years, the material development in PE is remarkable and PE-RC is evident to it. Thus, it shows a significant resistance against slow crack growth, being a very good material option for long-term application needs.
Combustion behaviour		Polyethylene is a plastic material which is flammable. When exposed to an open flame, PE burns and the material continues to burn without soot after removing the flame. The oxygen index stands at 17%. (Materials that burn less than 21% of the air's oxygen are considered flammable). Carbon monoxide and water are formed when PE burns, primarily carbon dioxide.
Electrical properties		PE-HD is a non-polar hydrocarbon polymer with excellent insulation properties. It possesses a specific volume resistance value of $3.5 \cdot 10^{14} \Omega \cdot \text{m}$. However, since the electrical charges cannot be dissipated, PE-HD also tends to become electrostatically charged. For this reason, PE-HD must not be used in applications with a risk of ignition and/or explosion, or only under certain conditions. For more details refer DVS Guidelines 2210-1.

The polyethylene designations

The continuous development and improvement of plastic also influences its mechanical properties and variables. These are continuously improved due to years of practical experience, as well as efforts in the research departments of pipe manufacturers in improving the capacity of plastic.

Improvements in the mechanical properties of the polyolefin used in plastic pipe construction primarily involve PE compounds.

Associated with changes in material characteristics are corresponding changes in material designations. In plastic pipe construction, reference is no longer made to PE-HD but to the PE types PE63, PE80 and PE100.

It must, however, be noted that only PE100 is, in fact, used widely in this field. The digits indicate the long-term stability of the material, a conventional practice in labelling metal materials. The long-term stability for PE100 is calculated as follows: $\text{ref} = 100/10 = 10 \text{ MPa} = 10 \text{ N/mm}^2$ and applies to situations where the flow medium is water at 20°C and the load period 50 years. The MRS value is determined by analysing long term pipe tests in accordance with ISO 9080 and then categorized in accordance with ISO 12162.

- PE63 \geq MRS 6.3,
- PE80 \geq MRS 8.0,
- PE100 \geq MRS 10.0.

Since PE63 has smaller creep strength than PE80 and PE100, it has only limited applications in pressure pipe systems. In terms of strength values, PE80 largely corresponds to PE-HD with partial improvements of material properties.

Polyethylene 100 (PE-100)

The use of PE100 is increasingly more common in pipe construction, especially in areas involving high pressure due to its greater strength. Initial suspicions with regard to welding have been dispelled, so that manufacturers and contractors can widely benefit from the advantages of PE100.

Standards and application guidelines have been updated so that any impediments in them no longer exist. The new bimodular types of PE80 and PE100 demonstrate, in addition to improvements in strength properties, greater resilience than PE-HD, a quality improvement that yields the following benefits:

- greater creep strength at higher temperatures;
- greater resistance to rapid crack growth;
- reduced susceptibility to notching.

In terms of the service life of the bimodular types, evidence to support assuming it to be 100 years is provided by the standard extrapolation method specified in ISO 9080.

Another important factor involved in more use of PE100 is, it can be welded without restriction. Welding of PE100 onto PE80 components can also be performed unrestricted. In case of application of welded fittings, a reduced pressure load made from pipe must be taken in account.

Polyethylene Random Crack Resistance (PE-RC)

PE 100-RC is a modern resin and 'RC' stands for 'crack resistance.'

That means PE 100-RC is resistant to slow propagation of cracks and point load. The figure below demonstrates a significant disparity among PE 100-RC and other PE resins.

PE 100-RC also has the well-known and advantageous properties of PE 100 and the same installation schemes can be used. The essential features of PE resins are shown by the corresponding style.

The increased resistance of PE 100-RC is beneficial in many aspects. Below are some of the examples where PE 100-RC stands superior to other PE varieties:

- application areas involve demanding installation techniques: Open-trench without sand bedding for cost reduction, Horizontal Directional Drilling (HDD), Relining, pipe bursting, etc. are some of the example application areas where using PE 100-RC would be an ideal option;
- application areas which creates certain constraints to pipes: External scratch, rock impingement (point-load), pipe under stress, etc are some of the example application areas where using PE 100-RC would be an ideal option.

Using PE 100-RC results not only in cost saving potential but also yields environmental and sustainability benefits.

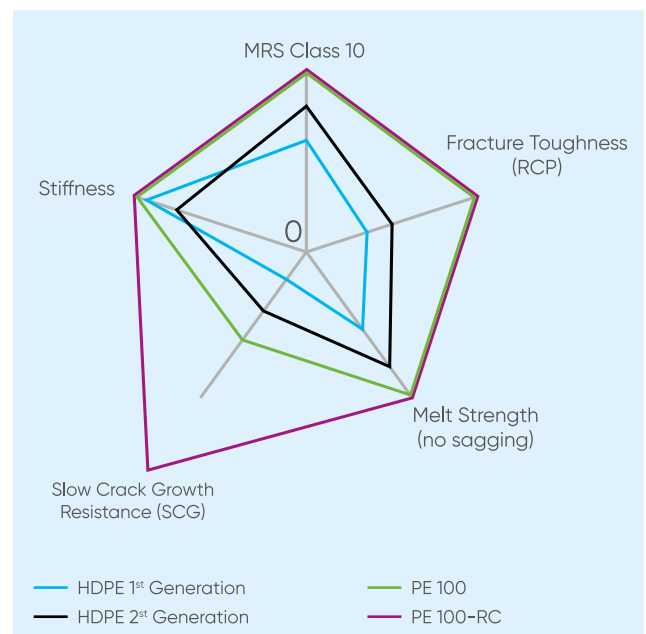

1.3.3 Polyvinylidene fluoride (PVDF)

PVDF (polyvinylidene difluoride) is a fluorinated and semi-crystalline techno polymer containing 59% of its weight in fluorine. This material is obtained through the polymerization of vinylidene fluoride and corresponds to the following chemical formula: $(C_2H_2F_2)_n$.

It boasts exceptional mechanical, physical and chemical resistance, guaranteeing excellent thermal stability up to 140°C.

Thanks to its high purity and exceptional performance, PVDF is the best alternative to metal materials, and is extensively used in industrial applications (chemical, oil, pharmaceutical, pulp and paper, electronic, etc.).





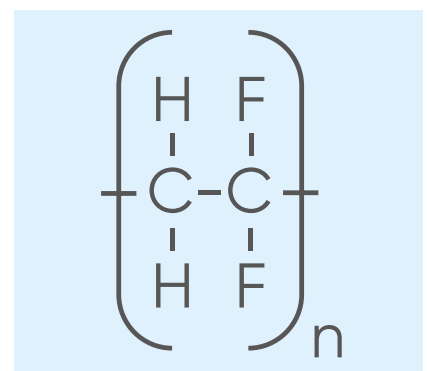



PVDF resin is an extremely pure polymer that does not contain stabilizers, plasticizers, lubricants or flame retardants. As a result, it is the ideal material for conveying ultra-pure water and chemicals, ensuring the non-contamination of the conveyed fluid. As it is physiologically non-toxic, it is suitable for conveying fluids and food products.

Among the most important properties and advantages of PVDF, the following are particularly worthy of note.

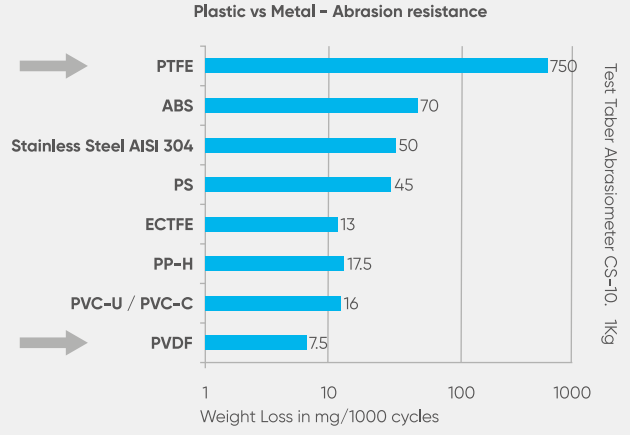

PVDF Properties

Density	
Test method	ISO 1183 - ASTM D792
Unit of measurement	g/cm ³
Value	1.78
Modulus of elasticity	
Test method	ISO 527, ASTM D 790
Unit of measurement	MPa = N/mm ²
Value	2100
Charpy impact strength at 23°C	
Test method	ASTM D256
Unit of measurement	KJ/m ²
Value	12
Ultimate elongation	
Test method	ISO 527
Unit of measurement	%
Value	80
Shore hardness	
Test method	ISO 868
Unit of measurement	Shore D
Value	78
Tensile strength	
Test method	ISO 527
Unit of measurement	MPa = N/mm ²
Value	50
VICAT softening point (B/50)	
Test method	ISO 306
Unit of measurement	°C
Value	138
Heat distortion temperature HDT (0.46 N/mm²)	
Test method	ASTM D648
Unit of measurement	°C
Value	145
Thermal conductivity at 23°C	
Test method	DIN 52612-1 - ASTM C177
Unit of measurement	W/(m °C)
Value	0.19
Coefficient of linear thermal expansion	
Test method	DIN 53752 - ASTM D696
Unit of measurement	m/(m °C)
Value	12 x 10 ⁻⁵
Limiting Oxygen Index	
Test method	ISO 4859-1 - ASTM D2863
Unit of measurement	%
Value	44

Properties	Benefits																			
<p>UV and weather resistance</p> 	<p>Polyvinylidene fluoride (PVDF) demonstrates intrinsic resistance characteristics, especially against ozone oxidation reactions and UV degradation. The chemical stability of PVDF's carbon and fluoride as well as the polymeric interaction of PVDF during its manufacturing leads to this resistance. Especially, the PVDF material that we are using offers excellent intrinsic resistance to natural aging and do not require anti-UV additives.</p>																			
<p>Chemical resistance</p> 	<p>The use of PVDF resin, a vinylidene fluoride polymer, ensures excellent resistance to corrosion and abrasion when conveying highly aggressive chemicals. PVDF is basically inert to most inorganic acids, organic acids, aromatic and aliphatic hydrocarbons, alcohols and halogenated solvents. However, it is generally not recommended for use with amines, ketones, strong alkaline (e.g. caustic soda) and oleum (sulfuric acid with sulphur trioxide). Please contact us regarding the material resistance against specific chemicals or chemical mixtures.</p>																			
<p>Optimum thermal and mechanical properties</p> 	<p>PVDF maintains its characteristics unchanged in a temperature range between -40°C and +140°C. PVDF pipes are particularly suitable in all applications requiring high operating temperatures, very low levels of fluid contamination and high resistance to ageing due to atmospheric agents and UV radiation. The material's excellent mechanical properties are retained even at high temperatures.</p>																			
<p>Resistance to ageing</p> 	<p>PVDF resins have a huge circumferential breaking strength (Minimum Required Strength MRS ≥ 25 MPa at 20°C) and allow long installation lifetimes without showing any signs of significant physical-mechanical deterioration. In addition, Fluoropolymers generally have greater thermal stability than their hydrocarbon counterparts. This stability is due to the high electronegativity of the fluorine atom and thus to the high dissociation energy of the C-F bond. PVDF has an excellent resistance to long-term thermal aging up to a temperature of 150°C.</p>																			
<p>Abrasion resistance</p> 	<p>According to the Taber Abrasion Test (in which the weight loss of a material is measured after being exposed to an abrasive wheel for 1000 cycles), PVDF is the most resistant thermoplastic material (CS-10 Load 1kg - Weight Loss / 1000 cycles = 5-10 mg). The picture below clearly portrays the high abrasion resistance capability of PVDF over other materials. PVDF shows only 7.5 mg of material loss for 1000 cycles, whereas all the other materials undergo huge material damage.</p>	 <table border="1"> <caption>Plastic vs Metal - Abrasion resistance</caption> <thead> <tr> <th>Material</th> <th>Weight Loss in mg/1000 cycles</th> </tr> </thead> <tbody> <tr> <td>PTFE</td> <td>750</td> </tr> <tr> <td>ABS</td> <td>70</td> </tr> <tr> <td>Stainless Steel AISI 304</td> <td>50</td> </tr> <tr> <td>PS</td> <td>45</td> </tr> <tr> <td>ECTFE</td> <td>13</td> </tr> <tr> <td>PP-H</td> <td>17.5</td> </tr> <tr> <td>PVC-U / PVC-C</td> <td>16</td> </tr> <tr> <td>PVDF</td> <td>7.5</td> </tr> </tbody> </table> <p>Test: Taber Abrasiometer CS-10, 1kg</p>	Material	Weight Loss in mg/1000 cycles	PTFE	750	ABS	70	Stainless Steel AISI 304	50	PS	45	ECTFE	13	PP-H	17.5	PVC-U / PVC-C	16	PVDF	7.5
Material	Weight Loss in mg/1000 cycles																			
PTFE	750																			
ABS	70																			
Stainless Steel AISI 304	50																			
PS	45																			
ECTFE	13																			
PP-H	17.5																			
PVC-U / PVC-C	16																			
PVDF	7.5																			
<p>Mode of failure</p> 	<p>Two distinct failure modes are shown by PVDF pipes under constant pressure at a high temperature. Due to localization of the deformation and development of a blister, pipes collapse in the ductile fashion under average hoop stress greater than a critical value (σ_c). PVDF shows different failure behaviour under average hoop stress lesser than a critical value (σ_c). The gradual and localized propagation of a very tiny crack through the pipe wall characterizes this regime. While it is often referred to as "brittle" since no macroscopic plastic deformation near the fracture zone is detected.</p>																			
<p>Combustion behaviour</p> 	<p>PVDF resins guarantee excellent fire resistance without the need for flame retardants. Its oxygen index value stands at 44% (Limiting Oxygen Index, LOI = 44%). Since ordinary air contains roughly 21 % oxygen, a material whose oxygen index is appreciably higher than 21 is considered flame resistant because it will only burn in an oxygen-enriched atmosphere. In case of combustion, smoke emissions are moderated. PVDF resins are classified UL-94, class V-O.</p>																			
<p>Electrical properties</p> 	<p>PVDF is a material which is non-conductive, like all the other unmodified thermoplastics. In PVDF systems, this suggests that no electrochemical corrosion takes place. However, this non-conductive behaviour may lead to the formation of electrostatic charges. In environments in which explosive gases can occur, special attention must be given to this reality. Moreover, it possesses a specific volume resistance value which is greater than $10^{12} \Omega \cdot m$. Please contact us in case of help in choosing the correct material for piping installation.</p>																			

1.4 Rubber

Rubber is an organic (typically cis-1,4-polyisoprene) polymer of Isoprene. It is a hydrocarbon polymer that appears in the sap of different plants and can also be synthetically developed as milky latex.

Based on the method it's being produced/derived, rubbers can be classified into two types namely:

- Natural Rubber.
- Synthetic Rubber.

Natural rubber

Natural rubber is an elastomer and a thermoplastic. Once the rubber is vulcanized, it is a thermoset. Most rubber in everyday use is vulcanized to a point where it shares properties of both.

Natural rubber is obtained from the Latex sap of trees which is an elastic material. The rubber molecules present in these latex tubes are made up of 5 carbon and 8 hydrogen atoms. These rubber molecules are joined with each other to form long, chain-like structure. This chain of rubber molecules is called polymers that gives rubber its property of elasticity.

Natural rubber also has a small proportion (about 5%) of other components, such as fats, fatty acids, resins and inorganic products (salts).

The final properties of a rubber item depend not just on the polymer, but also on modifiers and fillers, such as carbon black, factice, whiting and others.

Synthetic Rubber

Synthetic Rubber is a rubber which can be produced artificially. It is possible to describe an elastomer as a substance possessing the property of elasticity. Thus, synthetic rubber is the type of rubber manufactured from chemicals to serve as a replacement for natural rubber. There are different kinds of polymers used to produce forms of synthetic rubber. As a result, various types of synthetic rubbers have varying properties that are adapted to the needs of the sectors of rubber products.

Below are some of the common types of synthetic rubbers that are used in different industries:

- Polychloroprene (CR),
- Styrene-Butadiene (SBR),
- Ethylene Propylene Diene Monomer (EPDM),
- Acrylonitrile Butadiene (NBR),
- Polysiloxane (SI),
- Fluoroelastomer (FKM),
- Perfluoroelastomer (FFKM),
- Chlorosulphonated Polyethylene (CSM).

In Aliaxis, we are mainly using the following two kinds of rubber:

- Ethylene Propylene Diene Monomer (EPDM),
- Fluoroelastomer (FKM).

Besides, we also offer Perfluoroelastomer (FFKM) which can be available on our industrial valves on request to cover specific industrial process needs. Some of our STRAUB couplings that we are offering uses Acrylonitrile Butadiene (NBR) as a gasket material.

1.4.1 Acrylonitrile Butadiene (NBR)

Acrylonitrile butadiene rubber is a synthetic rubber derived from acrylonitrile (ACN) and butadiene. NBR contains polar nitrile side groups on the polymer backbone. These do not interact to any extent with non-polar liquids such as petrol, oil and lubricants, and so the material is not susceptible to swelling in these media. Therefore, acrylonitrile-butadiene rubber differs from other rubbers through its media resistance. The more acrylonitrile the rubber contains, the better its resistance to chemicals such as mineral oils and fuels and to hot water. Other benefits of NBR are its good mechanical performance profile and low gas permeability.

Nitrile rubber is non-sparking because of its low static charge, so it is commonly used for hydraulic hoses, fuel lines, seals and O-rings in oil-lubricated machines. Another important area of use is oil and gas exploration. NBR is used mainly as a gasket material in industrial applications.

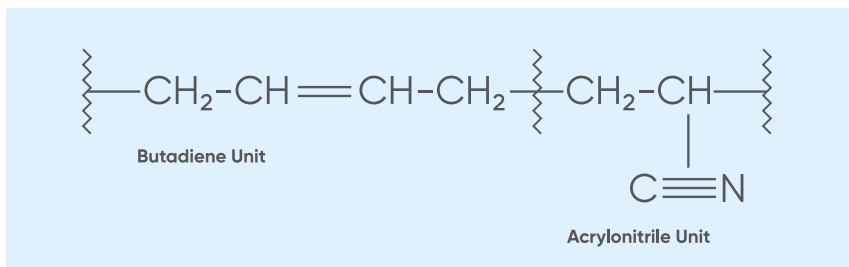

The picture shows the chemical structure of NBR.

Advantages of NBR

- Offers good chemical resistance to mineral oils, fuels, lubricants, alcohols and vegetable and animal fats and oils.
- Thermal application range, depending on compound formulation: -50 to $+100^\circ\text{C}$.
- Good mechanical properties.
- Good electrical conductivity because of its polarity.

Applications of NBR

- Seals and O-rings.
- Gaskets.
- Automotive industries.
- NBR is used as a base material for laboratory and surgical gloves and for the chemical proofing of textiles.

1.4.2 Ethylene Propylene Diene Monomer (EPDM)

EPDM rubber or Ethylene propylene diene monomer rubber is one of the most popular types of synthetic rubber. EPDM rubber is an elastomer, a high-density rubber that has a wide variety of uses and is very durable. It consists of ethylene, propylene, and a diene comonomer that enables crosslinking via Sulphur vulcanization.

It is a semi-crystalline material with ethylene-type crystal structures at higher ethylene contents, becoming essentially amorphous at ethylene contents that approach 50 wt%.

There are some inherent features of this rubber which make it particularly suitable for electrical insulation, gaskets and lamination. Today's polymerization and catalyst technologies provide the opportunity to develop EPDM rubber to fulfil precise and challenging criteria for production and processing.

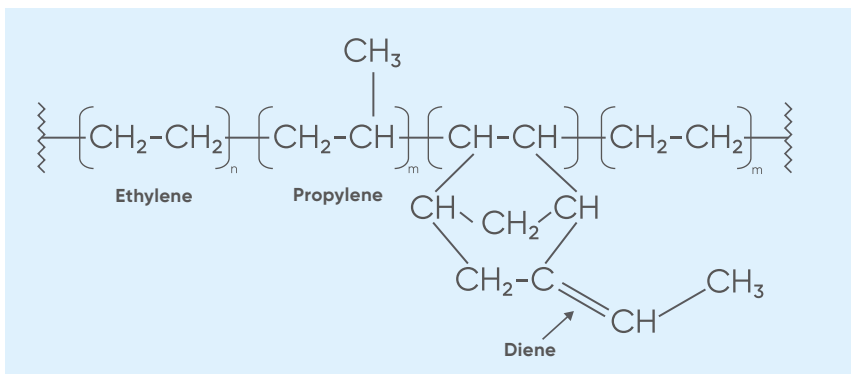

Advantages of EPDM rubber

- EPDM rubber has outstanding resistance to atmospheric oxidation, which ensures that it is resistant to sun, ozone and temperature.
- It has strong resistance to most chemicals that are water-based and alkaline fluids.
- The tolerance of EPDM rubber to abrasives and tearing is also good.
- It has good electrical resistivity.
- EPDM rubber is also resistant to polar solvents like water, acids, alkalis, phosphate esters.
- At high and low temperatures, it has exceptional flexibility. EPDM has a temperature range of -50°C to $+120^{\circ}/150^{\circ}\text{C}$, depending on the curing system.

Applications of EPDM

Since EPDM rubber does not crack outdoors, it is commonly used in buildings and in the automotive industry for seals. The steam hose, high temperature-resistant seals and roll covers are some other applications. Today's polymerization and catalyst technologies provide the opportunity to develop EPDM rubber to fulfil precise and challenging criteria for production and processing.

This has contributed to the large use of EPDM rubber in the following sectors:

- Valve seal O-ring and diaphragm.
- Flange and stub end gaskets.
- Automotive weather-stripping and seals.
- Tubing.
- Electrical insulation.
- Roofing membrane.
- Rubber mechanical goods.

1.4.3 Fluoroelastomer (FKM)

FKM (fluorocarbon) is a synthetic rubber belongs to a family of fluoroelastomer. All FKMs contain vinylidene fluoride as a monomer.

Fluoroelastomers are more expensive than rubber elastomers made of neoprene or nitrile, but they provide additional heat and chemical resistance. Based on either their chemical structure, their fluorine content or their mechanism of crosslinking, FKMs can be classified into separate groups:

Type 1 FKMs are composed of vinylidene fluoride (VDF) and hexafluoropropylene (HFP). The typical category of FKMs that display good overall efficiency are copolymers. The fluorine content is about 66% by weight.

Type 2 FKMs are composed of VDF, HFP, and tetrafluoroethylene (TFE). Compared to copolymers, terpolymers have a higher fluorine content (typically between 68 and 69% fluorine by weight), resulting in greater chemical and heat tolerance. The compression range and versatility of low temperatures can be adversely affected.

Type 3 FKMs are composed of VDF, TFE, and perfluoromethylvinylether (PMVE). Compared to copolymers and terpolymers, the inclusion of PMVE offers increased low temperature stability. The fluorine content of Type 3 FKMs usually ranges from 62 to 68% by weight.

Type 4 FKMs are composed of propylene, TFE, and VDF. In type 4 FKMs, although base resistance is improved, their swelling properties are exacerbated, especially in hydrocarbons. They usually have a fluorine content of about 67% by weight.

Type 5 FKMs are composed of VDF, HFP, TFE, PMVE, and Ethylene. Type 5 FKM is known for its base resistance and hydrogen sulphide resistance at high temperatures.

The FKM that we are using has a fluorine content of about 70%.

As mentioned above, the chemical structure of FKM is mainly defined by the amount of fluorine content present.

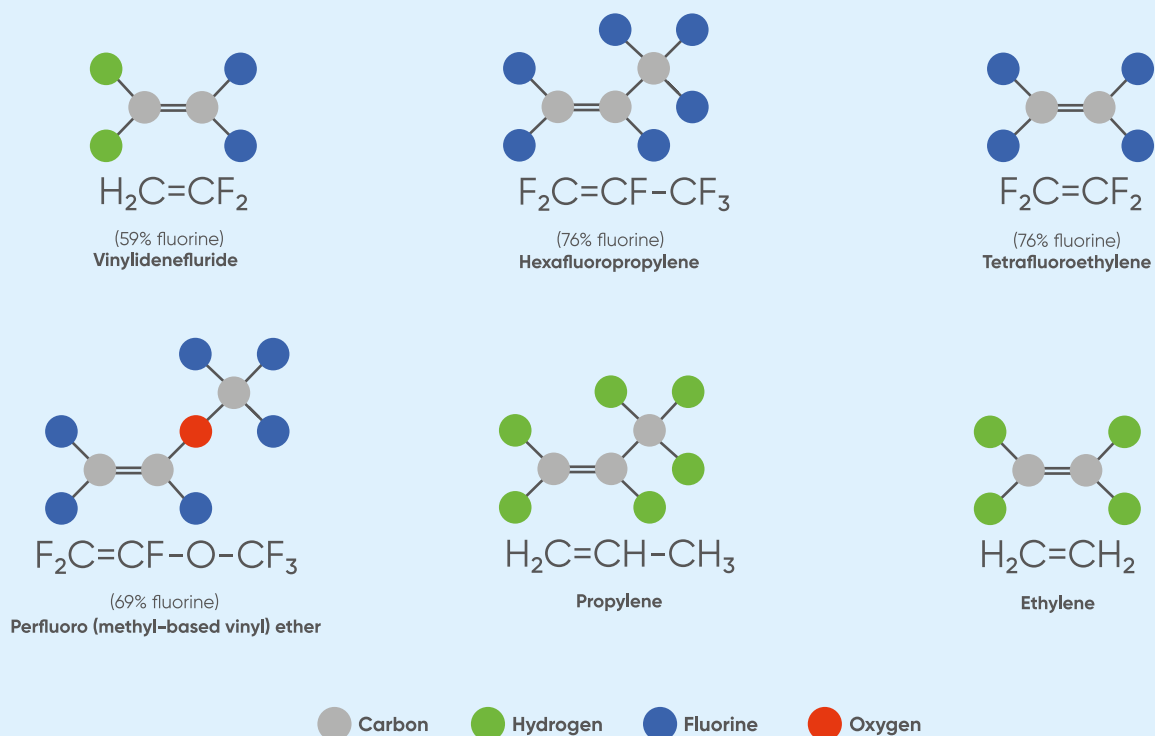

The picture is an example to show the chemical structure of different types of FKM.

Advantages of FKM

- The resilience of fluoroelastomers to chemical attacks by oxidation, acids and fuels is excellent.
- Their resistance to steam, methanol, and other highly polar fluids is minimal.
- The high ratio of fluorine to hydrogen, the strength of the carbon-fluorine bond, and the lack of unsaturation are the reasons for the exceptional heat stability and excellent oil resistance.
- As well as aromatic hydrocarbons, fuels, acids, and steam, they can endure heavy bases and ketones.
- Fluoroelastomers treated by peroxide have inherently greater resistance to water, steam, and acid.

Applications of FKM

Even in extreme conditions, FKM offers quality, long-term dependability. Below, a list of its applications is provided:

- valves sealing O-ring and diaphragm;
- flange and stub end gaskets;
- manifold gaskets;
- fuel tank bladders;
- firewall seals;
- engine lube siphon hose fuel system seals.

In Aliaxis, we are using a medium viscosity, high fluorine (70 %), peroxide curable fluoroelastomer. Our FKM exhibits superior resistance to a wide variety of chemicals, coupled with excellent processability and optimum compression set. FKM has a temperature range of -10°C to $+205^{\circ}/230^{\circ}\text{C}$, depending on the grade.

1.4.4 Perfluoroelastomer (FFKM)

Perfluoroelastomer (FFKM/FFPM) parts resist over 1.800 different chemicals, including concentrated nitric acid, sodium hydroxide, ethylene diamine and steam while offering the high temperature stability of PTFE (327°C).

In highly violent chemical processing, semiconductor wafer production, pharmacy, oil and gas recovery, and aerospace applications, FFKM components are used.

Long-term, proven performance of FFKM components can mean less frequent changes of seals, repairs and inspections, increasing uptime of processes and equipment for greater productivity and yield.

In Aliaxis, we are using FFKM product in case of our customer demand for specific severe process.

The performance of our FFKM are more consistent means that seal changes, repairs and inspections are required less frequently, and process and equipment uptime is extended, maximizing productivity and yield.

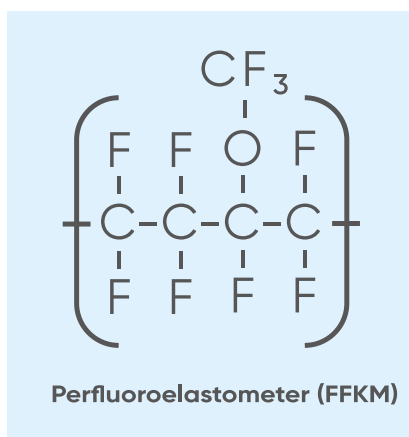

The picture shows the chemical structure of FFKM.

Advantages of FFKM

- Resistant to over 1,800 different chemicals.
- High temperature resistance up to 327°C.
- Maintains seal integrity.
- Reduced operating and maintenance costs.
- Long seal life.
- Meets safety standards of the pharmaceutical industry and food processing.
- Available in standard and special compounds for customized applications.

Applications of FFKM

- Seals and O-rings in valves, pumps, reactors and flanged joints.
- Valve Stem Packing Systems.
- High-performance parts for aerospace, oil and gas, transportation and chemical processing.

1.5 Polytetrafluoroethylene (PTFE)

Polytetrafluoroethylene (PTFE) is a fluorite polymer characterized by a high molecular weight a nearly full chemical resistance to reactivs and solvents.

PTFE is an inflammable material with an extremely high thermal stability, possesses high extraordinary strength and flexibility properties also at low temperatures.

Thanks to the self-lubricant and shock resistance characteristics, polytetrafluoroethylene polymers, under the trade names Teflon[®], Fluon[®], Argoflon[®] or other ones, have been successfully employed since many years in industrial applications for the manufacture of sealing components, bearings, locking rings and gears.

Among thermoplastic resins, PTFE allows reaching the highest working temperatures, since it can be commonly used at working temperatures of 250 °C to 260 °C.

On account of its extraordinary chemical inertia, PTFE polymers and copolymers are also largely employed as liners of pipelines, tanks and process equipments in the chemical industry.

PTFE consists of a series of carbon atoms bonded to each carbon by two fluorine atoms. The carbon chain is surrounded by these fluorine atoms, which produce a thick molecule with very tight carbon-fluorine bonds and a polymer structure that makes most chemicals inert with PTFE.

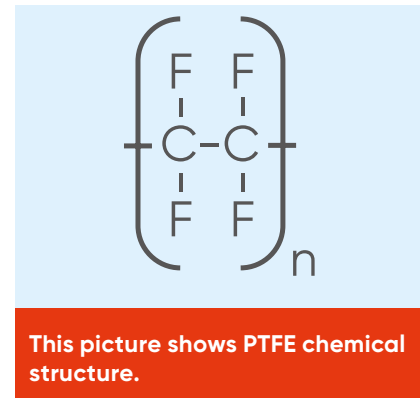

This picture shows PTFE chemical structure.

Properties of PTFE

- It is non-reactive, partially because of the strength of carbon-fluorine bonds, and so it is also used for reactive and corrosive chemicals in containers and pipework.
- If used as a lubricant, PTFE eliminates equipment friction, wear, and energy consumption. In surgical operations, it is widely used as a graft medium.
- PTFE is also used as a gasket material in industries that need resistance to aggressive chemicals, such as pharmaceuticals or chemical manufacturing, because of its superior chemical and thermal properties.
- PTFE possess an excellent electrical insulation property.
- It is non-adhesive and water-resistant material.
- Broad temperature resistance (-30 °C to +260 °C).
- It upholds the lowest coefficient of friction of any solid.

Applications of PTFE

Since PTFE is chemically inert material and its broad working temperature allowance makes it a good alternative in many industrial applications. The below are some of the application areas of PTFE:

- valves diaphragm or ball seats;
- industrial tape for threaded connections;
- chemical processing equipment components coating (pumps, valves, actuator);
- piping internal layer;
- gaskets.

1.6 Resins, Compounds and Additives

1.6.1 Resins

The term resin refers to any polymer that is the base material for a plastic, it is usually a mixture of organic compounds.

Resins are created by cracking process: in this operation heat is used to crack the hydrocarbons.

Obviously, temperature used during cracking process is largely responsible for the final amount and types of hydrocarbons.

After cracking has been finished, the different compounds created are formed into a chain called polymer. To create different chains and polymers is what allows to obtain plastics with different characteristics that can be used in different applications.



1.6.2 Compounds

Compound is a mixture of a thermoplastic polymer with other additives or ingredients.

For a polymer to be used to create what we know as the end plastic product it first needs to be compounded. The name compounding suggests that it is the combining of additives with a polymer to improve the polymer's properties.

The polymer is generally in a powder, bead or pellet form at the beginning of the compounding phase, although it may also be a solution, melt or suspension. The conversion of the melt into granules is the final stage of the process.

There are three stages to the development of a compound:

- mixing: bringing together the different ingredients;
- compounding: rough mixture of materials is mixed properly while favoured into a paste or melt;
- Granulation: the mixed material is shaped so that it can be cut into granules.

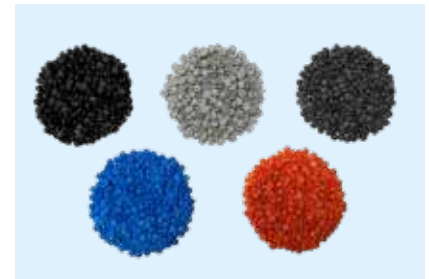

1.6.3 Additives

Without mixing additives into the polymer, a compound cannot be produced. To alter the properties of the material, an additive is required, making it stronger, more durable, cheaper or used to avoid polymer degradation.

There are two classes of additives that we can list: modifying additives and defensive additives.

As the name suggests modifying additives modify the physical properties of the polymer. Modifying additives include:

- plasticisers,
- fillers,
- extenders,
- chemicals (crosslinking agents, impact modifiers, blowing agents),
- pigments.

As the name suggests protective additives are used to protect the polymer from degradation. Protective additives include:

- antioxidants,
- heat stabilisers,
- UV stabilisers,
- lubricants (internal and external),
- processing aids.

1.7 Material test

In the life cycle of a polymer, from the raw material to the compound through to the semi-finished and finished component, testing plays a vital role. Testing helps to assess whether the material is sufficient in terms of its general material characteristics and thus allows us passing it to the next stage towards the end product. Quality is the outcome of both the process and the material. If there is a defect in the material that goes into the product, then the product may be defective. To ensure excellent quality in every product comes out of Aliaxis, we are carrying out different test methods. Below are the typical test methods that we are performing on raw material in our industrial product ranges.

1.7.1 Impact Test

Impact tests are used in studying the toughness of material. A material's toughness is a factor of its ability to absorb energy during plastic deformation. Brittle materials have low toughness as a result of the small amount of plastic deformation they can endure. The impact value of a material can also change with temperature. Generally, at lower temperatures, the impact energy of a material is decreased.

Test Types

There are basically two types of impact tests: pendulum and drop weight. The pendulum test method is suitable for impact testing of plastic materials, whereas drop weight is meant for steels.

Izod, Charpy, and tensile impact are the most common of the pendulum type tests.

Charpy, Izod and tensile impact testing are common methods for assessing a material's impact strength or toughness. In other words, the total amount of energy a material can absorb is determined by these experiments. This absorption of energy is closely related to the material's brittleness. Brittle materials tend to have poorer absorption rates than ductile materials.

It is important to consider the energy absorption properties of a material, as it forecasts how much plastic deformation the material can endure before catastrophic failure. The similarities and variations between these two popular impact test methods are also important to consider.

Pendulum type test methods

Izod Impact Testing

The test is named after Edwin Gilbert Izod (1876–1946), an English engineer, who described the test method in 1903. The Izod impact strength test is an ASTM standard method of determining the impact resistance of materials. A pivoting arm is raised (constant potential energy) to a certain height and then released. The arm swings down hitting a notched sample, breaking the specimen. The energy absorbed by the sample is calculated from the height the arm swings to after hitting the sample. To assess impact energy and notch sensitivity, a notched sample is usually used.

The configuration of the test equipment and specimen is very similar to the Charpy impact, with some noticeable variations, including the orientation of the specimen, clamped vertically into the equipment with the notch faced towards the pendulum. At a specified area above the notch, the pendulum then impacts the sample.

One of the key distinctions in the Charpy impact is that Izod impact testing can be carried out on either plastic or metal samples.

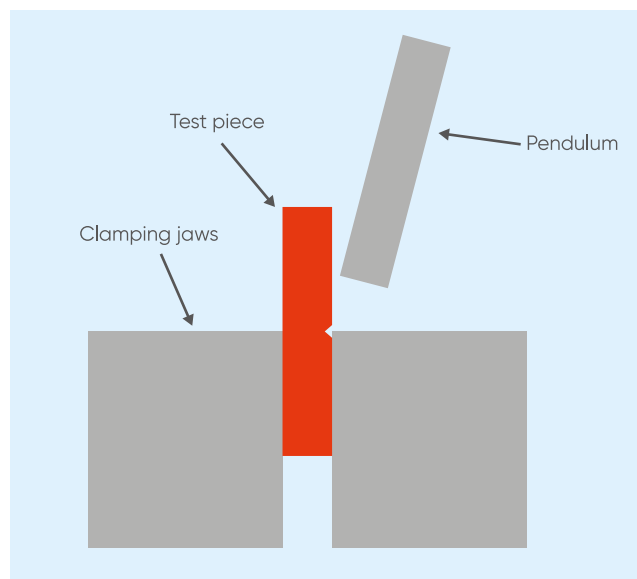

Charpy Impact Testing

The Charpy impact test was developed by S.B. Russell and Georges Charpy at the turn of the 20th century. Owing to the technological contributions and standardization efforts by Charpy, the test became known as the Charpy test in the early 1900s. Due to the relative simplicity of producing samples and acquiring results, it remains one of the most popular impact testing strategies to this day. The test apparatus consists of a weighted pendulum, which is dropped from a specified height to make contact with the specimen.

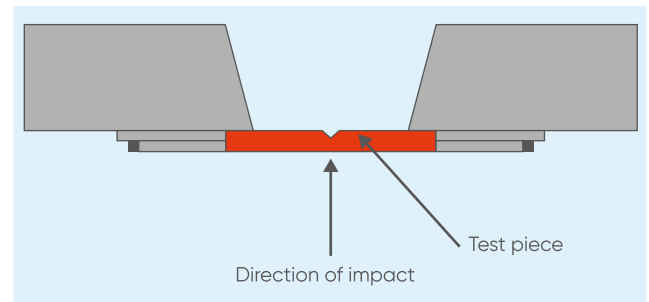

By measuring the difference in the height of the pendulum before and after the fracture, the energy transmitted to the substance can be calculated.

A Charpy test specimen, which is mounted horizontally into the machine, with a notch machined into one of the faces. This notch, which can be either V-shaped or U-shaped, is positioned facing away from the pendulum and helps to concentrate the stress and facilitate fracture. At both ambient and reduced temperatures, testing can be performed.

Charpy impact testing is most commonly performed on metals. For plastics and polymers, a range of test standards is applied, including ASTM D6110 and ISO 179.

Tensile impact testing

One of the most simple and common types of mechanical testing is a tensile impact test. A tensile test applies tensile force to a material and measures the specimen's response to the applied stress. By doing this, we can determine how strong a material is and how much it can elongate. Typically, tensile tests are performed on electromechanical or universal test machines (UTM).

We can obtain a complete profile of its tensile properties by testing the material as it is being pulled. This data resulted in a stress / strain curve when plotted on a graph, which indicates how the material responded to the forces that were applied. There is indeed a great deal of interest in the phase of fracture or failure, but other significant characteristics include the modulus of elasticity, yield strength, and strain.

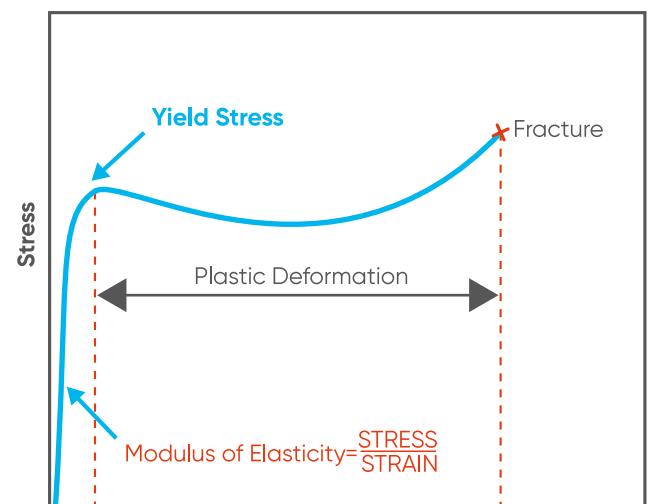

Below there are the most important terms associated with tensile impact test.

Ultimate Tensile Strength

One of the most important properties we can determine about a material is its ultimate tensile strength (UTS). This is the maximum stress that a specimen sustains during the test.

Hooke's Law

Hooke's Law demonstrates a linear relationship between the applied force or load and the elongation exhibited by the specimen. In other words, Hooke's law is a law where the ratio of stress to strain is a constant, $E = \sigma/\epsilon$. Where, E is the "Modulus of Elasticity" or "Young's Modulus", σ is the applied stress/load, ϵ is the strain observed on the material for the applied load.

Modulus of Elasticity

The modulus of elasticity is a measure of the stiffness of the material that only appears in the curve's initial linear region. This region is so-called «Elastic Region», which means that within this region the material will regain its original shape after the removal of the applied load.

The table shows the modulus of elasticity values of different plastics in compliance with ISO 527-1.

Material	Value (MPa, 23°C)
UPVC	2,700
CPVC	2,700
ABS	2,000
PP-H	1,300
PE100	1,000
PVDF	1,900

Yield Stress (Yield Strength)

A material's «yield strength» is defined as the stress applied to the material at which it begins to deform plastically (permanently). This region in which this behaviour appears called as «Plastic Deformation Region», which means that after reaching this region the material will lose its ability to regain its original shape even after the removal of the applied load.

The table shows the yield strength values of different plastics in compliance with ISO 527-1.

Material	Value (MPa, 23°C)
UPVC	54
CPVC	53
ABS	40
PP-H	33
PE100	23
PVDF	50

1.7.2 Melt flow test

A melt flow measurement tests a molten polymer's melt flow rate (MFR) and melt volume rate (MVR). At a certain temperature and with a certain mass added, values are taken based on the material.

The melt flow test specimen is made up of:

- a hot barrel at one end with a removable die;
- temperature control of the barrel;
- a piston that should fit in the barrel.

Melt flow rate (MFR)

Rate of extrusion of a molten resin through a die of specified length and diameter under prescribed conditions of temperature, load and piston position in the cylinder of an extrusion plastometer, the rate being determined as the mass extruded over a specified time. MFR is expressed in units of grams per 10 min (g/10 min)

Melt volume rate (MVR)

Rate of extrusion of a molten resin through a die of specified length and diameter under prescribed conditions of temperature, load and piston position in the cylinder of an extrusion plastometer, the rate being determined as the volume extruded over a specified time. MVR is expressed in units of cubic centimetres per 10 min (cm³/10 min).



1.7.3 Thermal Test

Thermal testing is mainly carried out to determine two important material properties of the plastics such as Heat Deflection Temperature (HDT) and VICAT softening point temperature.

Heat Deflection Temperature (HDT)

The heat deflection temperature or heat distortion temperature (HDT) is the temperature at which a polymer or plastic specimen deflects under flexural load. This property of a given plastic material is applied in many aspects of product design, engineering and manufacture of products using thermoplastic components.

The heat distortion temperature is determined by the following test procedure outlined in ISO 75-2 (ASTM D648). The test specimen is loaded in three-point bending in the edgewise direction. The outer fibre stress used for testing is either 0.45 MPa or 1.80 MPa, and the temperature is increased at 2 °C/min until the specimen deflects 0.25 mm.

The table below shows the Heat Deflection Temperature (HDT) values of different plastics in compliance with ISO 75-2 (ASTM D648).

The values followed by the letter B refer to 0.45 MPa, while those followed by the letter A to 1.8 MPa.

Material	Value (°C)	Max. Piping System Operating Temperature (°C)
UPVC	74 (A)	60
CPVC	103 (A)	95
ABS	78 (A)	60
PP-H	95-105 (B)	95
PE100	75 (B)	60
PVDF	110 (A), 145 (B)	140

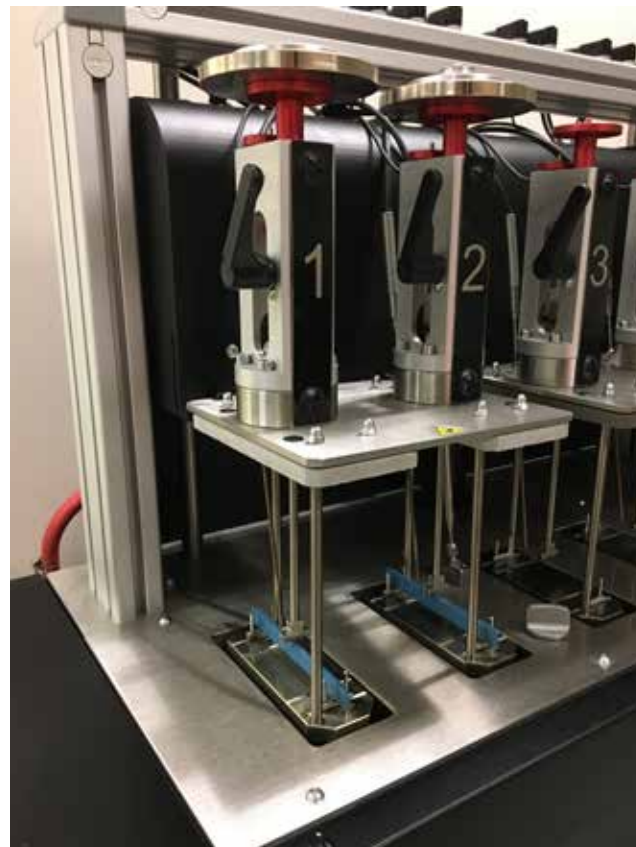
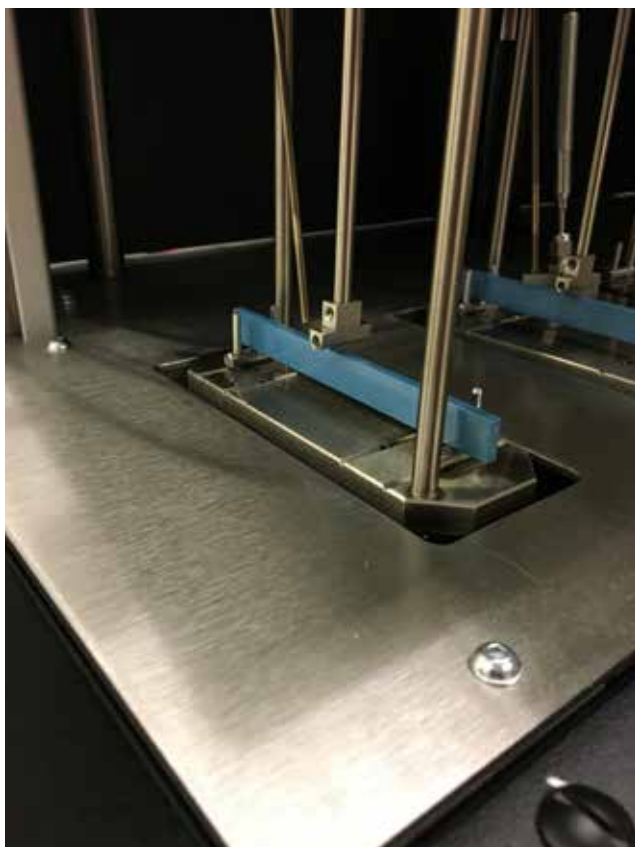

VICAT softening point temperature

Vicat softening temperature or Vicat hardness is the determination of the softening point for materials that have no definite melting point, such as plastics. It is taken as the temperature at which the specimen is penetrated to a depth of 1 mm by a flat-ended needle with a 1 mm² circular or square cross-section.

Standards to determine Vicat softening point include ISO 306 and ASTM D 1525.

1.8 Pipe and fittings marking

Every component undergoes marking before the part is being delivered to the customer. Marking is carried out for a better understanding of important details of the part in a simpler way possible. Generally, while marking the important pieces of information such as material type, name of the manufacturer, pressure rating, size, standard, and manufacturing date are printed.

Marking elements shall be printed or formulated directly on the component, or printed on a label, in such a way that readability is not affected by storage, weathering, handling or installation.

NOTE: The manufacturer is not liable for the labelling on a component becoming illegible due to actions caused during installation and use such as painting, scratching or covering over, or the use of detergents, etc., unless agreed with or specified by the manufacturer.

Marking shall not lead to cracks or other types of defects which adversely affect the component's performance.

Where printing is used, the colour of the printed information is distinct from that of the component's base colour. The size of the marking must be such that, without magnification, the marking is legible.

Difference between marking and labelling

On one hand, the marking is formed or printed directly on the component, on the other hand, the labelling is carried out by separately printing the label and then the printed label will be glued or pasted on the component.

1.8.1 Minimum requirements in marking of pipes

The pipes must be marked at intervals of no more than 1 m, at least once per pipe. As an example, the table below presents the minimum required marking of the pipes manufactured according to ISO 15493.

Information	Marking or symbol
Number of this International Standard	ISO 15493
Manufacturer's name and/or trademark	Name or symbol
Nominal outside diameter	e.g. 110
Nominal wall thickness	e.g. 5.3
Pipe series S or standard dimension ratio SDR	e.g. S 10 or SDR 21
Nominal pressure PN	e.g. PN 10
Material	e.g. PVC-U
Manufacturer's information	^a

^a To provide traceability, the following details shall be given:

- the production period (year and month), in figures or in code form;
- a name or code for the production site if the manufacturer is producing at different sites.



This picture shows how the marking will look like on a UPVC pipe material and what information will be present on it. Generally, the marking on a pipe material is in accordance with the standard EN ISO 12201.

1.8.2 Minimum requirements in marking of fittings

The table below presents the minimum requirements in marking of the fittings manufactured according to ISO 15493.

Information	Marking or symbol
Number of this International Standard ^a	ISO 15493
Manufacturer's name and/or trade mark	Name or symbol
Nominal outside diameter(s)	e.g. 63-32-63
Nominal wall thickness	e.g. 5,8
Pipe series S or standard dimension ratio SDR	e.g. S 10 or SDR 21
Nominal pressure PN	e.g. PN 10
Nominal size DN ^b	e.g. DN 50
Material	e.g. PVC-U
Manufacturer's information	^c

^a This information shall be marked at least on the packaging.

^b Applicable to flanges only.

^c For fittings with dn > 32 mm, the following details shall be given to provide traceability:

- the production period (year and month), in figures or in code form;
- a name or code for the production site if the manufacturer is producing at different sites.



This picture shows marking on a UPVC fitting.

1.8.3 Minimum requirements in marking of valve

Valves shall be marked in accordance with the requirements of ISO 16135, ISO 16136, ISO 16137, ISO 16138, ISO 16139 or ISO 21787, as applicable, depending on the valve type.

1.9 MRS and Long-Term Behaviour

The practical service life of a pipe that is exposed to internal pressure is one of the most significant aspects of plastic pipes. This attribute is referred to as long-term behaviour. The temperature and flow medium play an important role when evaluating long-term behaviour.

In Europe, the long-term hydrostatic strength of plastic piping materials, known as the Minimum Required Strength (MRS), is used to determine the pressure rating of plastic piping.

The MRS value is determined by analysing long term pipe tests in accordance with the following standards:

- EN ISO 15493 (UPVC, CPVC, and ABS).
- EN ISO 15494 (PE, PP).
- EN ISO 10931 (PVDF).

MRS values (Minimum Required Strength) for thermoplastic materials used in the construction of industrial piping systems are shown in the following table.

Material	MRS Value (MPa) Water, 20°C, 50 years
UPVC	25
CPVC (pipe)	25
CPVC (fitting)	20
ABS	14
PP-H	10
PE100	10
PE80	8
PVDF	25

1.9.1 Terms associated with long-term behaviour

Creep: All thermoplastic materials exhibit the property known as creep, i.e. over a period it undergoes deformation, even at room temperature and under relatively low stress. After the stress is being removed, a material regains its original shape, based on the time under stress and stress severity.

The deformation in which the material could regain its original shape is called elastic deformation and in contrast, where the material loses its property to get back to its original shape is known as plastic deformation.

Long-term material test: The mechanical property values of the plastic material, which in most cases depends on the following three parameters.

- Time.
- Temperature.
- Stress.

The mechanical properties of a material, at a certain temperature for over a long period, can be determined by long-term material test. The long-term material test is a test in which the material's failure behaviour can be calculated by simulating with pressure and temperature for a longer test time specified by ISO 1167 for different materials.

97.5 % Lower Predictable Limit (LPL): Which means that, at least 97.5 % of the data points shall be on or above the reference curves of the respective materials.

1.9.2 Long-term behaviour of UPVC

The long-term behaviour of UPVC can be seen from the following hoop stress diagram. Fracture lines are shown for temperatures ranging from +20 °C to +60 °C. These are referred to as Lower Predictable Limit (LPL) curves, which means that 97.5 % of all fracture points are on or above the corresponding curve as described.

By using the Standard Extrapolation Method (SCM) according to EN ISO 9080, the long-term behaviour was calculated. The formula below helps us to determine various parameters like stress, temperature or time to failure for the temperature range of +20 °C to +60 °C.

Formula:

$$\log t = -164.461 - 29349.493 \times \frac{\log \sigma}{T} + 60126.534 \times \frac{1}{T} + 75.079 \times \log \sigma$$

where:

t_f = time to failure (in hours),

T = temperature of the flowing medium (in °C),

σ = Hoop stress (in MPa) (1 MPa = 1 N/mm²).

Minimum required hydrostatic strength curves for UPVC.

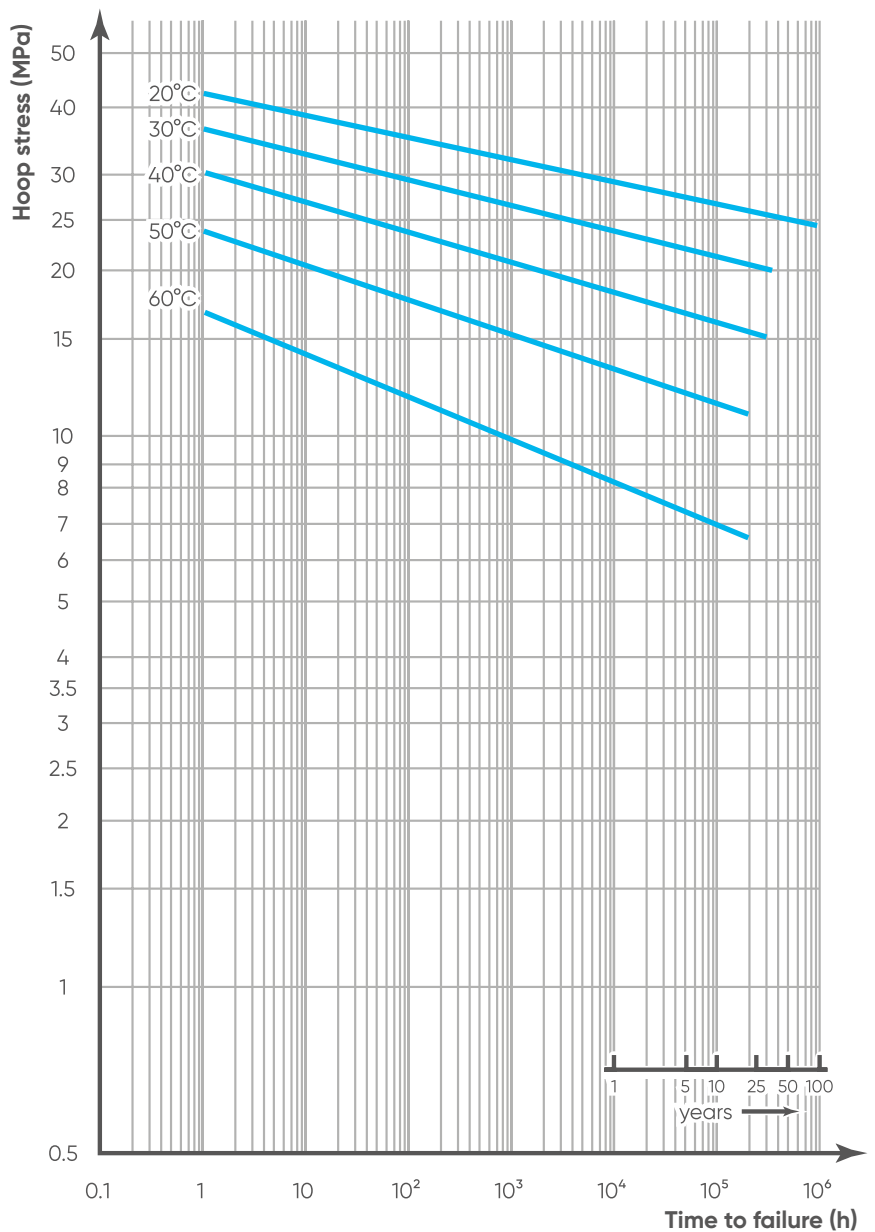

Practical example on how to read the MRS graph:

1) What is the MRS value of UPVC pipe conveying water at 20°C for 50 years of lifetime?

By looking at hydrostatic strength curve for UPVC, at 20°C and 50 years of service life, MRS value is 25 MPa, as shown graphically in the following picture.

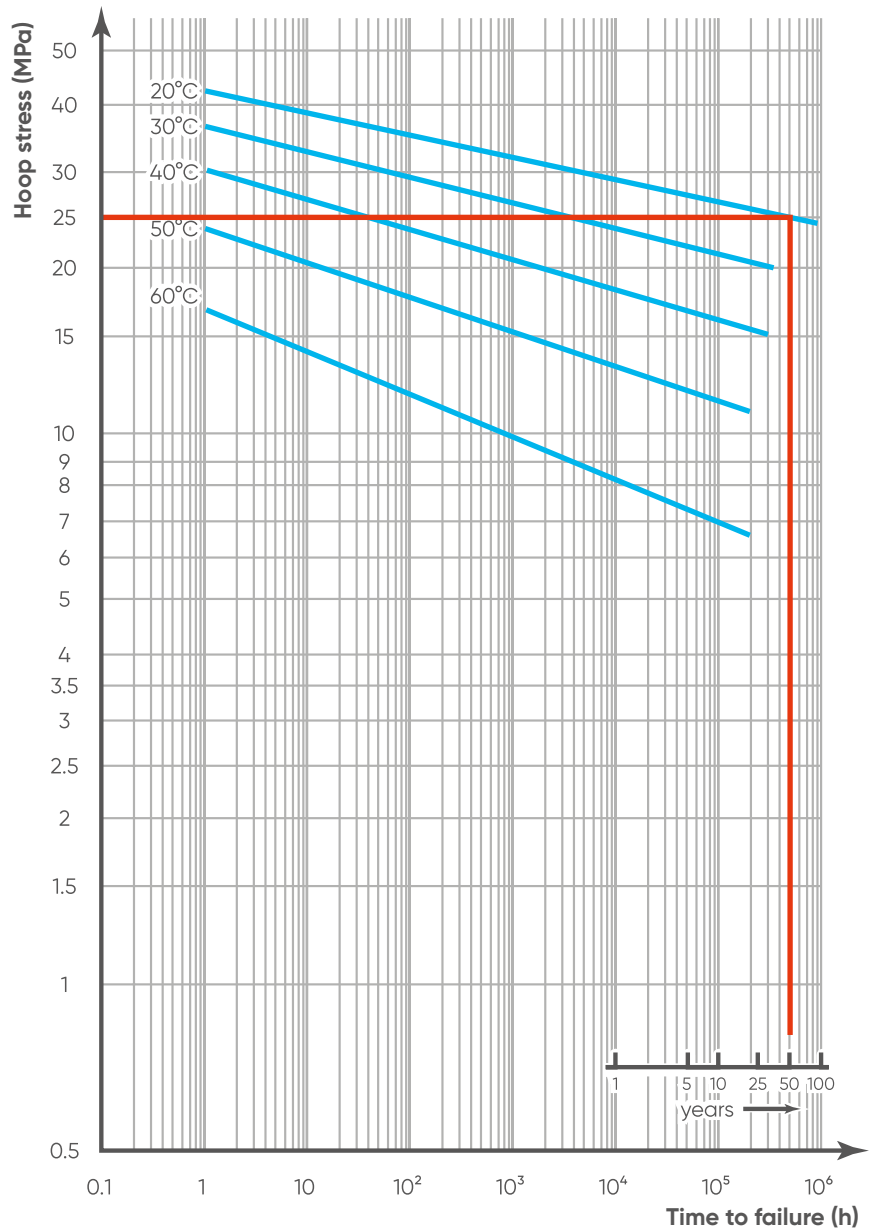

Minimum required hydrostatic strength curves for UPVC.

1.9.3 Long-term behaviour of CPVC

The long-term behaviour of CPVC can be seen from the following hoop stress diagram. Fracture lines are shown for temperatures ranging from +10 °C to +95 °C and +10 °C to +90 °C for pipe and fittings material respectively. These are referred to as Lower Predictable Limit (LPL) curves, which means that 97.5 % of all fracture points are on or above the corresponding curve as described.

By using the Standard Extrapolation Method (SCM) according to EN ISO 9080, the long-term behaviour was calculated. The formula below helps us to determine various parameters like stress, temperature or time to failure for pipe and fitting materials in the temperature range of +10 °C to +95 °C and +10 °C to +90 °C respectively.

Formula applicable for a pipe made of CPVC (10 °C to 95 °C)

$$\log t = -109.95 - 21897.4 \times \frac{\log \sigma}{T} + 43702.87 \times \frac{1}{T} + 50.74202 \times \log \sigma$$

where:

t_f = time to failure (in hours),

T = temperature of the flowing medium (in °C),

σ = Hoop stress (in MPa) (1 MPa = 1 N/mm²).

Minimum required hydrostatic strength curves for CPVC pipe material.

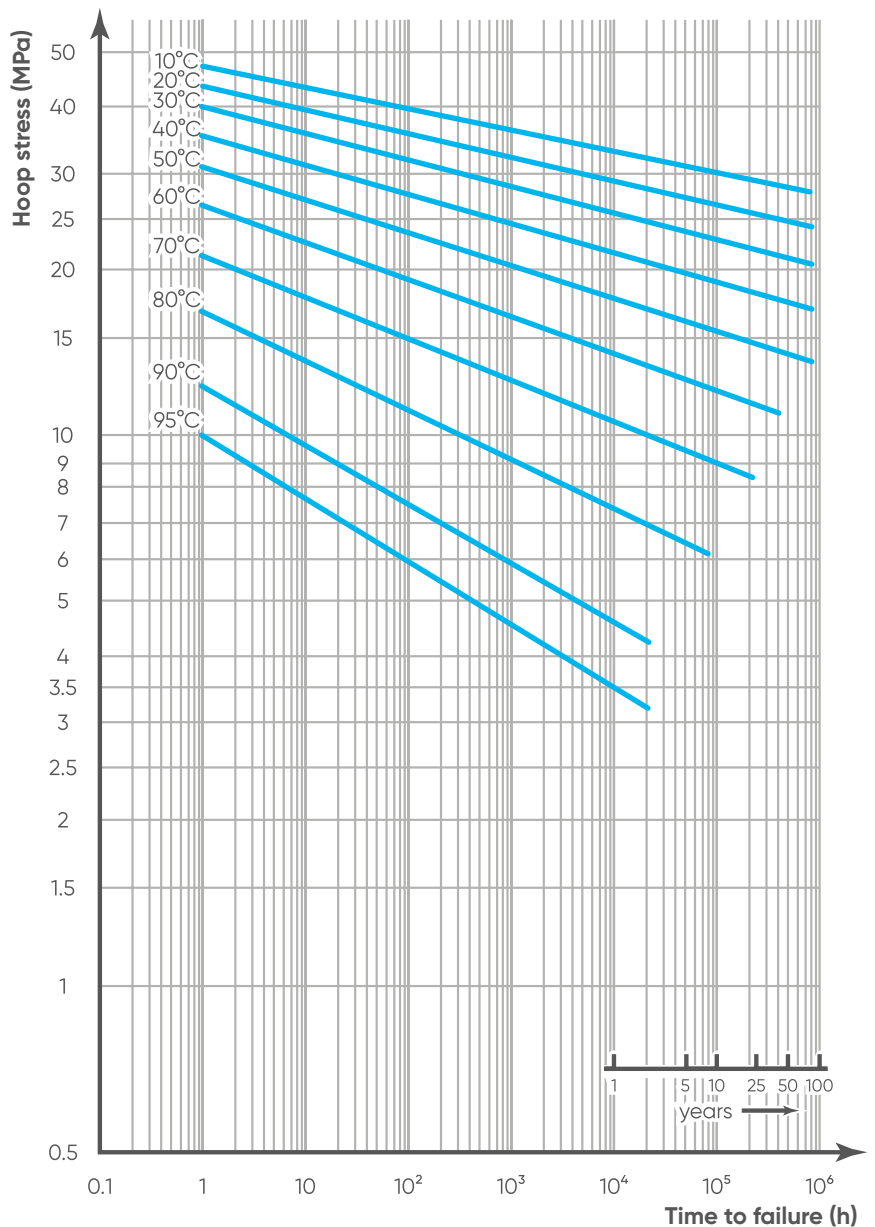

Formula applicable for a fitting made of CPVC (10 °C to 95 °C)

$$\log t = -121.699 - 25985 \times \frac{\log \sigma}{T} + 47143.18 \times \frac{1}{T} + 63.03511 \times \log \sigma$$

where:

t_f = time to failure (in hours),

T = temperature of the flowing medium (in °C),

σ = Hoop stress (in MPa) (1 MPa = 1 N/mm²).

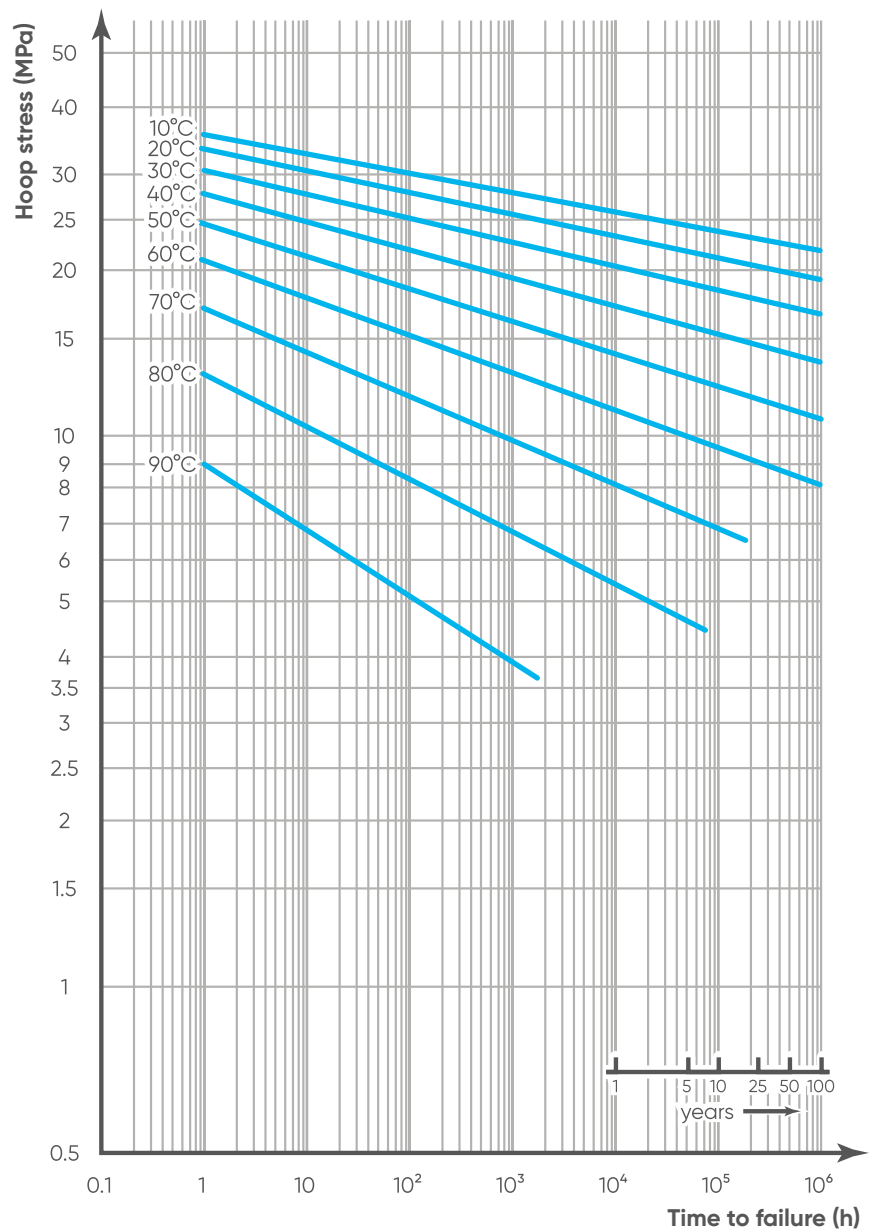

Minimum required hydrostatic strength curves for CPVC fitting material.

1.9.4 Long-term behaviour of ABS

The long-term behaviour of ABS can be seen from the following hoop stress diagram. Fracture lines are shown for temperatures ranging from +10 °C to +60 °C. These are referred to as Lower Predictable Limit (LPL) curves, which means that 97.5 % of all fracture points are on or above the corresponding curve as described.

By using the Standard Extrapolation Method (SCM) according to EN ISO 9080, the long-term behaviour was calculated. The formula below helps us to determine various parameters like stress, temperature or time to failure for the temperature range of +10 °C to +60 °C.

Formula:

$$\log t = -154.8961 - 35935.57 \times \frac{\log \sigma}{T} + 55180.34 \times \frac{1}{T} + 98.73749 \times \log \sigma$$

where:

t_f = time to failure (in hours),

T = temperature of the flowing medium (in °C),

σ = Hoop stress (in MPa) (1 MPa = 1 N/mm²).

Minimum required hydrostatic strength curves for ABS.

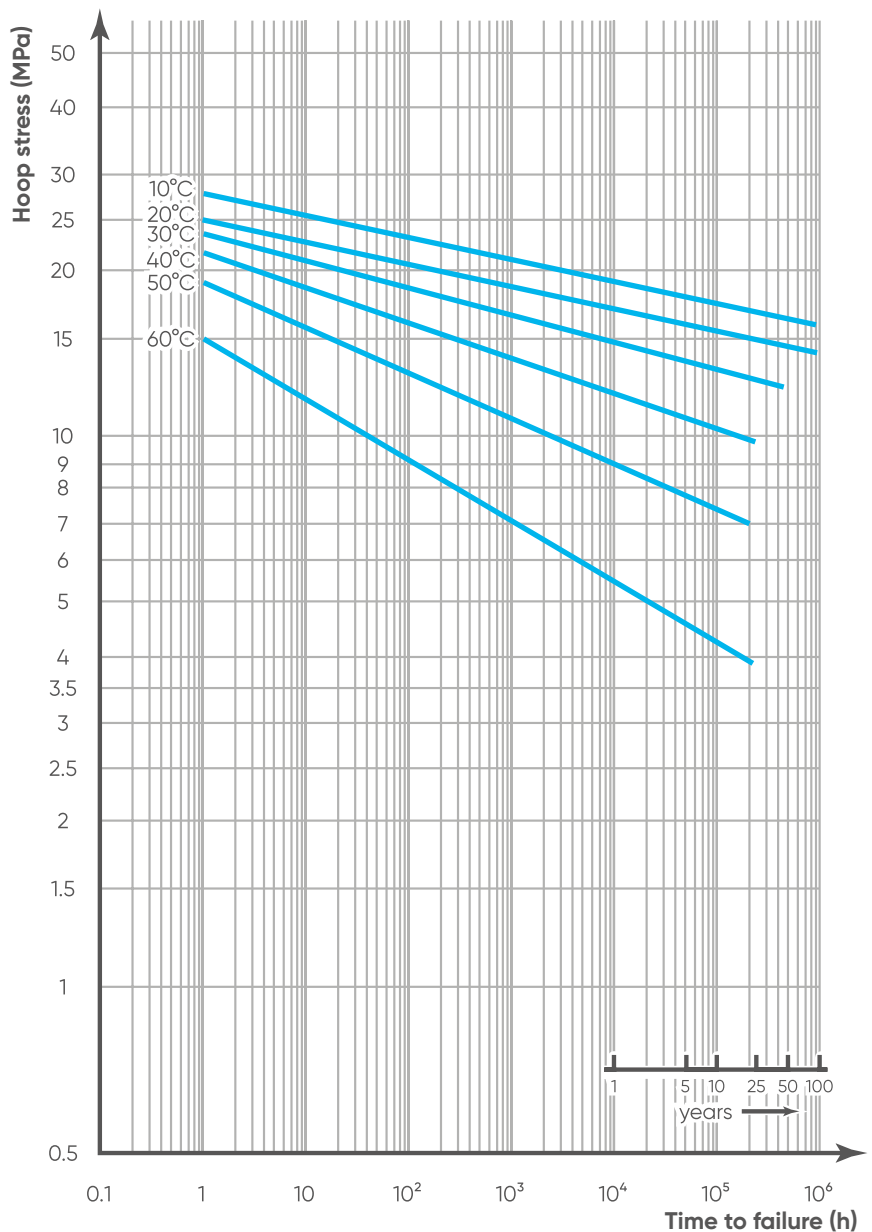

1.9.5 Long-term behaviour of PP-H, PP-B, and PP-R

The long-term behaviour of PP-H, PP-B and PP-R can be seen from the following hoop stress diagram. Fracture lines are shown for temperatures ranging from +10 °C to +110 °C. These are referred to as Lower Predictable Limit (LPL) curves, which means that 97.5 % of all fracture points are on or above the corresponding curve as described. By using the Standard Extrapolation Method (SCM) according to EN ISO 9080, the long-term behaviour was calculated. The formula below helps us to determine various parameters like stress, temperature or time to failure for the temperature range of +10 °C to +80 °C. If measurements with longer measurement periods are carried out at 85 °C, 90 °C, 95 °C and 110 °C, as appropriate, the dotted lines of the reference curves apply. The longer testing period shall be deduced from the extrapolation time limits specified in ISO 9080.

Note: By using water inside and air outside, the 110 °C curve being measured separately; it cannot be determined using the formulas below.

PP-H Formula:

First Branch: (applicable for the temperature range +10 °C to +80 °C)

$$\log t = -46.364 - 9601.1 \times \frac{\log \sigma}{T} + 20381.5 \times \frac{1}{T} + 15.24 \times \log \sigma$$

Second Branch: (applicable for the temperature range from +80 °C to +110 °C)

$$\log t = -18.387 - 8918.5 \times \frac{1}{T} - 4.1 \times \log \sigma$$

where:

t_f = time to failure (in hours),

T = temperature of the flowing medium (in °C),

σ = Hoop stress (in MPa) (1 MPa = 1 N/mm²).

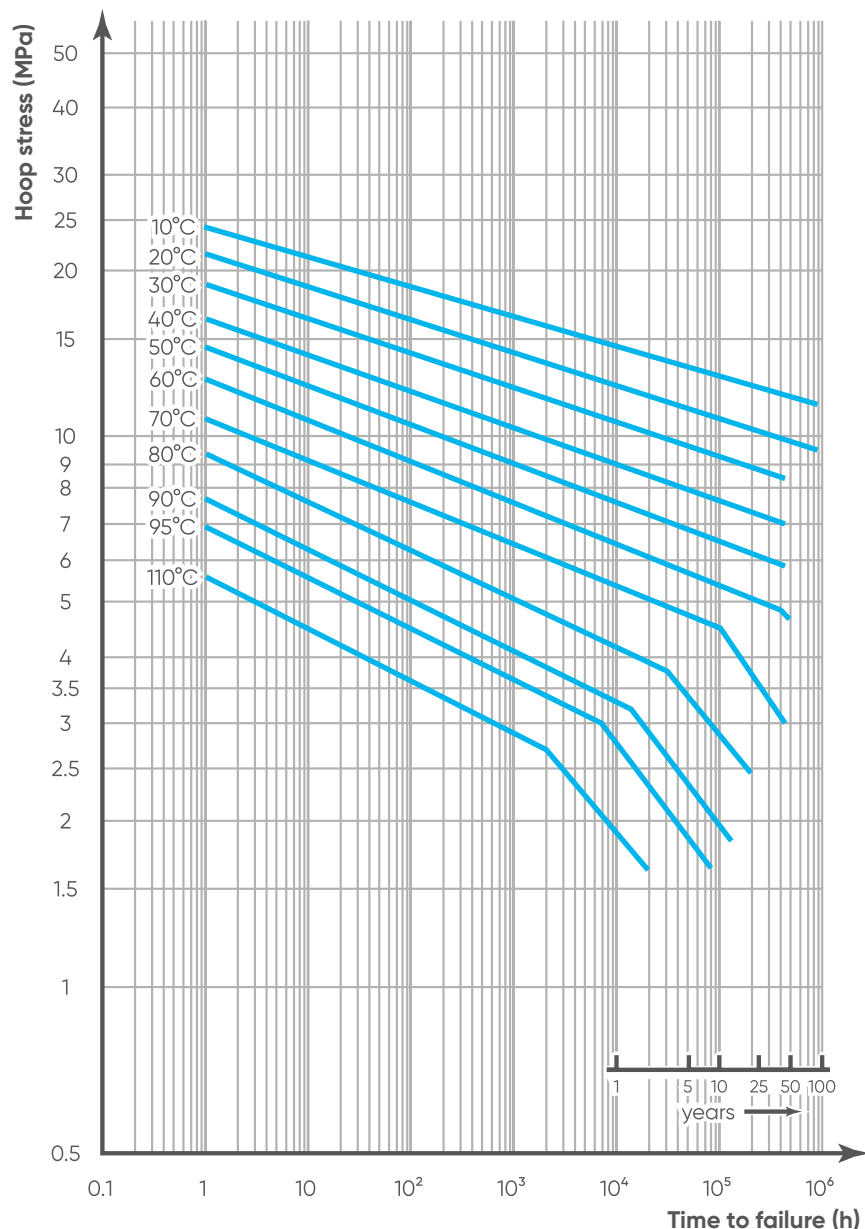

Minimum required hydrostatic strength curves for PP-H.

PP-B Formula:

First Branch: (applicable for the temperature range +10 °C to +80 °C)

$$\log t = - 56.086 - 10157.8 \times \frac{\log \sigma}{T} + 23971.7 \times \frac{1}{T} + 13.32 \times \log \sigma$$

Second Branch: (applicable for the temperature range from +80 °C to +110 °C)

$$\log t = - 13.699 - 6970.3 \times \frac{1}{T} - 3.82 \times \log \sigma$$

where:

t_f = time to failure (in hours),

T = temperature of the flowing medium (in °C),

σ = Hoop stress (in MPa) (1 MPa = 1 N/mm²).

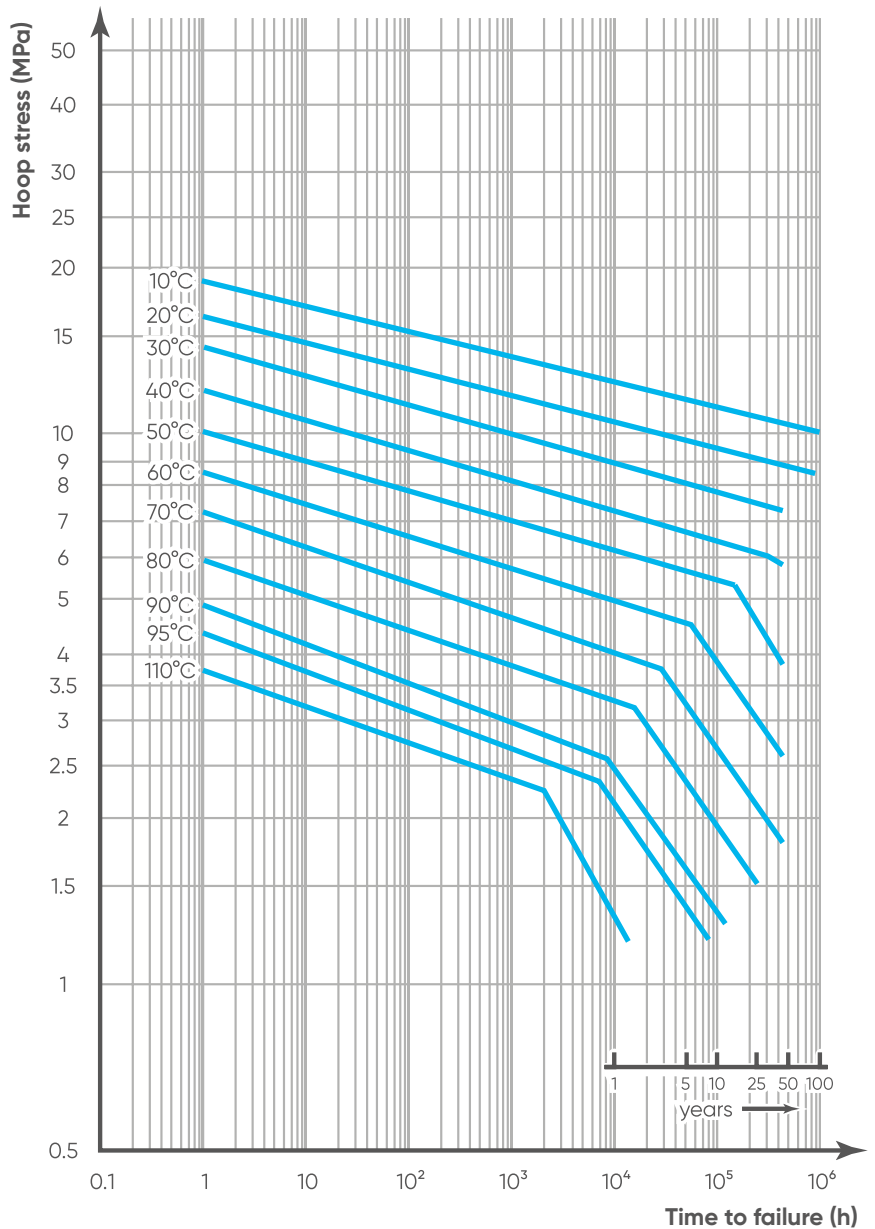

Minimum required hydrostatic strength curves for PP-B.

PP-R Formula:

First Branch: (applicable for the temperature range +10 °C to +80 °C)

$$\log t = - 55.725 - 9484.1 \times \frac{\log \sigma}{T} + 22502.2 \times \frac{1}{T} + 6.39 \times \log \sigma$$

Second Branch: (applicable for the temperature range from +80 °C to +110 °C)

$$\log t = - 19.98 + 9507 \times \frac{1}{T} - 4.11 \times \log \sigma$$

where:

t_f = time to failure (in hours),

T = temperature of the flowing medium (in °C),

σ = Hoop stress (in MPa) (1 MPa = 1 N/mm²).

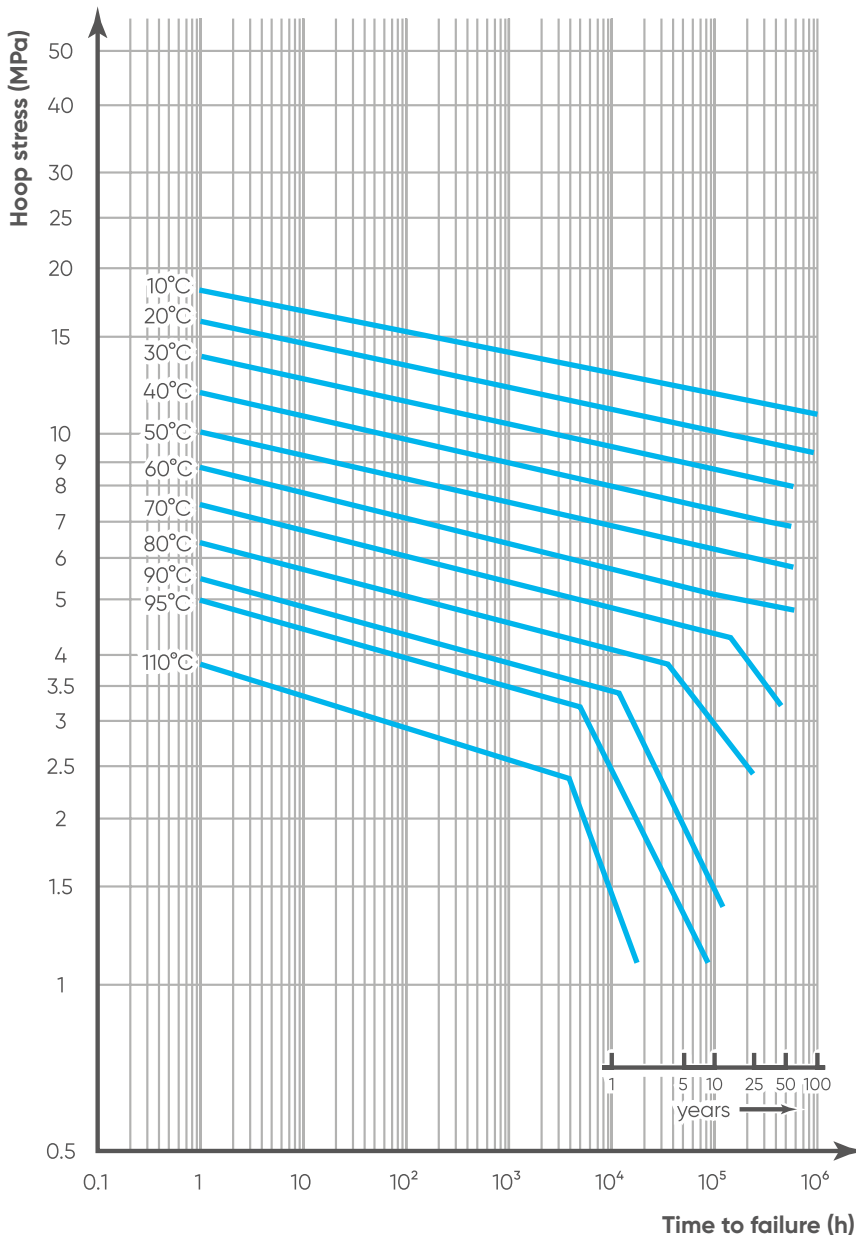

Minimum required hydrostatic strength curves for PP-R.

1.9.6 Long-term behaviour of PE

The long-term behaviour of PE-100 and PE-80 can be seen from the following hoop stress diagram. Fracture lines are shown for temperatures ranging from +10 °C to +80 °C. These are referred to as Lower Predictable Limit (LPL) curves, which means that 97.5 % of all fracture points are on or above the corresponding curve as described.

By using the Standard Extrapolation Method (SCM) according to EN ISO 9080, the long-term behaviour was calculated. The formula below helps us to determine various parameters like stress, temperature or time to failure and to plot the graph to demonstrate the long-term behaviour of PE-100 and PE-80 for the temperature range +10 °C to +80 °C. However, 80°C is applicable only on short time application.

Formula PE-80

$$\log t = - 42.5488 + 24074.8254 \times \frac{1}{T} - 37.5758 \times \log \sigma$$

where:

t_f = time to failure (in hours),

T = temperature of the flowing medium (in °C),

σ = Hoop stress (in MPa) (1 MPa = 1 N/mm²).

Minimum required hydrostatic strength curves for PE 80.

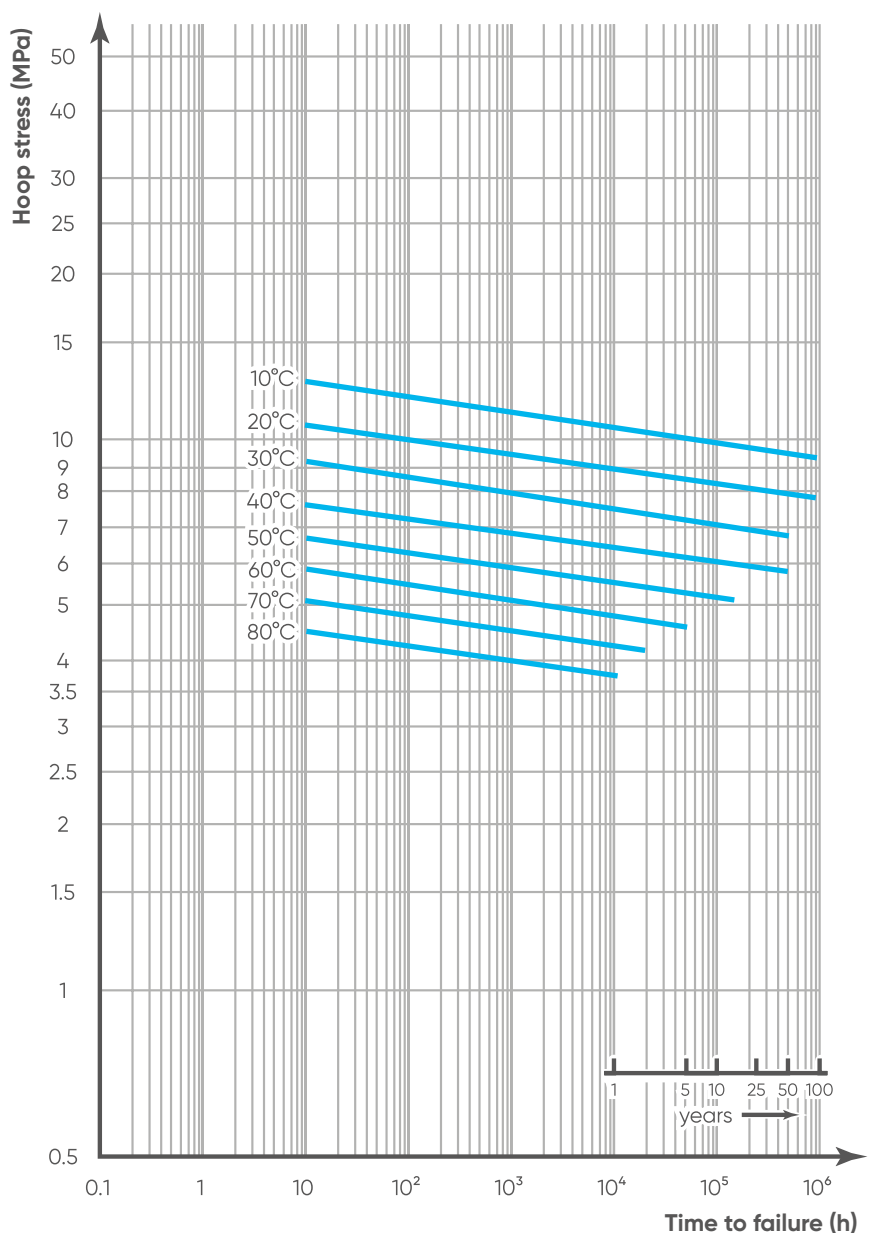

Formula PE-100

$$\log t = -45.4008 + \frac{28444.7345}{T} - 45.9891 \times \log \sigma$$

where:

t_f = time to failure (in hours),

T = temperature of the flowing medium (in °C),

σ = Hoop stress (in MPa) (1 MPa = 1 N/mm²).

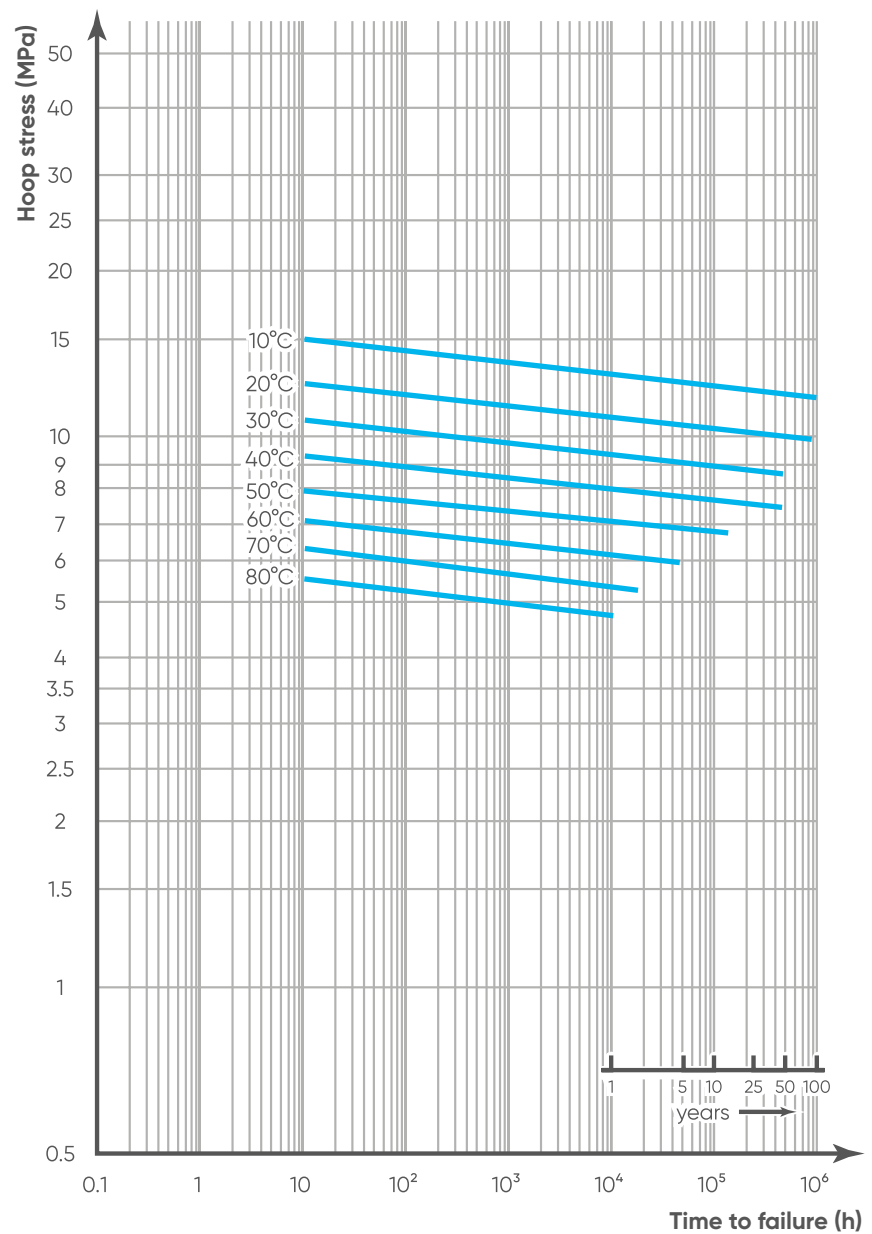

Minimum required hydrostatic strength curves for PE 100.

1.9.7 Long-term behaviour of PVDF

The long-term behaviour of PVDF can be seen from the following hoop stress diagram. Fracture lines are shown for temperatures ranging from +20 °C to +140 °C. These are referred to as Lower Predictable Limit (LPL) curves, which means that 97.5 % of all fracture points are on or above the corresponding curve as described.

By using the Standard Extrapolation Method (SCM) according to EN ISO 9080, the long-term behaviour was calculated. The formula below helps us to determine various parameters like stress, temperature or time to failure and to plot the graph to demonstrate the long-term behaviour of PVDF for the temperature range +20 °C to +140 °C.

Formula:

First Branch: (applicable for the temperature range +20 °C to +90 °C)

$$\log t = - 165.4958 - 36518.7 \times \frac{\log \sigma}{T} + 78465.65 \times \frac{1}{T} + 57.0467 \times \log \sigma$$

Second Branch: (applicable for the temperature range +95 °C to +140 °C)

$$\log t = - 23.19426 - 1611.69 \times \frac{\log \sigma}{T} + 12100 \times \frac{1}{T} - 0.40473 \times \log \sigma$$

where, t_f = time to failure (in hours),

T = temperature of the flowing medium (in °C),

σ = Hoop stress (in MPa) (1 MPa = 1 N/mm²).

Minimum required hydrostatic strength curves for PVDF.

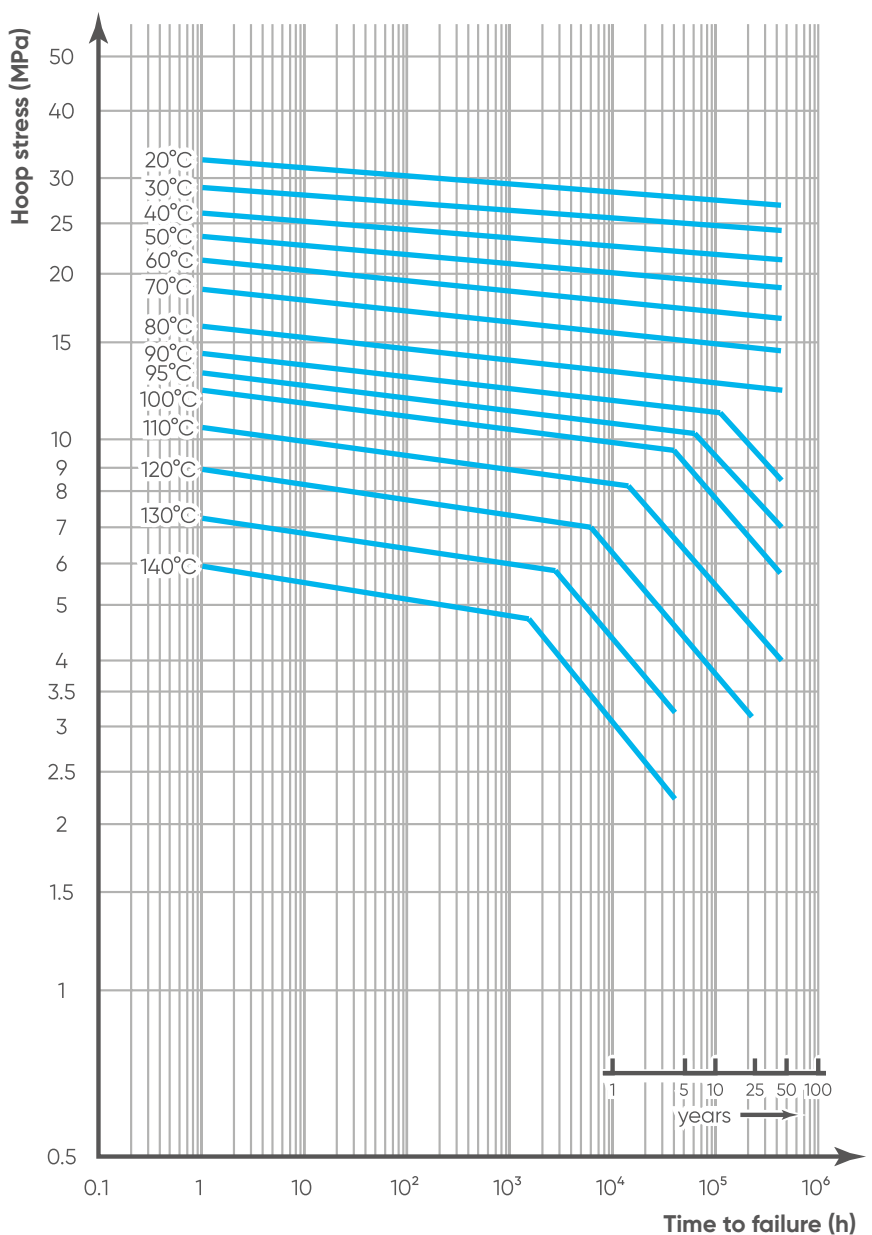

1.9.8 Service life in case of intermitted load

In the case of applications in which alternating loads regularly occur, the theory of linear accumulation of damage, also called Miner's rule, can be used to determine approximate operating times for applications with varying conditions during their expected service life.

According to DVS 2205, the expected service life (t_m) is determined by adding together the damage rates for the intermittent operating conditions.

According to this rule the following applies to the mechanical load:

$$\sum \frac{(a_i * t_m)}{(100 * t_i)} = 1$$

For two loads the following therefore applies:

$$t_m = \frac{(100 * t_{m1} * t_{m2})}{(a_1 * t_{m2} + 2 * t_{m1})}$$

Since the permissible service life of components is not only dependent on mechanical load but also on heat aging, the influence of aging (t_a) must be determined by this equation:

$$\sum \frac{(a_i * t_a)}{(100 * t_i)} = 1$$

where:

i = number of partial loads

a_1, a_2, \dots, a_n = proportion of partial load times that make up the total load time in percentage

$t_{m1}, t_{m2}, \dots, t_{mn}$ = service life under the individual operating conditions

$t_{a1}, t_{a2}, \dots, t_{an}$ = aging times at the relevant temperatures

t_m = calculates service life under mechanical load

t_a = calculated service life under the influence of aging

PRACTICAL EXAMPLE

In the following table are described the operating conditions and damage proportions for PPH:

Partial stresses	Stresses	Temperature	Time proportion (a)	Computational service life with partial stresses (t_m)	Damage proportion %
1	6 N/mm ²	50 °C	75 %	33.3 years	82
2	2 N/mm ²	80 °C	25 %	50.25 years	18

According to the previous equation the service life to be expected on the basis of mechanical stresses is:

$$t_m = \frac{(100 * 33.3 * 50,25)}{(75 * 50,25 + 25 * 33,3)} = 36,4 \text{ years}$$

Then it is possible to consider also the ageing and damage proportions:

Partial stresses	Temperature	Time proportion (a)	Beginning heat aging t_a	Damage proportion %
1	50 °C	75%	91.23 years	35.7
2	80 °C	25%	16.9 years	64.3

The service life to be expected on the basis of the ageing is calculated by the equation:

$$t_a = \frac{(100 * 91,23 * 16,9)}{(75 * 16,9 + 25 * 91,23)} = 43,45 \text{ years}$$

1.10 Creep modulus

The polymeric materials subjected to load can undergo creep phenomena, which is a time dependent deformation of a material exposed to a constant stress.

Therefore under a constant load applied at a constant temperature this deformation continues to increase over time.

Creep modulus is dependent on time, stress, temperature and may also depend on the medium, particularly in case on swelling substances.

For the materials used, the creep modulus can be obtained as a function of the stated parameters from the creep modulus curves.

It is used:

- in stability calculations, with the following equation:

$$E_{c(AI)St} = \frac{E_c}{A_{2E} * S}$$

where:

$E_{c(AI)St}$ = Allowable creep modulus at the design condition for stability (temperature, stress, time, medium,safety factor) (N/mm²)

E_c = Creep modulus at the design condition (temperature, stress, time) (N/mm²)

A_{2E} = Reduction factor taking into account the effect of surrounding medium on the modulus of elasticity

S = Factor of safety

- to determine deformations, with the following equation:

$$E_{c(AI)D} = \frac{E_c}{A_{2E}}$$

where:

$E_{c(AI)D}$ = Allowable creep modulus at the design condition for deformation (temperature, stress, time, medium) (temperature, stress, time, medium,safety factor) (N/mm²)

E_c = Creep modulus at the design condition (temperature, stress, time) (N/mm²)

A_{2E} = Reduction factor taking into account the effect of surrounding medium on the modulus of elasticity

The reduction factor A_{2E} except for mediums causing swelling is $A_{2E} = 1$.

For mediums which cause swelling A_{2E} must be determined by appropriate tests.

As regards the factor of safety S, it denotes that, when the component is used in accordance with the specifications, at any time during its design life, this margin of safety is ensured with respect to the creep strength of the material. The factor of safety therefore also takes into account simplifications made in load assumptions and during design assessment or experimental verification of strength.

The factors of safety in the following table are stated for two loading cases depending on the potential hazard. In each individual case, it is necessary to decide which classification is appropriate for the component to be designed.

If applicable, intermediate values can be appropriate.

Type of loading	S
Loading case 1 Static load at room temperature and constant conditions. No possible danger to persons, objects and environment in the event of failure	1.3
Loading case 2 Loading under alternating conditions (e.g. temperature, filling level). Possible danger to persons, objects and environment in the event of failure	2.0

For stability calculations, use a minimum factor of safety of 2.

Allowance shall be made separately for the effects of eccentricity and out-of-roundness.

The graphs below are the creep modulus curves of thermoplastics according to different stress levels, years and temperatures. They are in accordance with EN 1778 and DVS 2205-1 standards.

Creep modulus of UPVC for the stress range $\sigma = 2.5$ to 10 N/mm^2

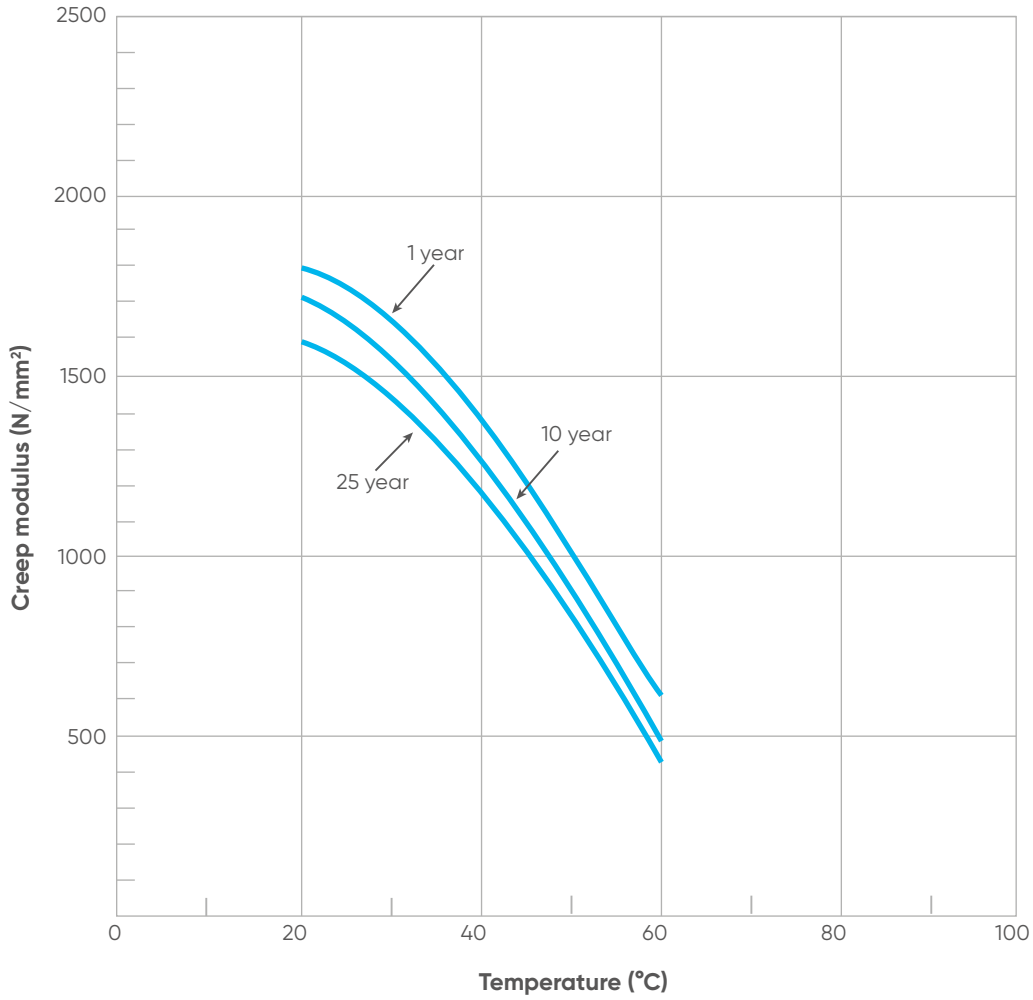

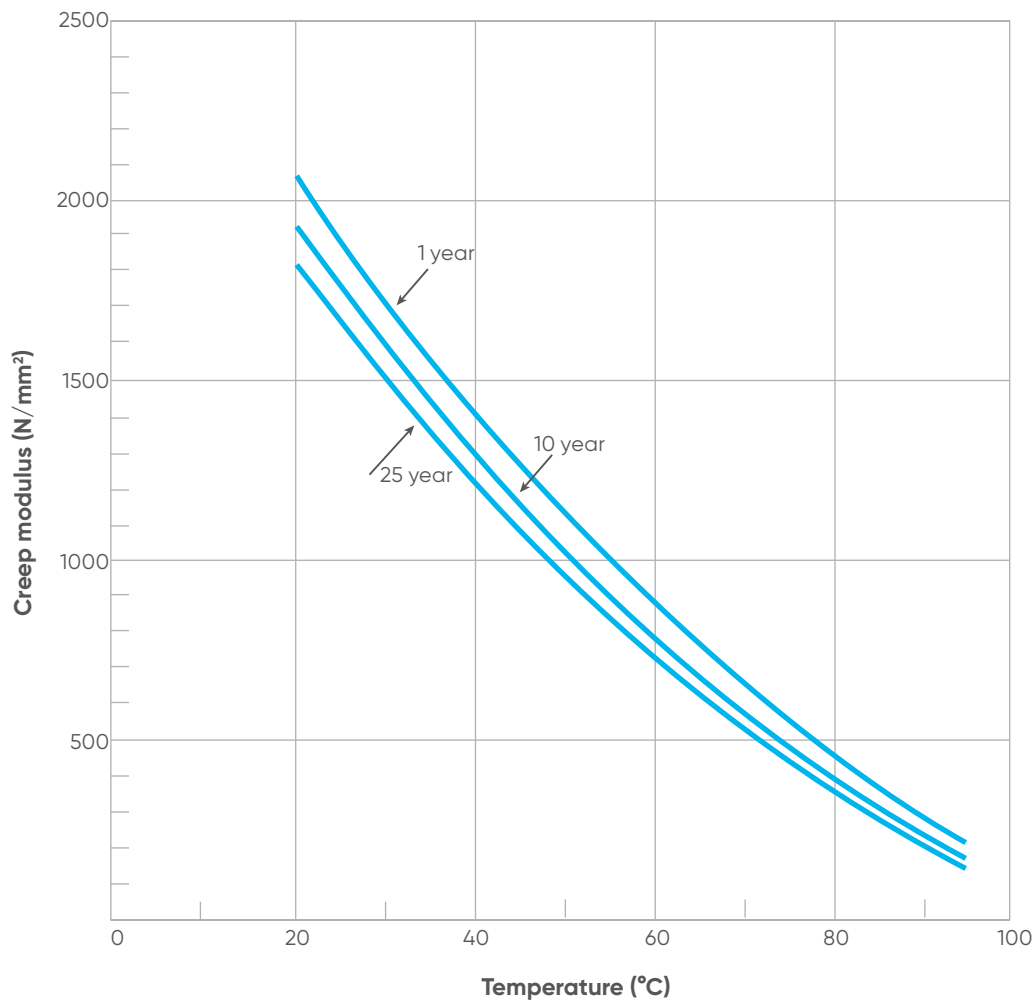
Creep modulus of CPVC for the stress range $\sigma = 5$ to 20 N/mm^2 

Creep modulus of PP-H for 1 year

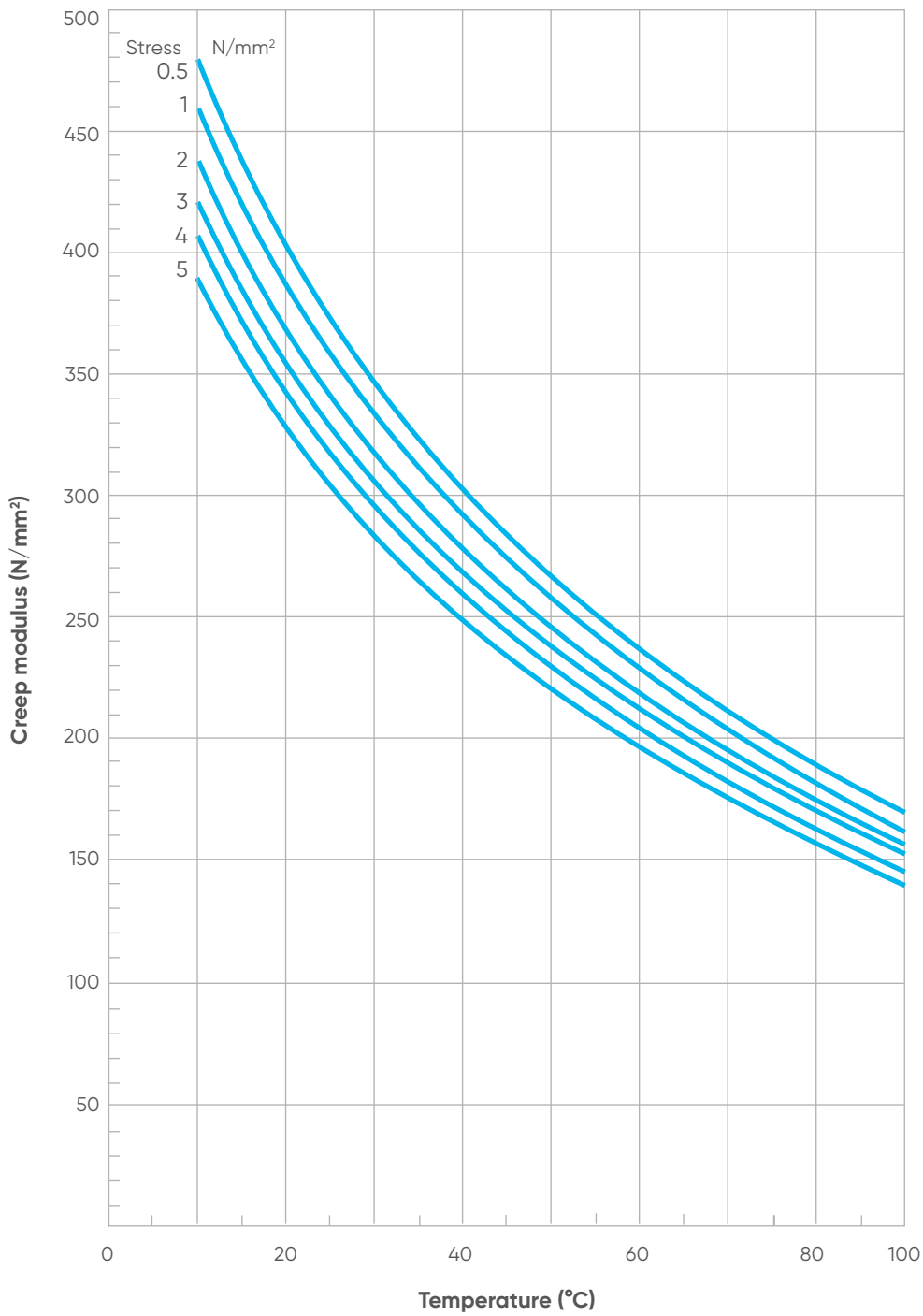

Creep modulus of PP-H for 10 years

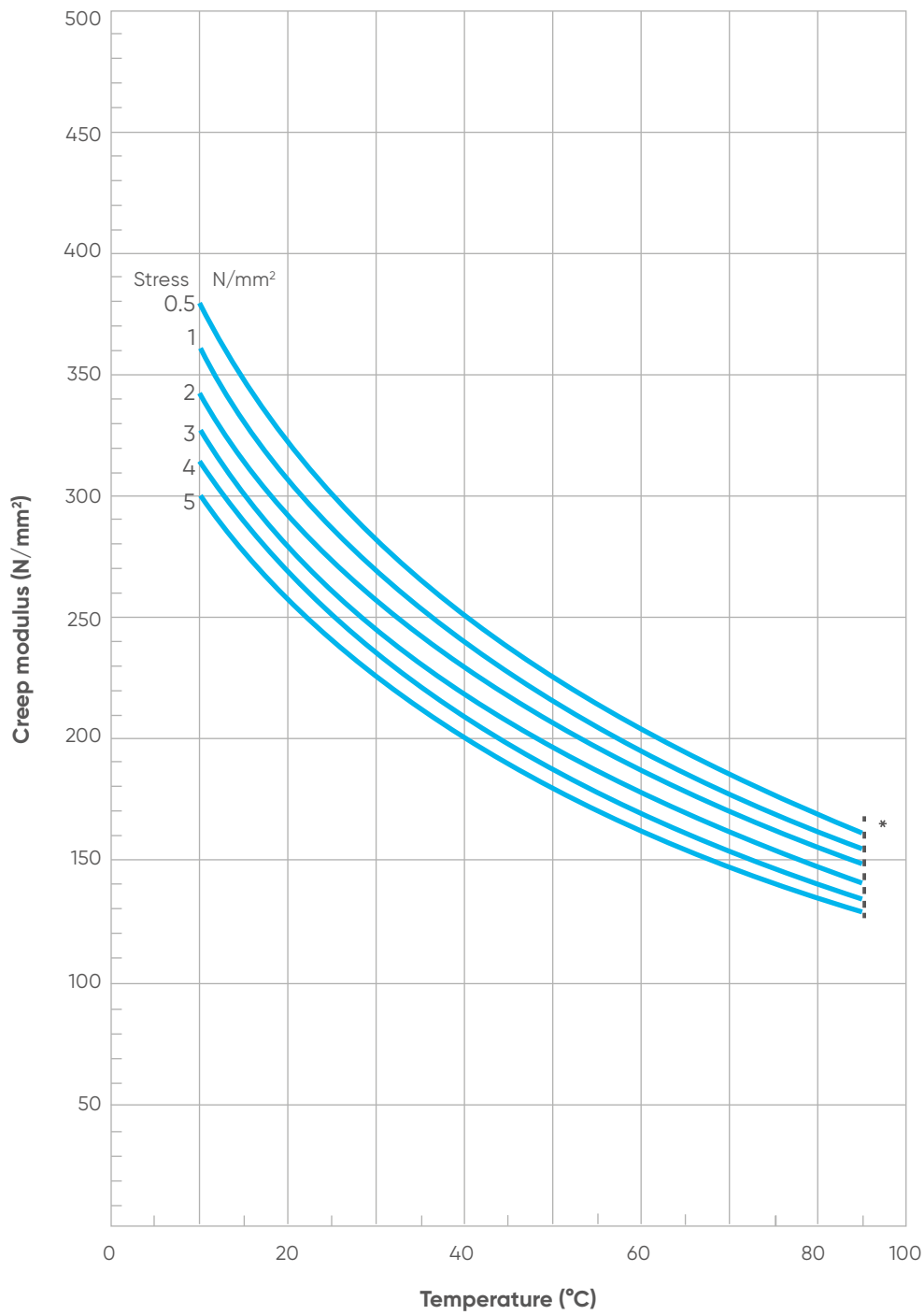

* Start of ageing

Creep modulus of PP-H for 25 years

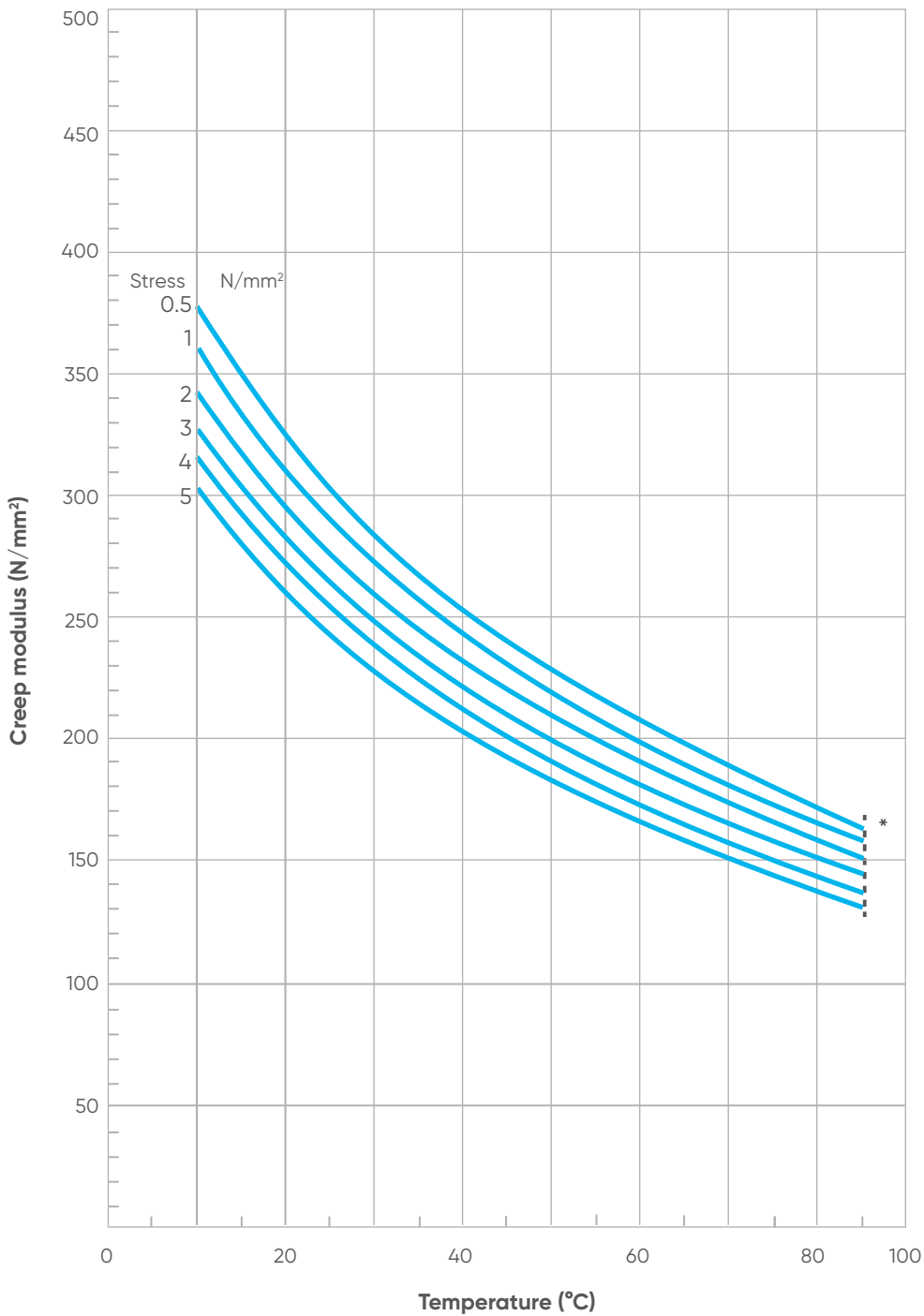

* Start of ageing

Creep modulus of PP-B for 1 year

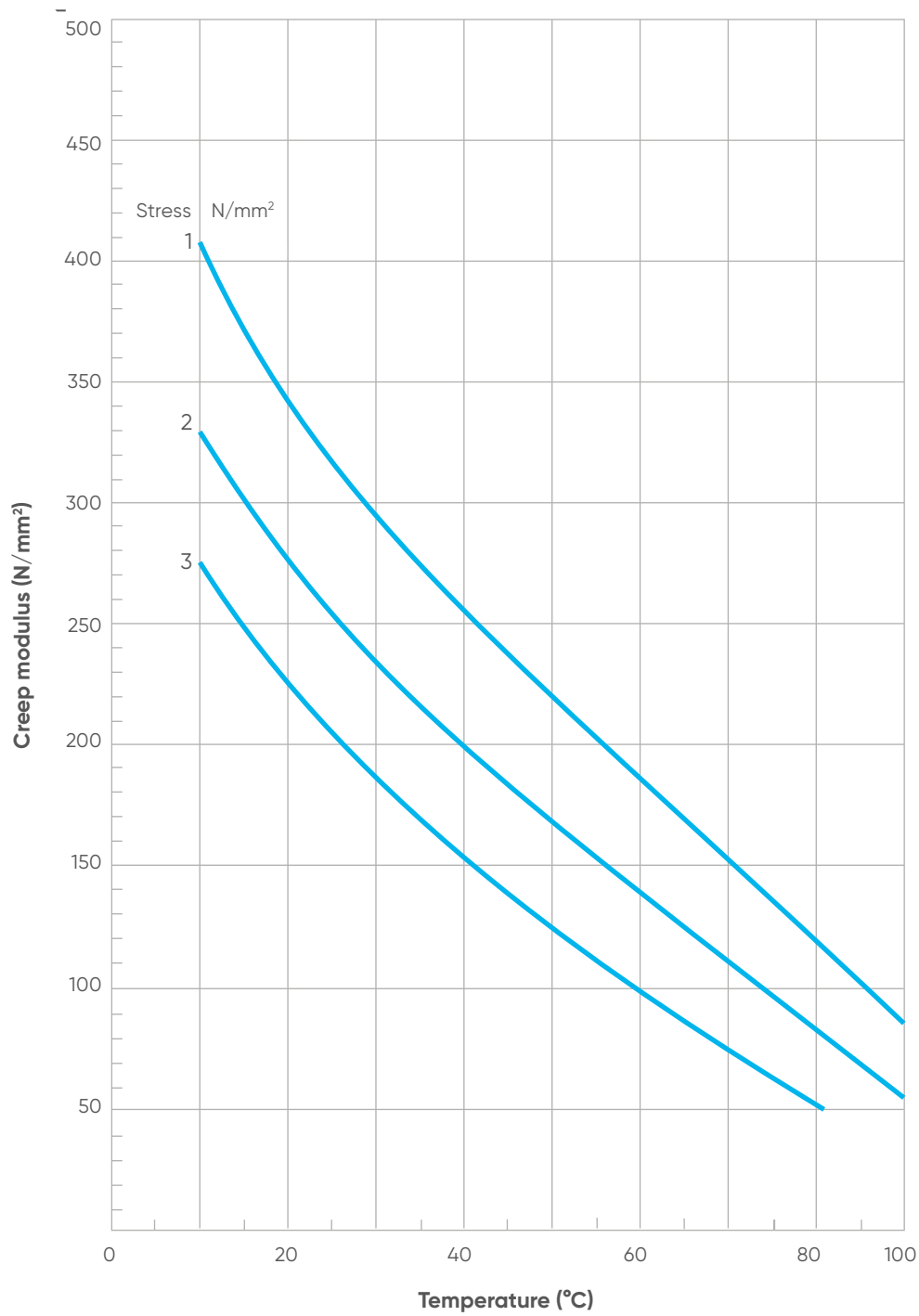

Creep modulus of PP-B for 10 years

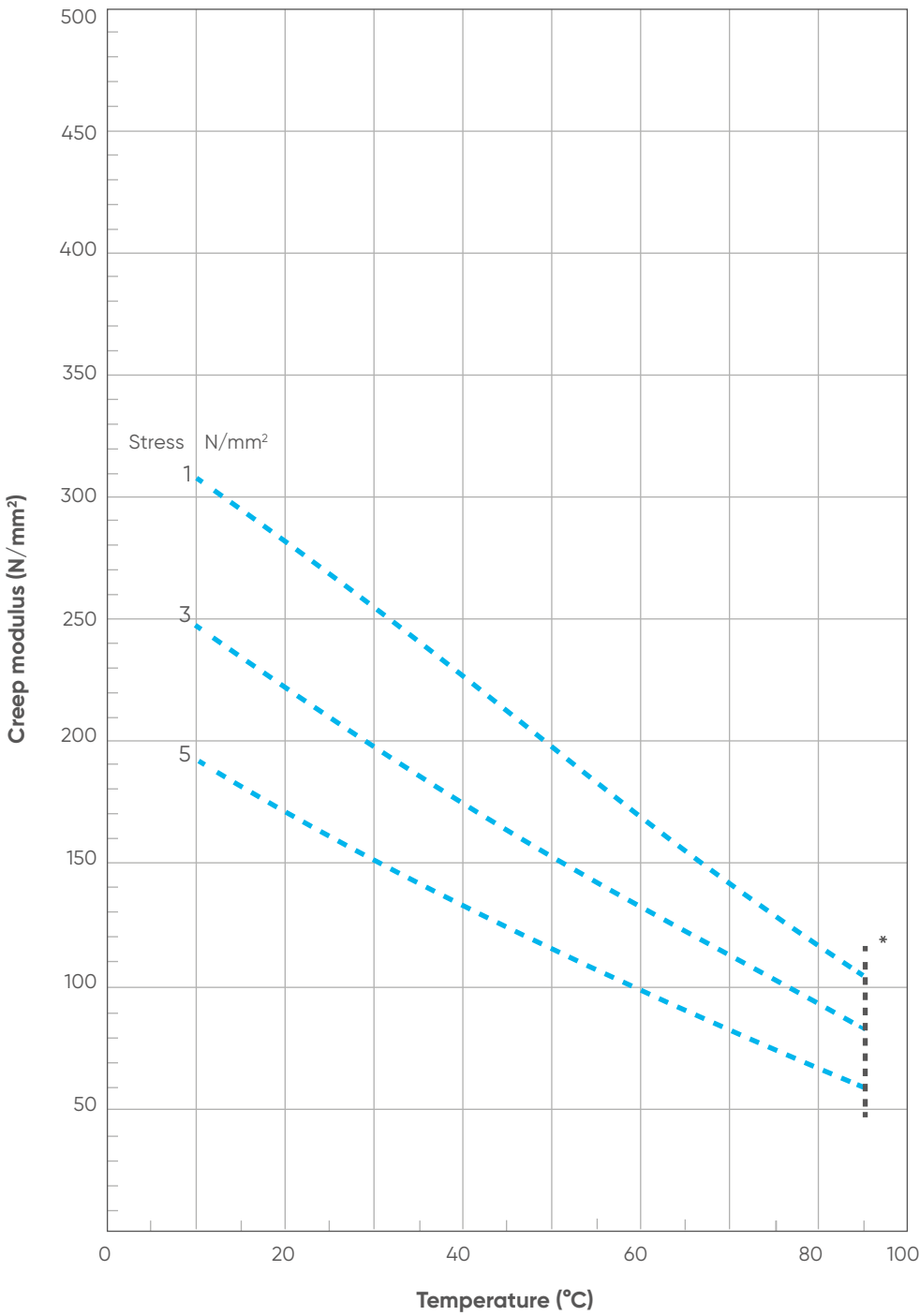

* Start of ageing

Creep modulus of PP-B for 25 years

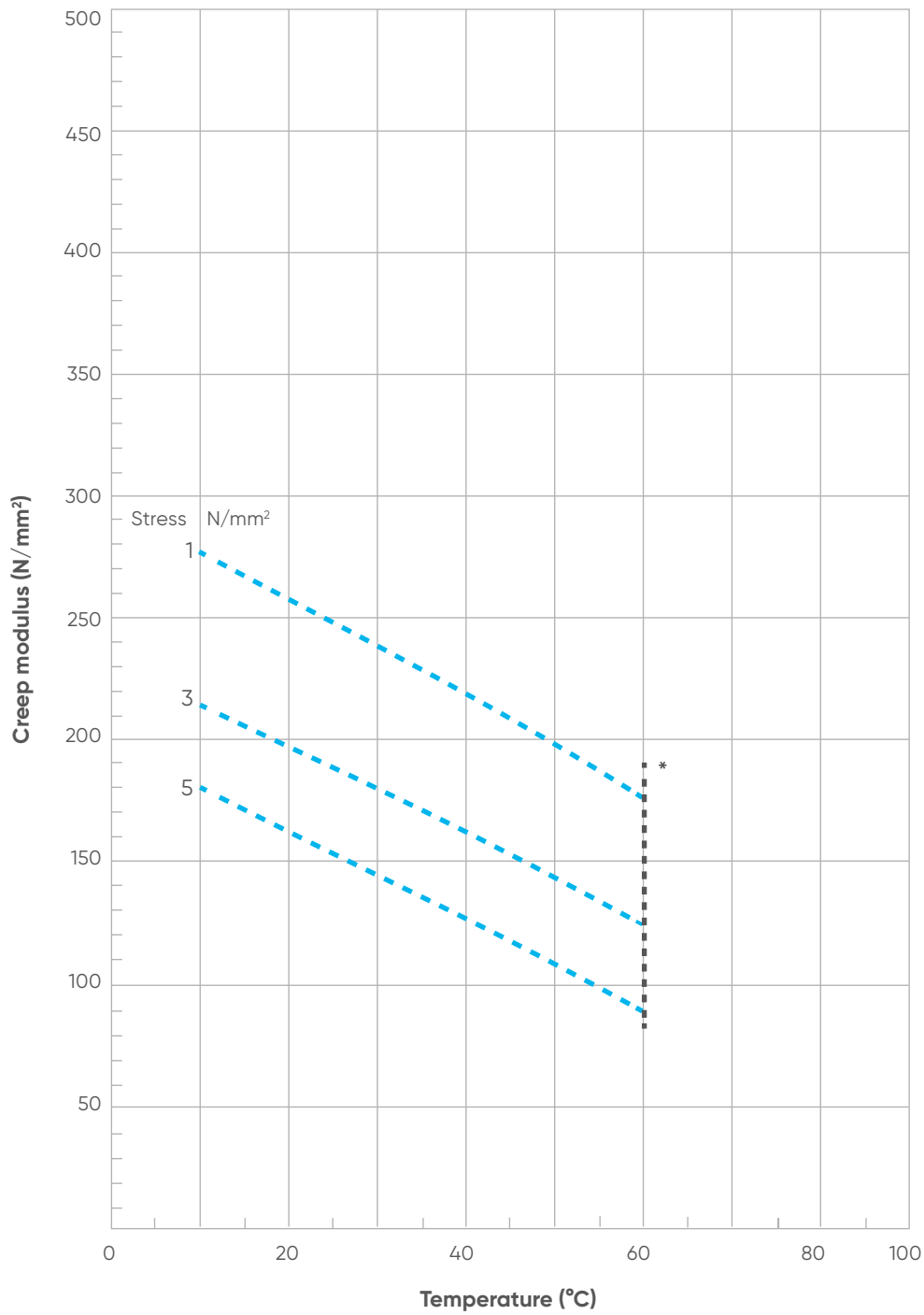

* Start of ageing

Creep modulus of PP-R for 1 year

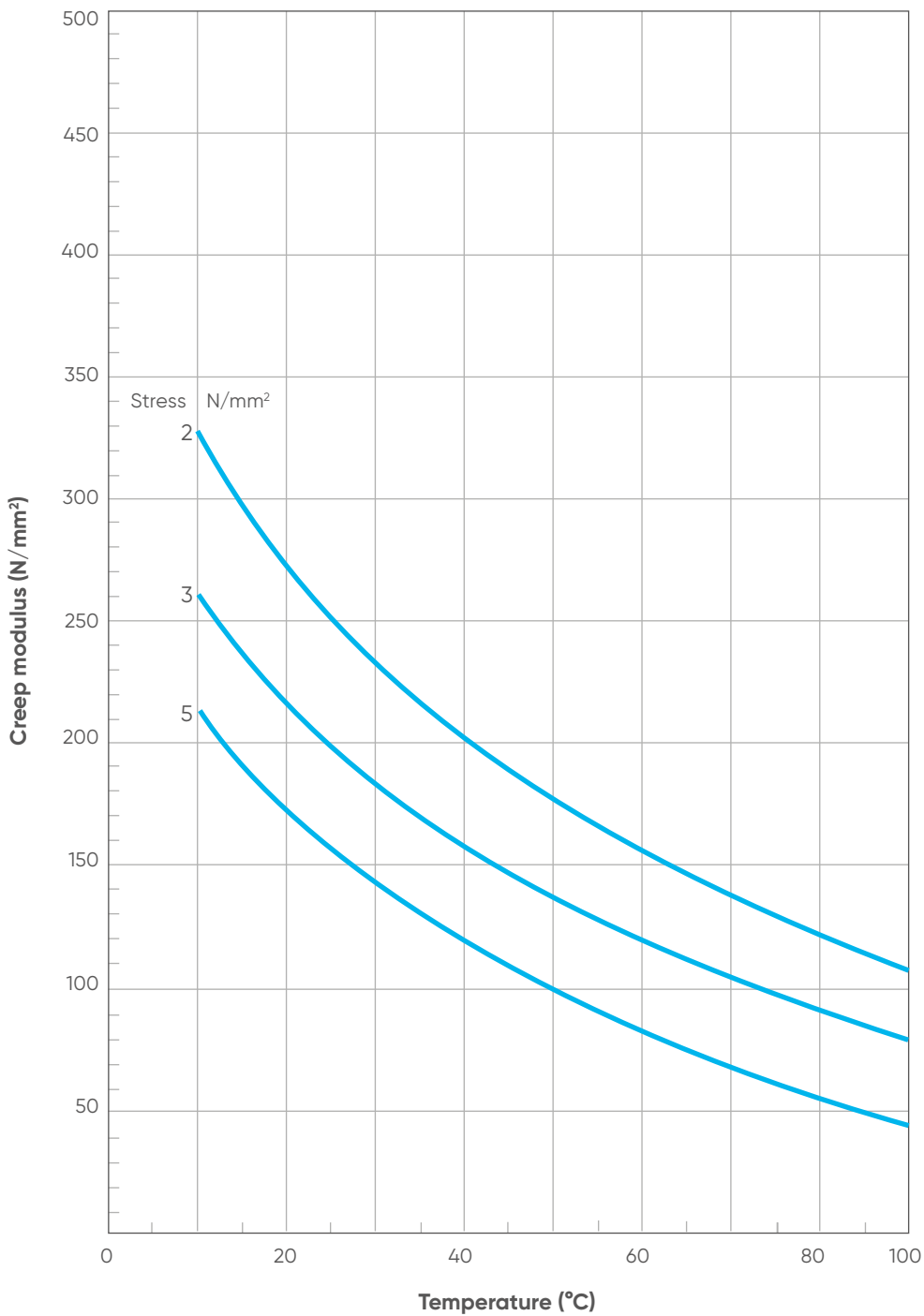

Creep modulus of PP-R for 10 years

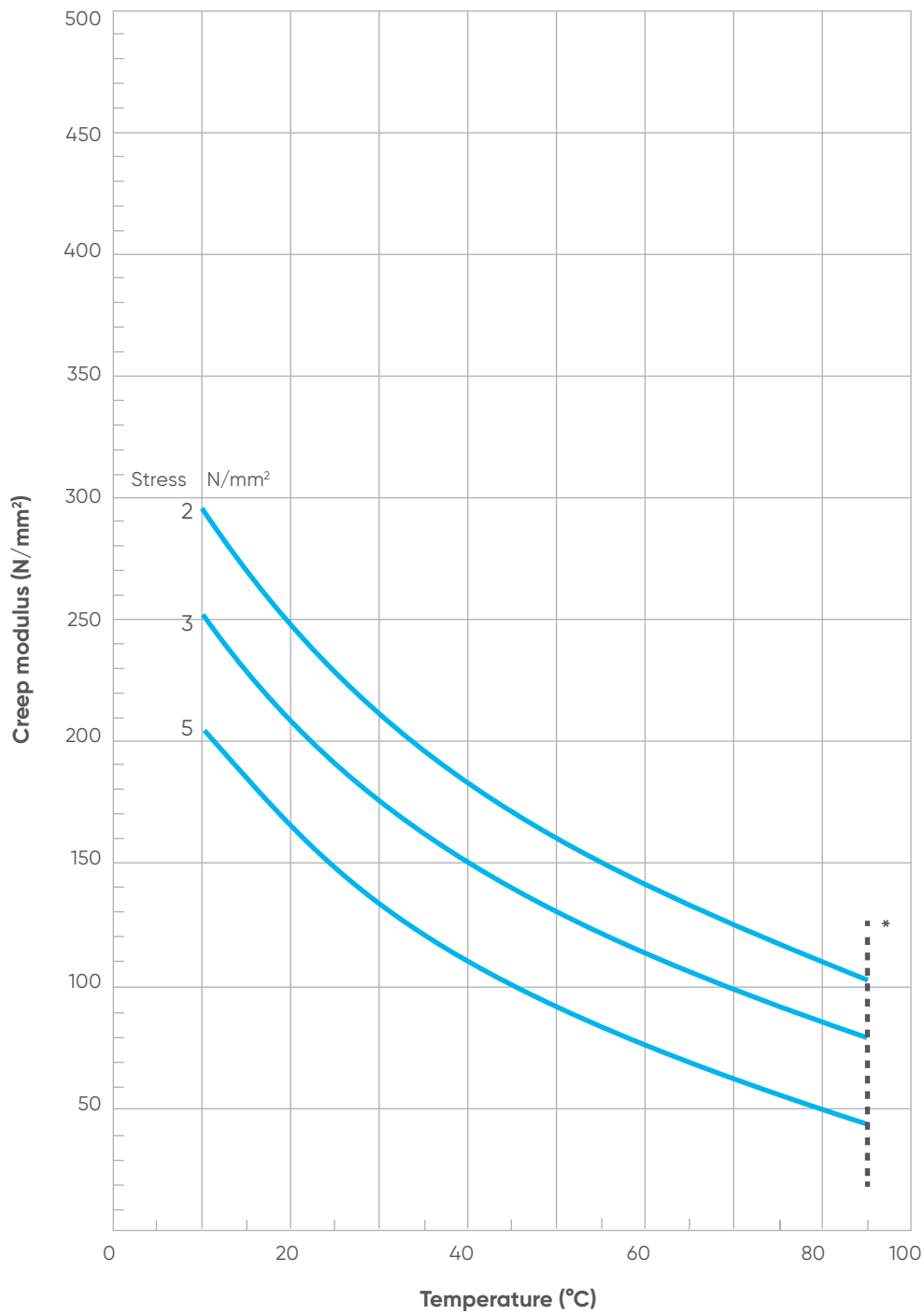

* Start of ageing

Creep modulus of PP-R for 25 years

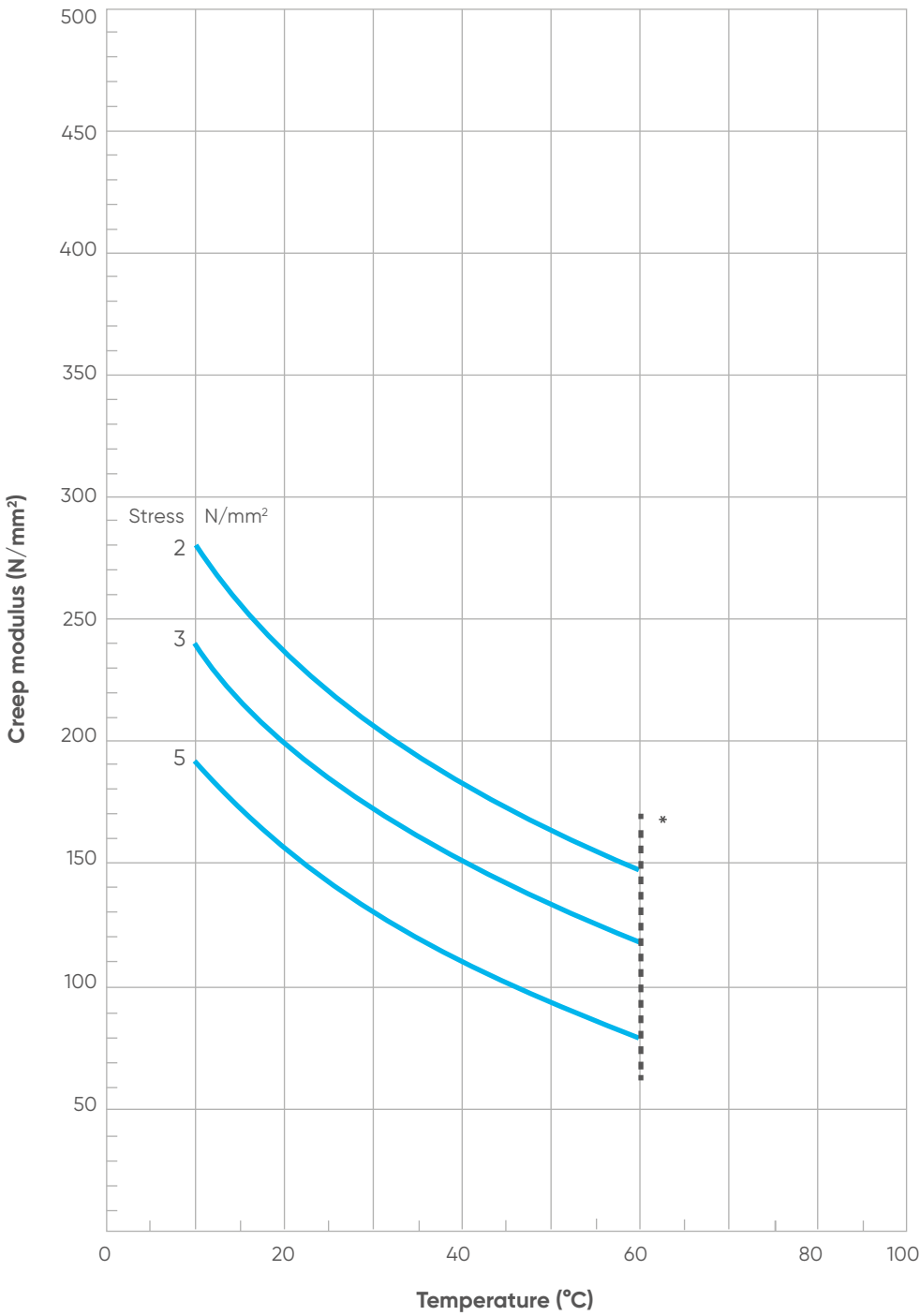

* Start of ageing

Creep modulus of PE-HD for 1 year

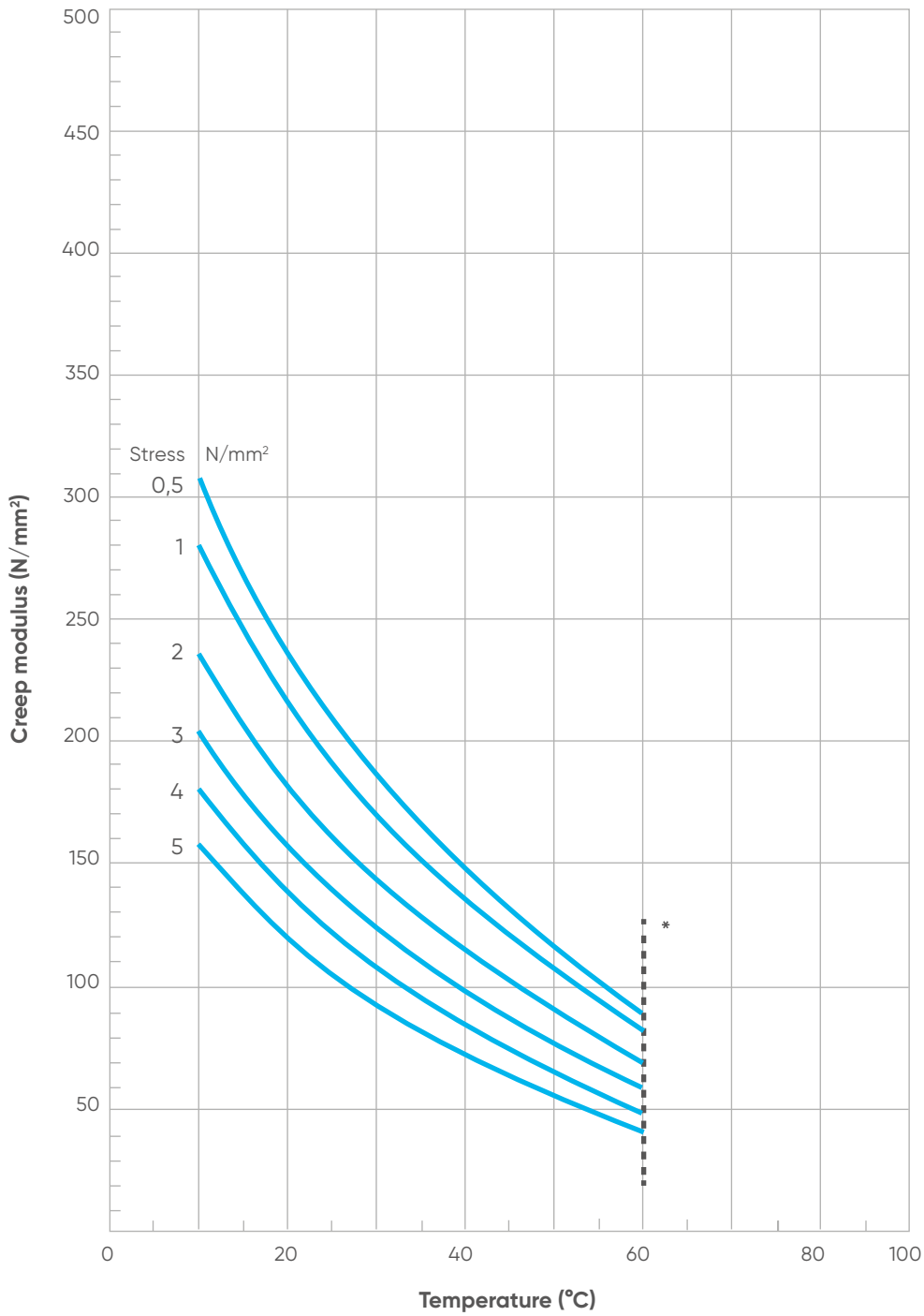

* Start of ageing

Creep modulus of PE-HD for 10 years

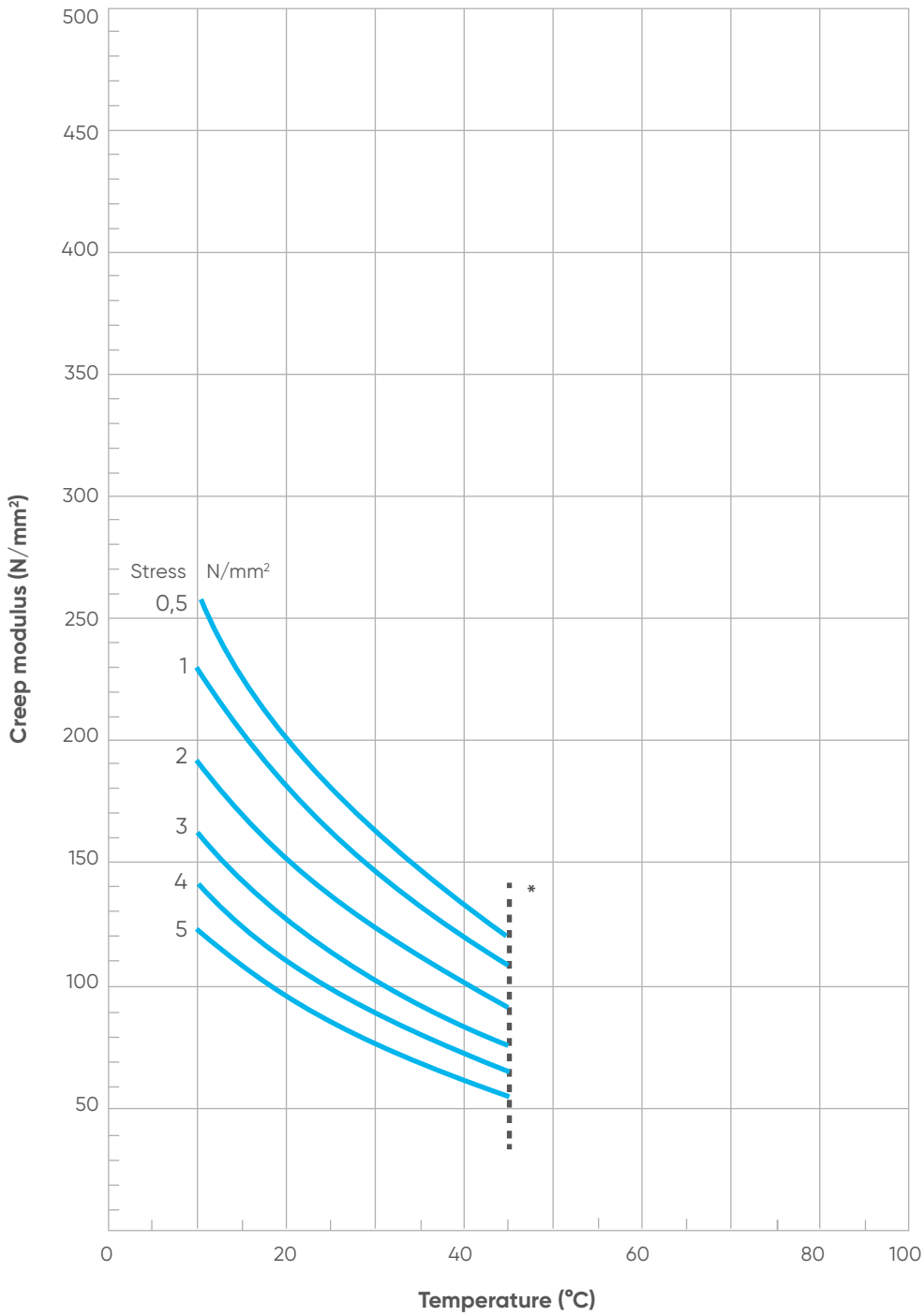

* Start of ageing

Creep modulus of PE-HD for 25 years

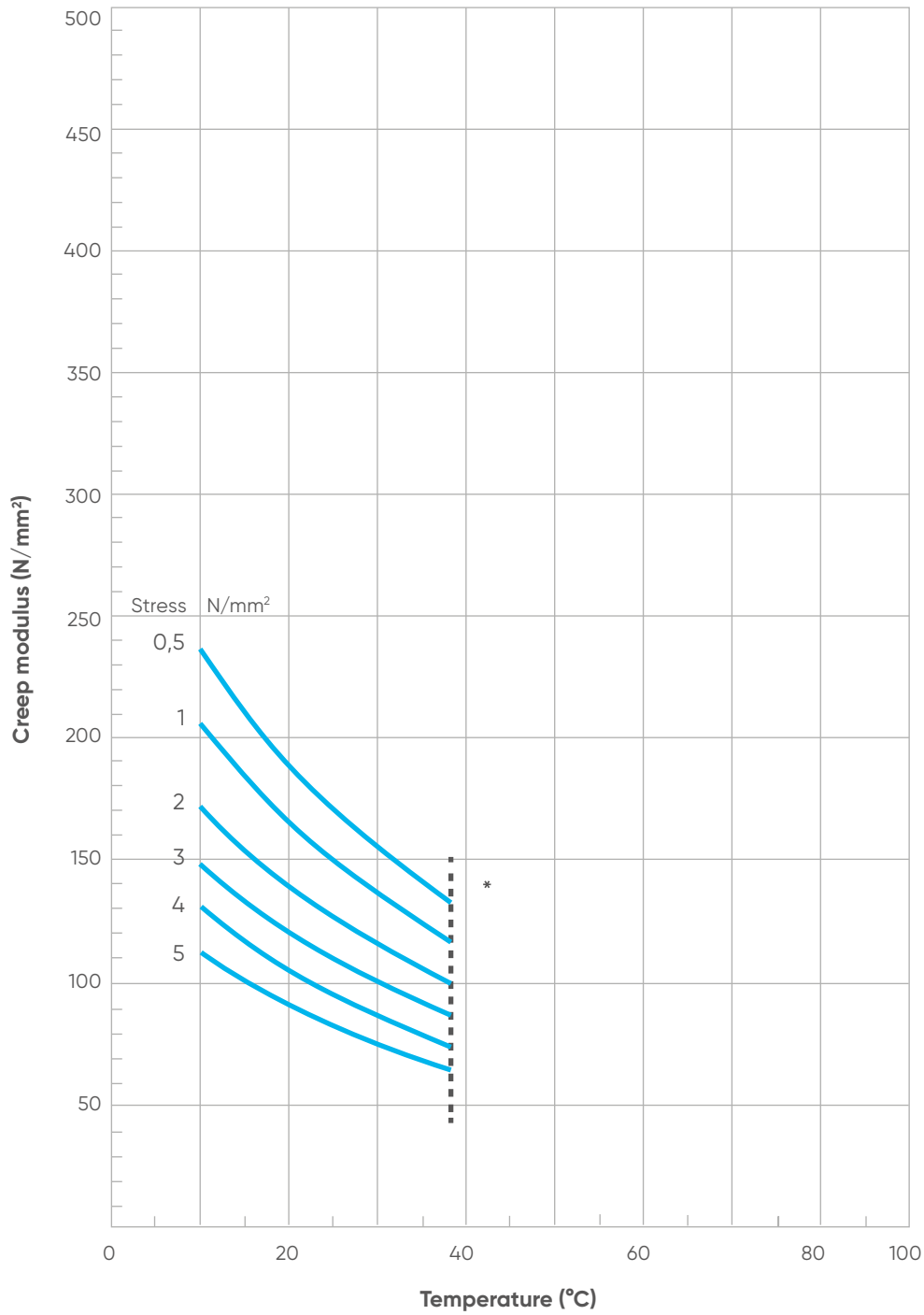

* Start of ageing

Creep modulus of PVDF

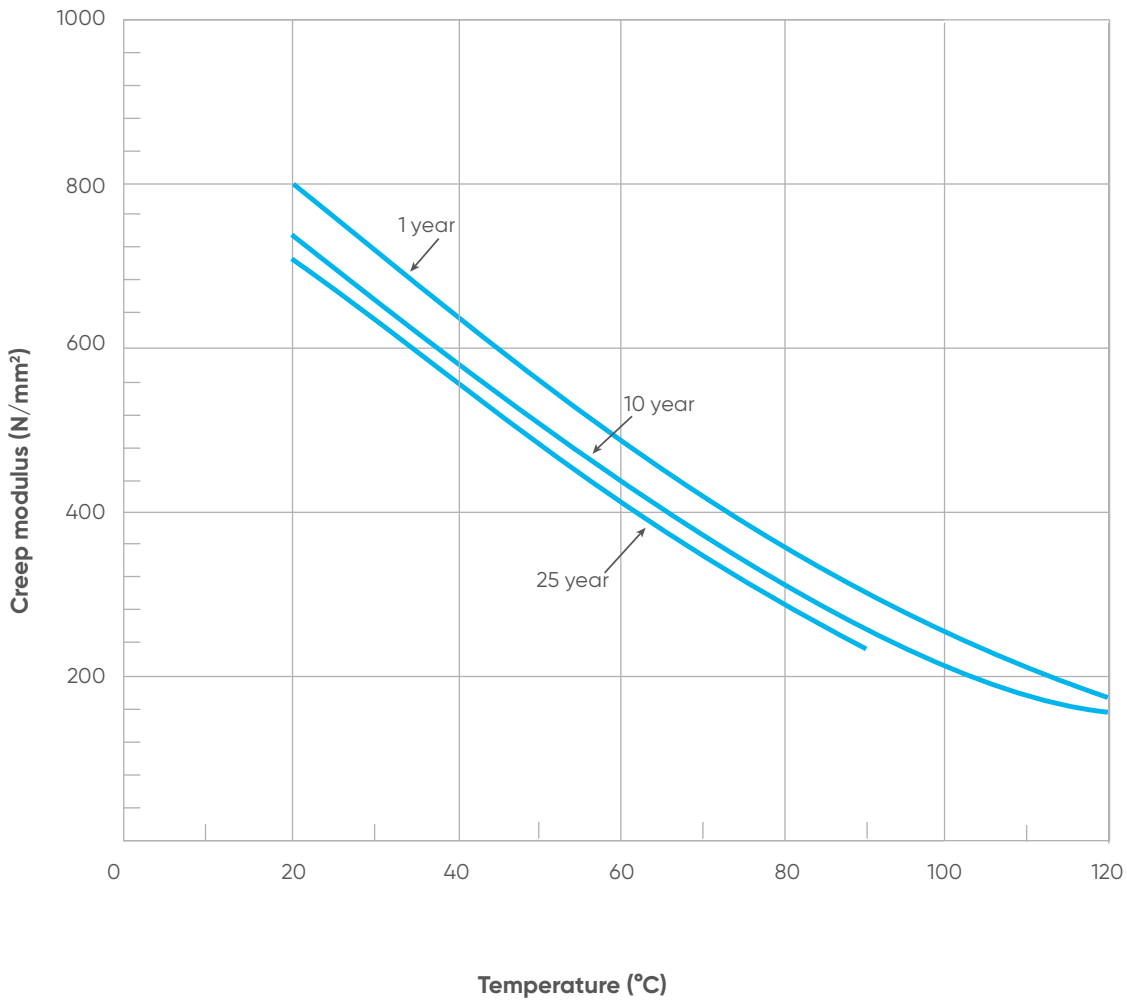



2. Design of plastic piping systems	106
2.1 Symbols, abbreviations, units, conversion tables	106
2.1.1 Symbols	106
2.1.2 Abbreviations	107
2.1.3 Units	109
2.2 Material selection	113
2.3 Chemical resistance	114
2.4 Dimensioning and hydraulic engineering	117
2.4.1 Pipe design	117
2.4.1.1 Calculation of design stress based on MRS classification	117
2.4.1.2 Calculation of nominal pressure	118
2.4.1.3 Calculation of standard dimension ratio	119
2.4.1.4 Calculation of series	119
2.4.1.5 Calculation of wall thickness	119
2.4.2 Pressure-temperature diagram	125
2.4.2.1 Permissible pressure - temperature diagram	126
2.4.2.2 Nominal pressure - temperature diagram	132
2.4.3 Hydraulic calculation	137
2.4.3.1 Distributed head loss calculation	139
2.4.3.2 Localized head loss calculation	142
2.4.4 Valve flow regulation and sizing	147
2.4.5 Pressure surge	151
2.4.5.1 Water hammer	151
2.4.5.2 Cavitation	154
2.5 Valve selection and features	156
2.5.1 Fluid characteristics	156
2.5.2 Mechanical stress and vibrations	157
2.5.3 Safety	160
2.5.4 Security	161
2.5.5 Easy installation	161
2.5.6 Accurate regulation	162
2.6 Air release from pipelines	163
2.6.1 Entrapped air: sources and causes	163
2.6.2 Dealing with entrapped air	164
2.7 Piping system design for vacuum condition	165
2.8 Piping system design for compressed air	166
2.9 Selection of flowmeter	169
2.9.1 Flowmeter design	169
2.9.1.1 Insertion flow sensors	169
2.9.1.2 In line flow sensors	171
2.9.1.3 Variable area flowmeters	172
2.9.2 Flowmeter installation	174
2.9.2.1 Insertion flow sensors	174
2.9.2.2 In line flow sensors	176
2.9.2.3 Variable area flowmeters	176
2.10 Selection of pH and ORP sensor	178
2.10.1 pH and ORP sensor design	178
2.10.1.1 pH measurement	178
2.10.1.2 ORP measurement	181
2.10.1.3 pH/ORP electrodes	182
2.10.2 pH and ORP sensor installation	184
2.10.2.1 Installation guidelines	184
2.10.2.2 Operating guidelines	185
2.11 Selection of conductivity sensor	186
2.11.1 Conductivity sensor design	186
2.11.1.1 Conductivity measurement	186
2.11.1.2 Conductivity electrodes	188
2.11.2 Conductivity sensor installation	189
2.11.2.1 Installation guidelines	189
2.11.2.2 Operating guidelines	190

2. Design of plastic pipe systems

2.1 Symbols, abbreviations, units, conversion tables

2.1.1 Symbols

The following table shows main symbols used to represent connections and valves in common design documentation, as P&ID or general drawings.

Symbols	Connection	Symbols	Valves
	Pipe		Valve, general
	Pipe, insulated		Ball valve
	Crossing without connection		Diaphragm valve
	Tee		Flap trap
	Flange connection		Pump
	Hose		Valve, flanged
	Slope		Butterfly valve
	Connection		Check valve
	Reduction		Actuator
	Container, flanged		

2.1.2 Abbreviations

Material abbreviation	Material name
UPVC	Unplasticised Polyvinylchloride
CPVC	Postchlorinated Polyvinylchloride
ABS	Acrylonitrile-Butadiene-Styrene
PP	Polypropylene
PPH	Polypropylene Homopolymer
PPB	Polypropylene Block Copolymer
PPR	Polypropylene Random Copolymer
PP-EL	Polypropylene Electrically Conductive
PE	Polyethylene
PE-RC	Polyethylene Resistant to Cracks
PVDF	Polyvinylidene fluoride
PA	Polyamide
PB	Polybutadiene
PE-X	Cross-linked polyethylene
EPDM	Ethylene Propylene Diene Monomer Rubber
FKM	Fluoroelastomer
FFKM	Perfluoroelastomer
PTFE	Polytetrafluorethylene
NBR	Nitrile rubber

Abbreviation	Name
MRS	Minimum Required Strength
σ	Design stress
C	Design coefficient
Cmin	Minimum design coefficient
F_j	Long term joint factor
F_c	Chemical factor
F_t	Toughness factor
PN	Nominal pressure
DN	Nominal diameter
D_i	Internal diameter
D_e	External diameter
SDR	Standard Dimension Ratio
T	Temperature
t	Wall thickness
r	Pipe radius
t_m	Service life under mechanical load
t_a	Service life under influence of aging
Q	Flow rate
V	Flow velocity
V_a	Average velocity
V_m	Maximum velocity
Re	Reynold's Number
μ	Dynamic viscosity
ν	Kinematic viscosity
h	Pressure drop
g	Gravity acceleration
λ	Friction coefficient
A	Pipe section
Chw	Hazen and William flow coefficient
Δp_{RF}	Pressure loss in fittings
Δp_{RV}	Pressure loss at pipe joints
Δp_{geod}	Pressure difference due to elevation
Δp_{valv}	Pressure loss inside a valve
ϵ_{RF}	Resistance coefficient of the fittings
ϵ_{RV}	Resistance coefficient of the joints
Δh_{geod}	Difference in elevation of pipeline
K_v	Standard flow rate coefficient
t_c	Water hammer perturbation propagation time
V_{pw}	Velocity of pressure wave
P_k	Buckling pressure
σ_k	Buckling tension
E_c	Creep modulus
f	frequency
Ep	Potential between two electrodes
E_0	Standard potential

Abbreviation	Name
n	Charge of ion
F	Faraday constant
R	Resistance
K	Cell constant
d	Distance between electrodes
S	Surface of electrode
S _m	Chamfer length
κ	conductivity
E	Modulus of Elasticity or Young's Modulus
ε	Strain
t _f	Time to failure
α	Angular deflection
f _m	maximum deflection sag
L	distance between supports
L _p	Peeling length
L _i	Length of insertion
M	Trench depth
m	Minimum trench width
I	moment of inertia
k	elastic deflection coefficient
W	static loads
P _p	pipe weight
P _f	weight of the conveyed fluid
s	specific gravity of the fluid at the service conditions
L _A	Pipe support span width
T _B	Operating temperature
T _R	Room temperature
R _p	Distance between pipe ends
X	Pipe out of roundness value

2.1.3 Units

In the following table International System of Units is listed.

Base size Name	Sign	SI base units Name	Sign
Length	l	Meter	m
Mass	m	Kilogram	kg
Time	t	Second	s
Electric current	I	Ampere	A
Thermodynamic temperature	T	Kelvin	K
Amount of substance	n	Mole	mol
Luminous intensity	ln	Candela	cd

Next table shows the internationally defined prefixed.

Meaning	Prefix Name	Sign	Factor as Decimal power	Decimal number
Quintillion	exa	E	10^{18}	= 1 000 000 000 000 000 000
Quadrillion	peta	P	10^{15}	= 1 000 000 000 000 000
Trillion	tera	T	10^{12}	= 1 000 000 000 000
Billion	giga	G	10^9	= 1 000 000 000
Million	mega	M	10^6	= 1 000 000
Thousand	kilo	k	10^3	= 1 000
Hundred	hecto	h	10^2	= 100
Ten	deka	da	10^1	= 10
Tenth	deci	d	10^{-1}	= 0.1
Hundredth	centi	c	10^{-2}	= 0.01
Thousandth	milli	m	10^{-3}	= 0.001
Millionth	micro	μ	10^{-6}	= 0.000 001
Billionth	nano	n	10^{-9}	= 0.000 000 001
Trillionth	pico	p	10^{-12}	= 0.000 000 000 001
Quadrillionth	femto	f	10^{-15}	= 0.000 000 000 000 001
Quintillionth	atto	a	10^{-18}	= 0.000 000 000 000 000 001

Next table shows several sizes with their SI units and conversions.

Size	SI unit	Permissible units outside of SI	Conversion into corresponding SI unit and relationships	Other units and conversions outside of SI
Length	m			1" = 0.0254 m 1 Sm = 1852 m
Area	m ²			1 b = 10 ⁻²⁸ m ² 1 Sm = 1852 m 1 a = 10 ² m ² 1 ha = 10 ⁴ m ²
Volume	m ³	l	1 l = 10 ⁻³ m ³	
Solid angle	SR		1 sr = 1 m ² /m ²	1° = 3.046 • 10 ⁻⁴ sr 1 g = 2.467 • 10 ⁻⁴ sr
Time	s	min h d	1 min = 60 s 1 h = 3600 s 1 d = 86 400 s	
Frequency	Hz		1 Hz = 1/s	
Speed, rotational frequency	s ⁻¹	min ⁻¹ U/min	1 min ⁻¹ (1/60) s ⁻¹ 1 U/min = 1 (1/min)	
Velocity	m/s	km/h	1 km/h = (1/3.6) m/s	
Acceleration	m/s ²			1 Gal = 10 ⁻² m/s ²
Mass	kg	t	1 t = 10 ³ kg	1 q = 50 kg
Density	kg/m ³	t/m ³ kg/l	1 t/m ³ = 1000 kg/m ³ 1 kg/l = 1000 kg/m ³	
Moment of inertia	kg • m ²			1 kp • ms ² = 9.81 kg • m ²
Force	N		1 N = 1 kg • m/s ²	1 dyn = 10 ⁻⁵ N 1 p = 9.80665 • 10 ⁻³ N 1 kp = 9.80665 N

Size	SI unit	Permissible units outside of SI	Conversion into corresponding SI unit and relationships	Other units and conversions outside of SI
Torque	N · m			1 kpm = 9.80665 Nm 1 Nm = 0.7375 lb-ft
Pressure	Pa	bar	1 Pa = 1 N/m ² 1 bar = 105 Pa	1 atm = 1.01325 bar 1 at = 0.980665 bar 1 Torr = 1.333224 · 10 ⁻³ bar 1 m WS = 98.0665 · 10 ⁻³ bar 1 mm Hg = 1.333224 · 10 ⁻³ bar
Stress	N/m ² Pa		1 N/m ² = 1 Pa	1 kp/m ² = 9.80665 N/m ² 1 kp/cm ² = 98.0665 · 10 ⁻³ N/m ² 1 kp/mm ² = 9.80665 · 10 ⁻⁶ N/m ²
Dynamic viscosity	Pa · s		1 Pa · s = 1 N · s/m ²	1 P (Poise) = 10 ⁻¹ Pa · s
Kinematic viscosity	m ² /s		1 m ² /s = 1 Pa · s · m ³ /kg	1 St (Stokes) = 10 ⁻⁴ m ² /s
Work, energy	J	eV W · h	1 J = 1 Nm = 1 WS 1 W · h = 3.6 KJ	1 cal = 4.1868 J 1 kpm = 9.80665 J 1 erg = 10 ⁻⁷ J
Electric charge	C		1 C = 1 A · s	
Electric voltage	V		1 V = 1 W/A	
Electric current	A			
Electric resistance	Ω		1 Ω = 1 V/A	1 Ω abs = 1 Ω
Power	W		1 W = 1 J/s = 1 Nm/s 1 W = 1 V · A	1 PS = 735.498 W 1 kcal/h = 1.163 W 1 kpm/s = 10 W
Electric capacitance	F		1 F = 1 C/V	
Magnetic field strength	A/m			1 Oe = 79.5775 A/m
Magnetic flux	Wb		1 Wb = 1 V · s	1 Mx = 10 ⁻⁸ Wb
Magnetic flux density	T		1 T = 1 Wb/m ²	1 G = 10 ⁻⁴ T
Inductance	H		1 H = 1 Wb/A	
Electric conductance	S		1 S = 1/Ω	
Thermodynamic temperature	K		Δ 1 °C = Δ 1 K	0 °C = 273.15 K
Celsius; temperature	°C		Δ 1 °C = Δ 1 K 0 K = -273.15 °C	
Thermal capacity	J/K			1 Kcl/grad = 4.1868 · 10 ⁻³ J/K

Following table shows conversions about flow rate.

m ³ /h	l/min	l/s	m ³ /s	Imp. gal/min	US gal/min	cu. ft./h	cu. ft./s
1.0	16.67	0.278	2.78•10 ⁻⁴	3.667	4.404	35.311	9.81 • 10 ⁻³
0.06	1.0	0.017	1.67 • 10 ⁻⁵	0.220	0.264	2.119	5.89 • 10 ⁻⁴
3.6	60	1.0	1.00 • 10 ⁻³	13.20	15.853	127.12	3.53 • 10 ⁻²
3 600	60 000	1000	1.0	13 200	15 838	127 118	35.311
0.2727	4.55	0.076	7.58 • 10 ⁻⁵	1.0	1.201	9.629	2.67 • 10 ⁻³
0.2272	3.79	0.063	6.31 • 10 ⁻⁵	0.833	1.0	8.0238	2.23 • 10 ⁻³
0.0283	0.47	0.008	7.86 • 10 ⁻⁶	0.104	0.125	1.0	2.78 • 10 ⁻⁴
101.94	1 699	28.32	2.83 • 10 ⁻²	373.77	448.8	3 600	1.0

Following table shows conversions about pressure.

bar	kg/cm ²	lbf/in ²	atm	ft H ₂ O	m H ₂ O	mm Hg	in. Hg	kPa
1.0	1.0197	14.504	0.9869	33.455	10.197	750.06	29.530	100
0.9807	1.0	14.223	0.9878	32.808	10	735.56	28.959	98.07
0.0689	0.0703	1.0	0.0609	2.3067	0.7031	51.715	2.036	6.89
1.0133	1.0332	14.696	1.0	33.889	10.332	760.0	29.921	101.3
0.0299	0.0305	0.4335	0.0295	1.0	0.3048	22.420	0.8827	2.99
0.0981	0.10	1.422	0.0968	3.2808	1.0	73.356	2.896	9.81
13.3 • 10 ⁻⁴	0.0014	0.0193	13.2 • 10 ⁻⁴	0.0446	0.0136	1.0	0.0394	0.133
0.0339	0.0345	0.4912	0.0334	1.1329	0.3453	25.40	1.0	3.39
1.0 • 10 ⁻⁵	10.2 • 10 ⁻⁶	14.5 • 10 ⁻⁵	9.87 • 10 ⁻⁶	3.34 • 10 ⁻⁴	10.2 • 10 ⁻⁵	75.0 • 10 ⁻⁴	29.5 • 10 ⁻⁵	1.0

2.2 Material selection

The selection of the plastic material is a crucial choice to obtain an effective and successful design, because it allows to reach the desired functionality, safety and the specified minimum service life of the system.

A piping material is selected by common piping practices and influencing factors that could be summed up with the word «STAMP», made of size, temperature, application, media and pressure.



In this way, in order to choose the right material and make a correct use of it, it is important to solve some questions, such as:

- What is the application of the material?
- What is the media I want to transport? And what is its concentration?
- What size or flow rate is required?
- What is the operating pressure?
- What is the operating temperature?
- Is it an above ground or buried application?
- Are there Codes and Standards that permit or limit the use of plastics?

To get the right answers some factors may be considered, first of all the composition of the fluid going through the pipe; in particular it is necessary to study its chemical characteristics and think of undesired variations of composition in order to select the proper solution.

It might be useful to start by looking at the chemical resistance of the desired piping material: generally thermoplastic resins are characterized by a high resistance to a wide variety of fluids, but this can change according to the chemical agent, variation of temperature or stress, so it is important to pay attention to consider each factor that can influence the final choice.

Then it is suggested to check parameters linked to the process flow: in this way the required flow rate can be set according to desired velocity and minimum and maximum operating pressure.

To do this, it is also necessary to take into account any pressure changes that might develop since these can affect the sizing of the entire system.

As regards pressure drops, they may be distributed in the pipes or located inside the fittings, joints or valves.

On the other hand, a pressure increase called water hammer may occur if there is an abrupt stop of the flow. Even in this case its effects must be evaluated in advance to get the correct size of the complex.

Another important factor that can influence the process is its location and the environment around it: different materials have to be used according to if the system is buried or if it is located above ground or overhead.

Even external temperature should be considered because of possible fluctuations: going from an extremely hot to a cold climate might generate several effects on plastic material such as expansion or contraction that have to be managed and considered during the design project.

As regards installation, enough place should be provided: pipes should not cause any obstruction that would prohibit personnel or traffic access and not interfere with other equipment items' accessibility for maintenance. Obviously, storage should avoid potential fire risk areas.

Last but not least budget considerations: every factor previously discussed has to take into account the material, installation and maintenance cost.

By taking into consideration every one of these parameters, if a good choice and a good use of the material is done, an extremely high life expectancy is insured.

2.3 Chemical resistance

According to the chemical resistance it is possible to classify every plastic material and to understand its behaviour in relation to different kinds of chemical reagents.

Thermoplastic resins, depending on their molecular structure, are characterized by a high resistance to a wide range of fluids. Anyway, this inertia is significantly influenced by the operating conditions to which the thermoplastic material is subjected, as variations in the composition of the chemical agent, temperature, static and dynamic stresses that can cause decomposition phenomena which reduce the lifetime of the material.

As said before, since the chemical resistance of a material might be easily influenced by temperature, it can be useful to discuss about the relationship between reaction rate of a chemical reaction and its temperature.

This topic can be summed up in just one formula, the Arrhenius equation, that describes how the rate constant or kinetic constant grows exponentially as the temperature increases.

Arrhenius equation can be written as:

$$k = k_0 * e^{\left(\frac{-E_a}{R*T}\right)}$$

where:

k = rate constant (frequency of collisions resulting in a reaction), used to calculate the reaction rate

k_0 = pre-exponential factor, a constant for each chemical reaction

E_a = activation energy for the reaction (J/mol)

R = universal gas constant (J/mol*K)

T = temperature (K)

To explain better, it is necessary to remember that to have a chemical reaction the molecules of the reactants must collide with a sufficiently violent energy to overcome the so-called activation energy, that is the minimum energy needed by a system to start a reaction.

At a certain temperature not all molecules have sufficient kinetic energy to exceed the value of activation energy but as the temperature raises, the fraction of molecules that has a kinetic energy higher than the activation energy increases.

On the other hand, by writing the Arrhenius equation as:

$$\ln k = \ln k_0 - \frac{E_a}{R*T}$$

It can be noticed that raising the temperature $\ln k$ decreases, as can be seen in the graphic.

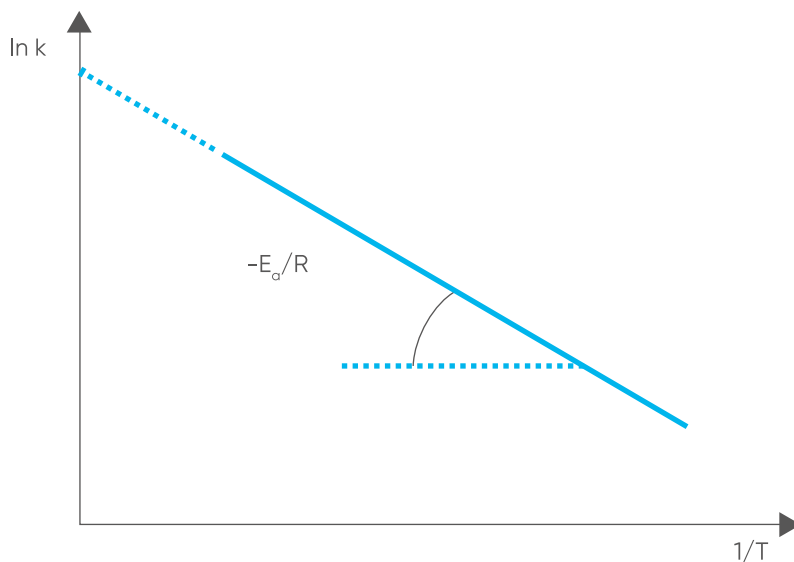

Therefore, it is necessary to know the behaviour of thermoplastic materials to the action of chemical compounds in order to make a precise selection that leads to the choice of the most suitable material.

By summarizing the information on every single plastic material it is possible to notice that, for example, PVC is suitable with most strong acids, alkalis, aqueous solutions, aliphatic hydrocarbons and fluorides, but it is generally not recommended with esters, ketones, ethers and aromatic or chlorinated hydrocarbons.

CPVC is the one between plastic materials with the most interesting features, due to its resistance to corrosive chemicals, the same chemicals that can degrade and shorten the life of several metals, such as sulfuric and hydrochloric acid, sulphate and hydroxides.

Additionally, CPVC is not pH limited, but can accommodate large swings in pH of fluids it carries.

Therefore, it is used in a wide range of industrial operations, like plating of metals, chlor-alkali industry or the treatment of wastewater.

Polyolefins are resistant to aqueous solutions of salts, dilute acids, alkalis and electrochemical processes which can lead to corrosion in metals.

Only strong oxidizing agents such as highly concentrated peroxides and acids or halogens attack the material over a prolonged period of time.

PVDF tolerates most inorganic acids and salts, organic acids, aliphatic and aromatic hydrocarbons, crude oil and fuels, alcohols and ethers, halogens, with the exception of fluorine.

ABS is resistant to aqueous acids, alkalis, concentrated hydrochloric and phosphoric acids, but it can be attacked by concentrated sulfuric and nitric acids. It is soluble in esters, ketones, and ethylene dichloride.

FKM and FFKM are fluorinated elastomers, the absolute reference for rubber seals in terms of chemical resistance. They are used in high technology applications, for example in the aerospace field, in military applications, for the manufacture of polymeric optical fibers, or in piping systems for particularly aggressive environments, such as the atmospheres of oxygen, fluorine, hydrogen, hydrogen sulphide and acids.

Compared to common rubbers, they have a high resistance to attack by chemical agents, ultraviolet rays and oxidants.

Another elastomer that is one of the most popular types of synthetic rubber is EPDM, which has a very good resistance to atmospheric oxidation, so to ozone, to water-based chemicals and also to acids and alkalis.

Even if at first glance to choose the material based on the chemical resistance of the transported fluid may seem trivial, actually it is a very complicated and selective procedure, since, as can be seen in the table, it is difficult to find a material that can adapt to more fluids.

Since temperature greatly affects the chemical resistance of a material, this table should only be considered as a generic, non-specific example.

To get a detailed and safe analysis it is advisable to consult the chemical resistance database on Aliaxis website.

Chemical	PVC-U	PVC-C	ABS	PE	PP	PVDF	EPDM	FKM
Chlorine gas, pure (dry)	Conditional	Conditional	X	X	X	Conditional	X	√
Chlorine gas (wet)	Conditional	Conditional	X	X	X	Conditional	X	Conditional
Chlorine Water, saturated	√	√	X	Conditional	X	Conditional	√	√
Liquid chlorine (gas)	X	X	X	X	X	Conditional	X	√
Sodium hypochlorite (12.5%)	√	√	X	Conditional	Conditional	Conditional	Conditional	√
Chloraminated water	√	√	X	Conditional	√	√	√	√
Chlorine Dioxide, saturated	√	√	X	X	Conditional	Conditional	X	√
Ozone (aqueous)	√	√	X	Conditional	Conditional	√	√	√
Ozone (gas)	Conditional	Conditional	X	X	X	Conditional	√	√

Therefore, to get a general view of the topic and a more precise list of chemicals with which plastic materials can interact, it is suggested to examine the industrial chemical resistance guides available on Aliaxis website or within easy reach on Aliaxis app. These tabulate the classes of chemical resistance of thermoplastic and elastomeric materials most commonly used for the production of valves and fittings used to convey industrial fluids.

The listed data are based on industrial experience and laboratory immersion test results.

Other authoritative sources on chemical resistance are two widely accepted standards:

- ISO 10358.
- DIBt Media List 40.

As said before, variations in the composition of the chemical compounds or in the operating conditions, such as pressure and temperature as well as mechanical stress, can significantly modify the actual chemical resistance of the materials: in laboratory test pure medium has been adopted, but it is necessary to remember that chemical resistance is affected and frequently reduced when handling a number of chemicals or compounds containing impurities.

Therefore, when specific applications are considered, it is often worthwhile to conduct tests using the actual mix fluid that will be used in service.

According to the chemical resistance guide, three different classes of chemical resistance degree are conventionally used:

- class 1: high resistant material. The materials belonging to this class are completely resistant against the conveyed fluid according to the specified operating conditions;
- class 2: limitedly resistant materials. The materials belonging to this class are partially attacked by the conveyed chemical compound. The average life of the material is therefore shorter, and it is advisable to use a higher safety factor the one adopted for Class 1 materials;
- class 3: not resistant materials. All materials belonging to this class are subject to corrosion by the conveyed fluid and they should therefore not be used.

In this way, just by searching for the plastic material and the industrial fluid desired, it is possible to understand if the resistance is good or not.

To conclude the topic about chemical resistance, it is necessary to consider, in addition to the chemical and mechanical properties of pipes and fittings, also the integrity of the joint, which is often the most vulnerable point of an industrial system.

Actually, pipe joints have shown to be very resistant when using applications such as butt and solvent welding or electrofusion that create homogeneous joints.

In particular, the solvent welding is an installation process that uses solvents and plastic resins to chemically fuse the pipe and fitting together.

When applied, the solvent softens and dissolves the top layer of the pipe and fitting material, by loosening their molecular structure, creating a continuous piece of thermoplastic material.

In this case the joints with the solvent cement maintain the same chemical resistance as the plastic, because it is precisely the same material and not a glue or a foreign component added to the piece. Moreover, since the resin in the solvent cement fills any spaces that might otherwise exist in the joint, the chemical resistance is often high.



Signs of chemical aggression occurred since a thermoplastic material not suitable for the transported fluid was chosen.

2.4 Dimensioning and hydraulic engineering

This section sets some engineering requirements for the safe design of pipes made of several materials, such as UPVC, CPVC, PVDF, ABS, PP-H, PE100, carrying water or non hazardous fluids.

2.4.1 Pipe design

The first step in designing a piping system is to decide what diameter sizes to use.

To do this, it is essential to understand and study several factors, some of which are directly linked to pressure:

- design stress;
- nominal pressure;
- standard dimension ratio (SDR);
- series;
- wall thickness.

2.4.1.1 Calculation of design stress based on MRS classification

The largest stress present in any piping system under pressure is hoop stress, defined as the force exerted circumferentially, perpendicular to the axis and the radius of the object, in both directions on every particle in the cylinder wall.

This is the governing factor in determining the pressure that a section of pipe can withstand and it is usually called as design stress, indicated by σ .

It can be calculated by the following equation:

$$\sigma = \frac{MRS}{C}$$

where:

σ = design stress (MPa)

MRS=Minimum required stress (MPa), so the minimum guaranteed value of the breaking load of material at a temperature of 20°C and for 50 years of continuous service.

C=design coefficient (-)

In some cases additional factors may be required, usually depending on chemical, on material and temperature or on joining method, as described in the following table from DVS 2205.

Material	Chemical factor	Toughness factor	Long-Term Joint factor
UPVC	Chemical dependent	Material and temperature dependent	Joining method dependent
CPVC (pipe)			
CPVC (fitting)			
ABS			
PPH			
PE 100			
PVDF			

In this way the previous equation of design stress changes into a new one:

$$\sigma = \frac{MRS * F_j}{(C * F_c * F_t)}$$

where:

σ = design stress (MPa)

MRS= minimum required stress (MPa)

C= design coefficient (-)

F_j= long term joint factor (-)

F_c= chemical factor (-)

F_t= toughness factor (-)

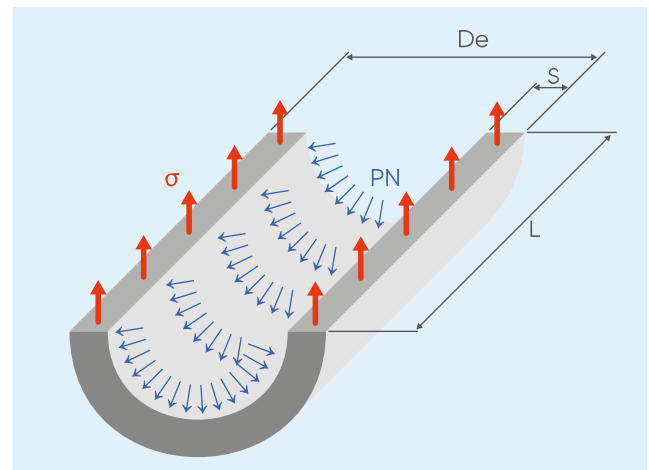

According to strength curves described in ISO 15494, ISO 15493 and ISO 10931, the value of hoop stress can be found for every material at different pressure and years of service life.

As regards the design coefficient, different values are used depending on which material the pipe is made of and on which standard you refer to: the following table shows different minimum values of design coefficient (C_{min}) listed on DIN Standard, DIBt Approval and EN ISO 12162.

In particular, while DIN is a National Standard and EN an European Standard, DIBt Approval is given by DIBt (Deutsches Institut für Bautechnik).

This is a German government agency that issues statements affirming that products under consideration meet German safety and regulatory requirements.

Material	DIN Standards	DIBt Approval	ISO 12162
UPVC	2 – 2.5	2	1.6
CPVC	-	2	1.6
ABS	-	2	1.6
PPH	1.6 (10-40 °C) 1.4 (40-60 °C) 1.25 (<60 °C)	2	1.6
PE100	1.25 -1.6 -2	2	1.25
PVDF	-	2	1.6

In particular EN ISO 12162 is based on tests made on tubular shapes and gives values of C_{min} useful to calculate the permissible pressure that can be applied in the system.

On the other hand, the nominal pressure, so the operative one, must be calculated by using an industrial and manufacturer coefficients (C) suggested from each manufacturing company.

Since these industrial coefficients C for safety reasons are higher than C_{min} listed on EN ISO 12162, the operative pressure is always slightly lower than the permissible one.

2.4.1.2 Calculation of nominal pressure

For plastic piping systems intended to transport water, the nominal pressure describes the maximum working pressure in bar at a temperature of 20 °C and for 50 years of service life.

For pipes carrying other industrial fluids nominal pressure is referred to 25 years of service life.

It can be expressed as:

$$PN = 20 * \frac{\sigma}{(SDR - 1)}$$

where:

PN = nominal pressure (bar)

σ = design stress (MPa)

SDR = standard dimension ratio (-) described below

As said before, it is important to remember that the design stress σ for the nominal pressure is calculated by industrial design coefficient C given by our company, commonly adopted in industrial application.

2.4.1.3 Calculation of standard dimension ratio

The pressure loading capacity of pipes and fittings is expressed as SDR level, Standard Dimension Ratio.

It can be expressed as the relation between the pipe outside diameter and the pipe wall thickness.

$$SDR = \frac{De}{t}$$

where:

SDR= Standard Dimension Ratio (-)

De= external diameter (mm)

t= wall thickness (mm)

According to nominal pressure, SDR can be calculated also by:

$$SDR = \frac{(20 * \sigma)}{PN + 1}$$

where:

SDR= Standard Dimension Ratio (-)

σ = design stress (MPa)

PN = nominal pressure (bar)

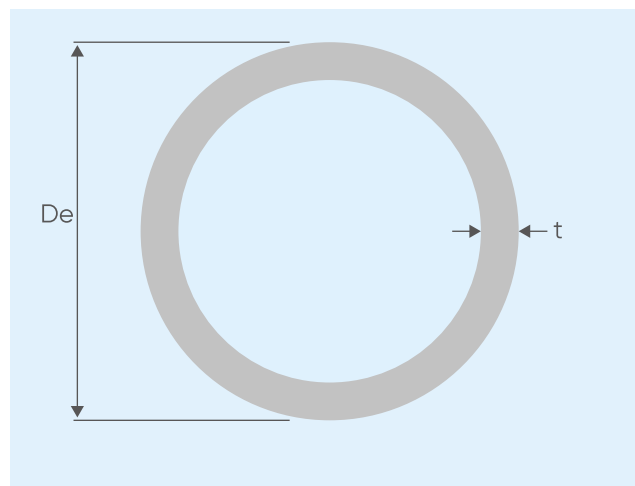

PRACTICAL EXAMPLE

Calculate SDR value if De=110 mm and t=10 mm

$$SDR = \frac{De}{t} = \frac{110}{10} = 11$$

2.4.1.4 Calculation of series

ISO 4065 classifies pipe by series according to pressure rating, so pipes with the same series number have the same pressure rating.

The pipe series are denoted by the letter S and can be calculated by the following equation:

$$S = \frac{(SDR-1)}{2}$$

where:

SDR = standard dimension ratio (-)

S = pipe series (-)

PRACTICAL EXAMPLE

Calculate series for SDR 11

$$S = \frac{(11-1)}{2} = 5$$

2.4.1.5 Calculation of wall thickness

The sizing of the thermoplastic pipe subjected to internal pressure is related to the strength requirements.

All tube sizes found in the standards are based on this formula:

$$t = \frac{(De * PN)}{(20 * \sigma + PN)}$$

where:

t = thickness of the wall (mm)

De = external diameter of the pipe (mm)

σ = design stress (MPa)

PN = nominal pressure (bar)

In the following tables wall thickness of every material according to external diameters and SDR values is shown.

UPVC							
S	20	16	12.5	10	8	6.3	5
SDR	41	33	26	21	17	13.6	11
De (mm)	t (mm)						
12	-	-	-	-	-	-	1.5
16	-	-	-	-	-	-	1.5
20	-	-	-	-	-	1.5	1.9
25	-	-	-	-	1.5	1.9	2.3
32	-	-	1.5	1.6	1.9	2.4	2.9
40	-	1.5	1.6	1.9	2.4	3	3.7
50	-	1.6	2	2.4	3	3.7	4.6
63	-	2	2.5	3	3.8	4.7	5.8
75	-	2.3	2.9	3.6	4.5	5.6	6.8
90	-	2.8	3.5	4.3	5.4	6.7	8.2
110	2.7	3.4	4.2	5.3	6.6	8.1	10
125	3.1	3.9	4.8	6	7.4	9.2	11.4
140	3.5	4.3	5.4	6.7	8.3	10.3	12.7
160	4	4.9	6.2	7.7	9.5	11.8	14.6
180	4.4	5.5	6.9	8.6	10.7	13.3	16.4
200	4.9	6.2	7.7	9.6	11.9	14.7	18.2
225	5.5	6.9	8.6	10.8	13.4	16.6	-
250	6.2	7.7	9.6	11.9	14.8	18.4	-
280	6.9	8.6	10.7	13.4	16.6	20.6	-
315	7.7	9.7	12.1	15	18.7	23.2	-
355	8.7	10.9	13.6	16.9	21.1	26.1	-
400	9.8	12.3	15.3	19.1	23.7	29.4	-

CPVC				
S	10	6.3	5	4
SDR	21	13.6	11	9
De (mm)	t (mm)			
12	-	1.4	1.4	1.4
16	-	1.4	1.5	1.8
20	-	1.5	1.9	2.3
25	-	1.9	2.3	2.8
32	1.6	2.4	2.9	3.6
40	1.9	3	3.7	4.5
50	2.4	3.7	4.6	5.6
63	3	4.7	5.8	7.1
75	3.6	5.6	6.8	8.4
90	4.3	6.7	8.2	10.1
110	5.3	8.1	10	12.3
125	6	9.2	11.4	14
140	6.7	10.3	12.7	15.7
160	7.7	11.8	14.6	17.9
180	8.6	13.3	-	-
200	9.6	14.7	-	-
225	10.8	16.6	-	-

ABS								
S	20	16	12.5	10	8	6.3	5	4
SDR	41	33	26	21	17	13.6	11	9
De (mm)	t (mm)							
12	-	-	-	-	-	-	1.5	1.5
16	-	-	-	-	-	1.5	1.5	1.8
20	-	-	-	-	-	1.5	1.9	2.3
25	-	-	-	-	1.5	1.9	2.3	2.8
32	-	-	-	1.6	1.9	2.4	2.9	3.6
40	-	-	1.6	1.9	2.4	3	3.7	4.5
50	-	1.6	2	2.4	3	3.7	4.6	5.6
63	1.6	2	2.5	3	3.8	4.7	5.8	7.1
75	1.9	2.3	2.9	3.6	4.5	5.6	6.8	8.4
90	2.2	2.8	3.5	4.3	5.4	6.7	8.2	10.1
110	2.7	3.4	4.2	5.3	6.6	8.1	10	12.3
125	3.1	3.9	4.8	6	7.4	9.2	11.4	14
140	3.5	4.3	5.4	6.7	8.3	10.3	12.7	15.7
160	4	4.9	6.2	7.7	9.5	11.8	14.6	17.9
180	4.4	5.5	6.9	8.6	10.7	13.3	16.4	20.1
200	4.9	6.2	7.7	9.6	11.9	14.7	18.2	22.4
225	5.5	6.9	8.6	10.8	13.4	16.6	20.5	25.2
250	6.2	7.7	9.6	11.9	14.8	18.4	22.7	27.9
280	6.9	8.6	10.7	13.4	16.6	20.6	25.4	31.3
315	7.7	9.7	12.1	15	18.7	23.2	28.6	35.2
355	8.7	10.9	13.6	16.9	21.1	26.1	32.2	39.7
400	9.8	12.3	15.3	19.1	23.7	29.4	36.3	44.7

PP							
S	20	16	12.5	8.3	5	3.2	2.5
SDR	41	33	26	17.6	11	7.4	6
De (mm)	t (mm)						
12	-	-	-	-	1.8	1.8	2
16	-	-	-	-	1.8	2.2	2.7
20	-	-	-	1.8	1.9	2.8	3.4
25	-	-	-	1.8	2.3	3.5	4.2
32	-	-	-	1.9	2.9	4.4	5.4
40	-	-	1.8	2.3	3.7	5.5	6.7
50	1.8	1.8	2	2.9	4.6	6.9	8.3
63	1.8	2	2.5	3.6	5.8	8.6	10.5
75	1.9	2.3	2.9	4.3	6.8	10.3	12.5
90	2.2	2.8	3.5	5.1	8.2	12.3	15
110	2.7	3.4	4.2	6.3	10	15.1	18.3
125	3.1	3.9	4.8	7.1	11.4	17.1	20.8
140	3.5	4.3	5.4	8	12.7	19.2	23.3
160	4	4.9	6.2	9.1	14.6	21.9	26.6
180	4.4	5.5	6.9	10.2	16.4	24.6	29.9
200	4.9	6.2	7.7	11.4	18.2	27.4	33.2
225	5.5	6.9	8.6	12.8	20.5	30.8	37.4
250	6.2	7.7	9.6	14.2	22.7	34.2	-
280	6.9	8.6	10.7	15.9	25.4	38.3	-
315	7.7	9.7	12.1	17.9	28.6	43.1	-
355	8.7	10.9	13.6	20.1	32.2	48.5	-
400	9.8	12.3	15.3	22.7	36.3	54.7	-
450	11	13.8	17.2	25.5	40.9	-	-
500	12.3	15.3	19.1	28.3	45.4	-	-
560	13.7	17.2	21.4	31.7	50.8	-	-
630	15.4	19.3	24.1	35.7	-	-	-
710	17.4	21.8	27.2	40.2	-	-	-
800	19.6	24.5	30.6	45.3	-	-	-
900	22	27.6	34.4	51	-	-	-
1000	24.5	30.6	38.2	-	-	-	-
1200	29.4	36.7	45.9	-	-	-	-
1400	34.3	42.9	53.5	-	-	-	-
1600	39.2	49	61.2	-	-	-	-

PE							
S	20	16	12.5	8	5	3.2	2.5
SDR	41	33	26	17	11	7.4	6
De (mm)	t (mm)						
16	-	-	-	-	1.8	2.2	2.7
20	-	-	-	1.8	1.9	2.8	3.4
25	-	-	-	1.8	2.3	3.5	4.2
32	-	-	-	1.9	2.9	4.4	5.4
40	-	-	1.8	2.4	3.7	5.5	6.7
50	1.8	1.8	2	3	4.6	6.9	8.3
63	1.8	2	2.5	3.8	5.8	8.6	10.5
75	1.9	2.3	2.9	4.5	6.8	10.3	12.5
90	2.2	2.8	3.5	5.4	8.2	12.3	15
110	2.7	3.4	4.2	6.6	10	15.1	18.3
125	3.1	3.9	4.8	7.4	11.4	17.1	20.8
140	3.5	4.3	5.4	8.3	12.7	19.2	23.3
160	4	4.9	6.2	9.5	14.6	21.9	26.6
180	4.4	5.5	6.9	10.7	16.4	24.6	29.9
200	4.9	6.2	7.7	11.9	18.2	27.4	33.2
225	5.5	6.9	8.6	13.4	20.5	30.8	37.4
250	6.2	7.7	9.6	14.8	22.7	34.2	41.5
280	6.9	8.6	10.7	16.6	25.4	38.3	46.5
315	7.7	9.7	12.1	18.7	28.6	43.1	52.3
355	8.7	10.9	13.6	21.1	32.2	48.5	59
400	9.8	12.3	15.3	23.7	36.3	54.7	-
450	11	13.8	17.2	26.7	40.9	61.5	-
500	12.3	15.3	19.1	29.7	45.4	-	-
560	13.7	17.2	21.4	33.2	50.8	-	-
630	15.4	19.3	24.1	37.4	57.2	-	-
710	17.4	21.8	27.2	42.1	64.5	-	-
800	19.6	24.5	30.6	47.4	72.6	-	-
900	22	27.6	34.4	53.3	81.7	-	-
1000	24.5	30.6	38.2	59.3	90.8	-	-
1200	29.4	36.7	45.9	71.1	-	-	-
1400	34.3	42.9	53.5	83	-	-	-
1600	39.2	49	61.2	94.8	-	-	-
1800	44	55.1	68.8	106.6	-	-	-
2000	48.9	61.2	76.4	118.5	-	-	-
2250	55	68.9	86	-	-	-	-
2500	61.2	76.5	95.5	-	-	-	-

PVDF		
S	16	10
SDR	33	21
De (mm)	t (mm)	
8	-	-
10	-	-
12	-	-
16	-	-
20	-	-
25	-	-
32	-	-
40	-	-
50	-	-
63	2	3
75	2.3	3.6
90	2.8	4.3
110	3.4	5.3
125	3.9	6
140	4.3	6.7
160	4.9	7.7
180	5.5	8.6
200	6.2	9.6
225	6.9	10.8
250	7.7	11.9
280	8.6	13.4
315	9.7	-
355	10.9	-
400	12.3	-

It is necessary to remember that, by considering the same nominal pressure at 20°C and 50 years of service life, at lower SDR a thicker wall can be utilized and at higher SDR a thinner wall.

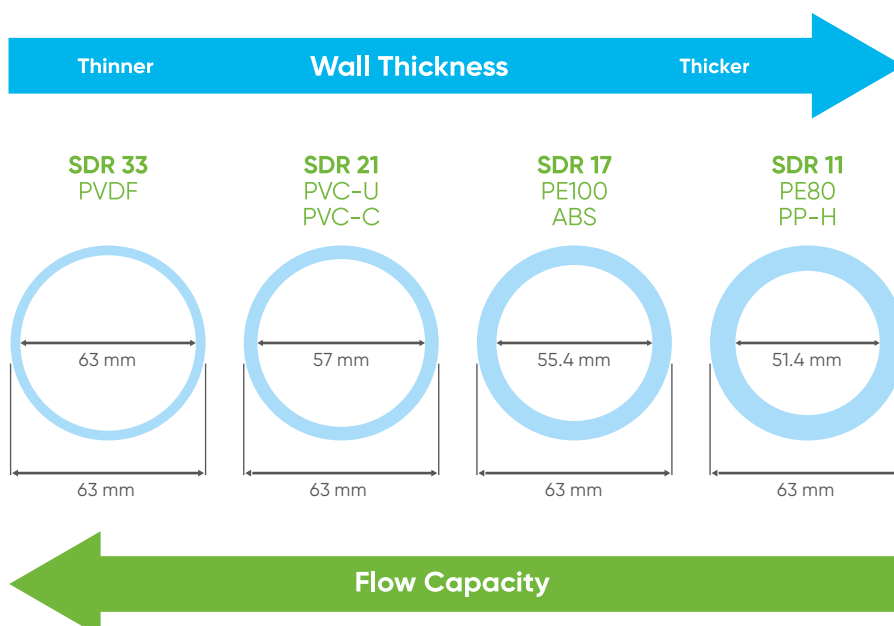

PRACTICAL EXAMPLE

What is the permissible pressure of SDR 17 PE100 pipe conveying water at 20°C?

By looking at strength curve for PE100, at 20°C and 50 years of service life, MRS value is 10 MPa, as shown graphically in the following picture.

According to ISO 12162 C_{min} for PE100 is 1.25.

To get the permissible pressure it is necessary to calculate

$$\sigma = \frac{MRS}{C_{min}} = 8 \text{ MPa}$$

In this way permissible pressure

$$20 * \frac{\sigma}{(SDR-1)} = 10 \text{ bar}$$

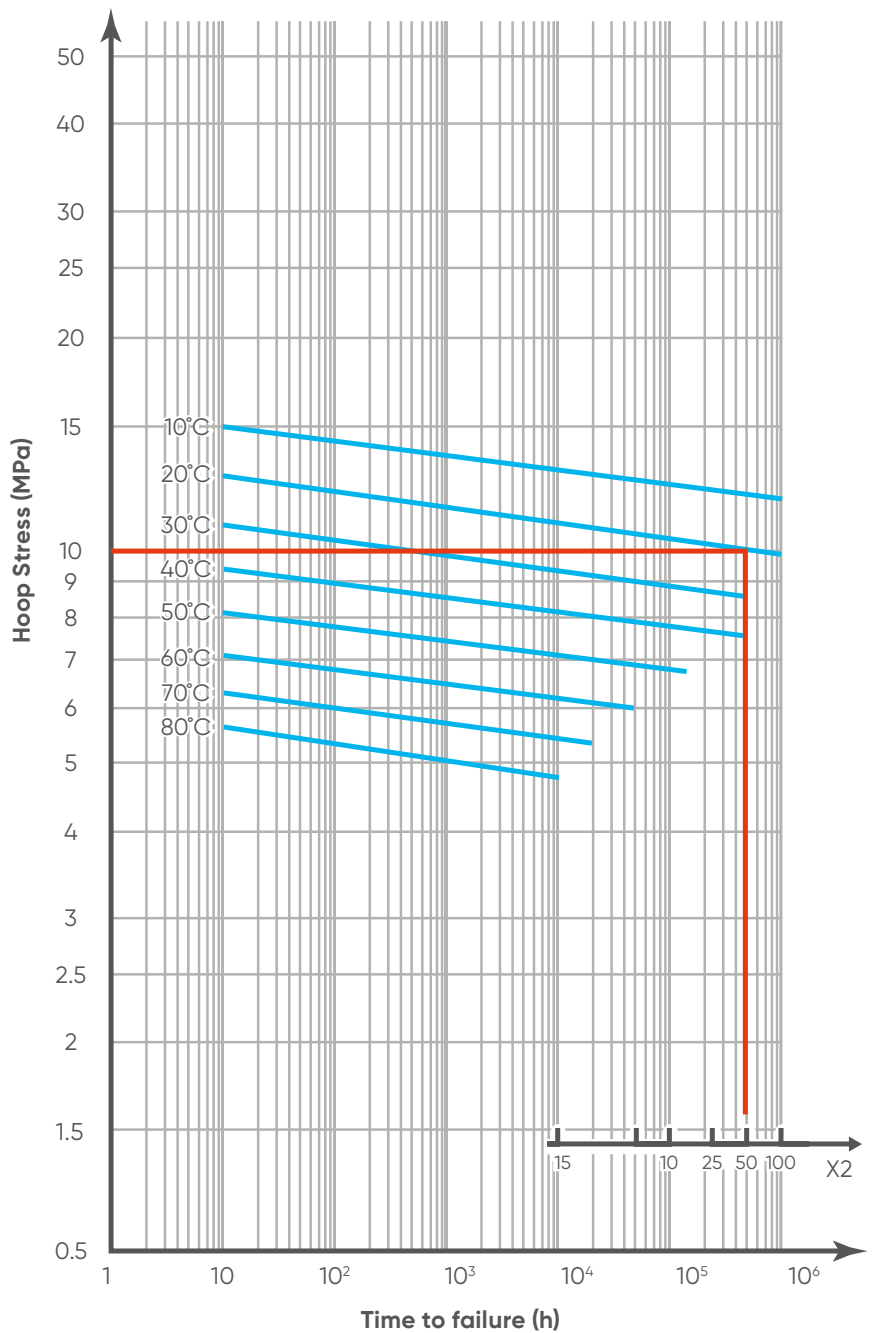

2.4.2 Pressure-Temperature Diagram

As seen in strength curve, the resistance of the thermoplastic material is sensitive to temperature.

Since standard pressure ratings are determined at the ambient temperature of 20 °C, for higher or lower values pressure changes: the relationship between nominal pressure and temperature and permissible pressure and temperature is shown in the following diagrams, one for every material.

It is necessary to notice that they are made for water or non-hazardous fluids, against which the material is considered chemically resistant; in other cases, an adequate decrease of pressure is required.

Aliaxis recommends working below the following curves, not on the edge or above it.

2.4.2.1 Permissible pressure - temperature diagrams

In the previous chapter the difference between the nominal pressure and the permissible pressure, so the maximum pressure allowed, has been explained.

Due to the fact that according to ISO 12162 the minimum design coefficients (Cmin) can be used, an higher theoretical pressure than the nominal one can be applied for specific conditions.

Following diagrams show the permissible pressure value correlated to the temperature according to SDR, minimum design coefficient (Cmin) and service life.

For industrial applications it is always recommended to use the nominal pressure (PN) instead of the permissible pressure.

Permissible pressure-Temperature Diagram for UPVC (25 years)

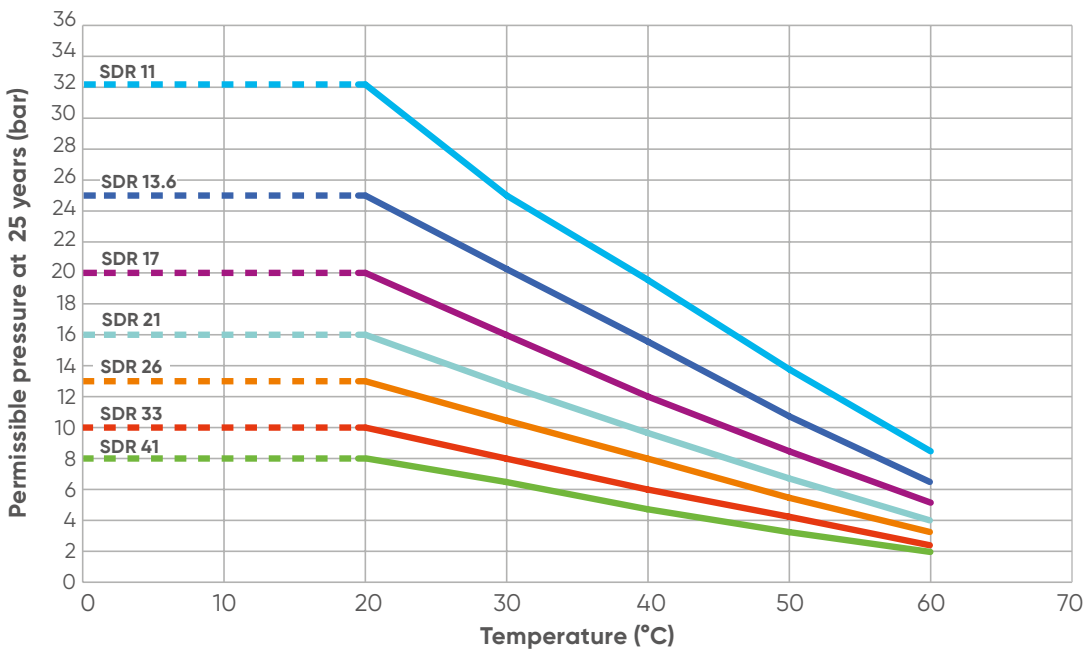

Permissible pressure-Temperature Diagram for UPVC (50 years)

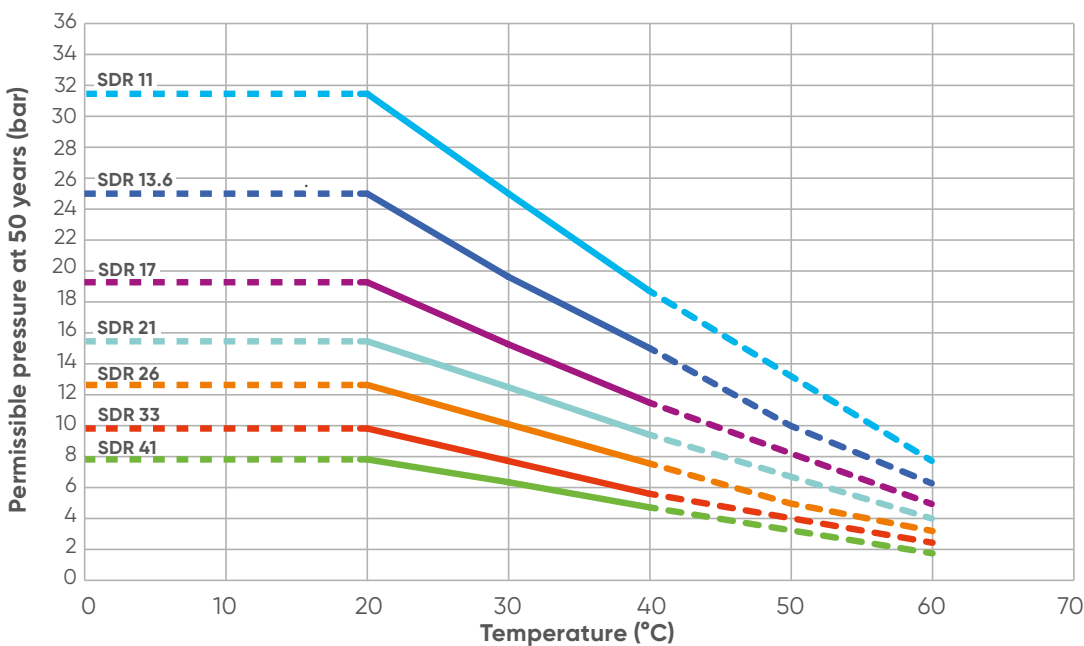

Permissible pressure-Temperature Diagram for CPVC (25 years)

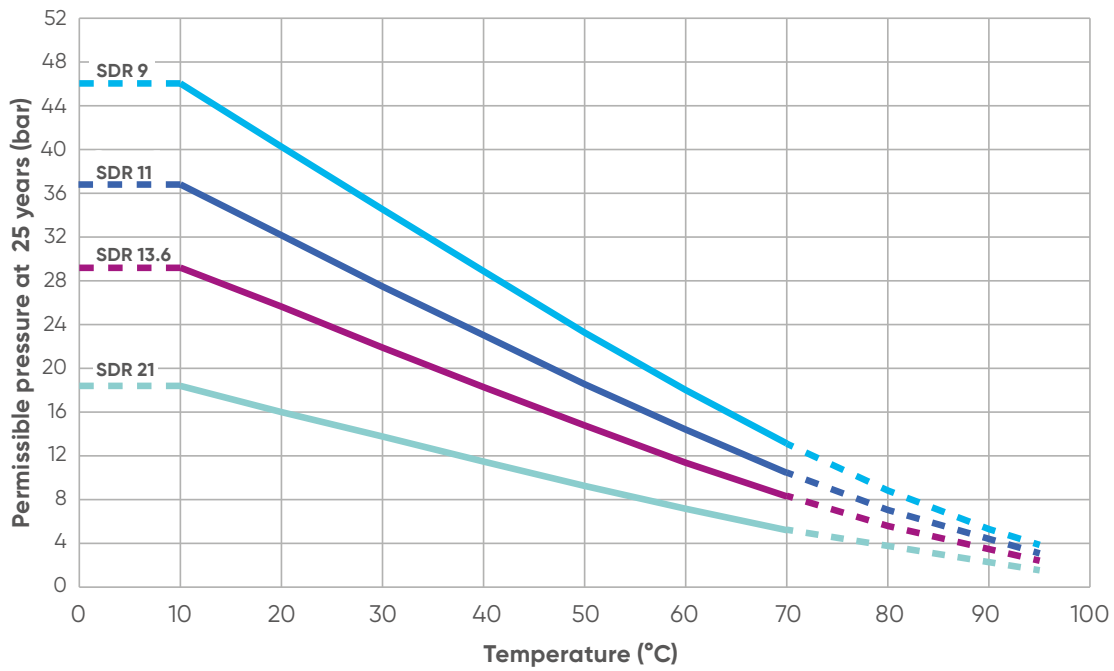

Permissible pressure-Temperature Diagram for CPVC (50 years)

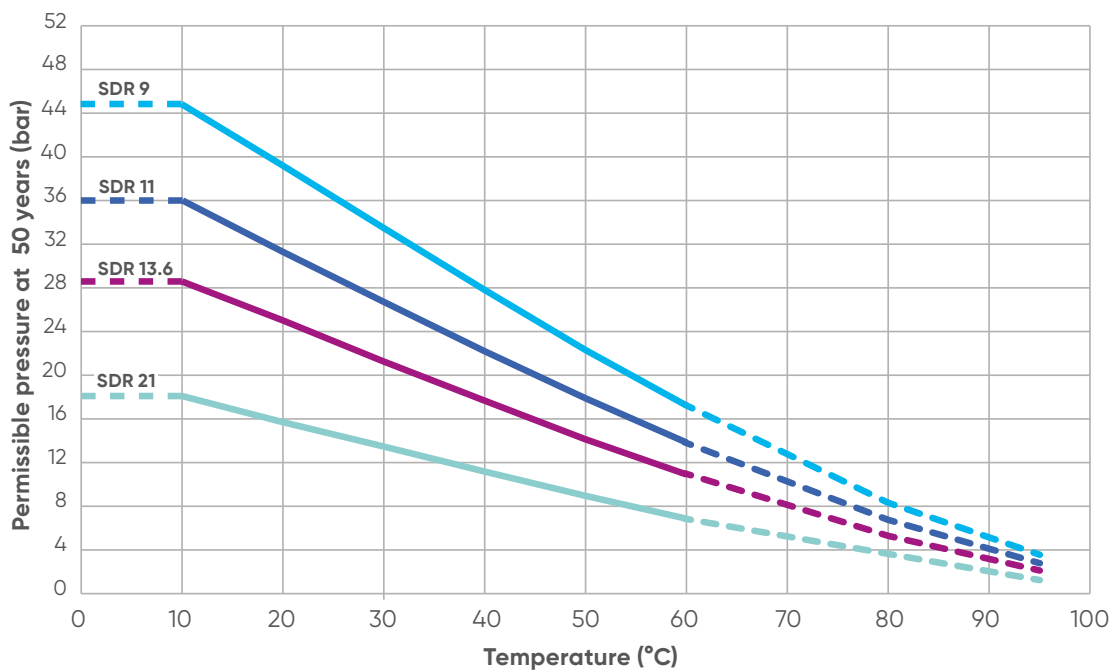

Permissible pressure-Temperature Diagram for ABS (25 years)

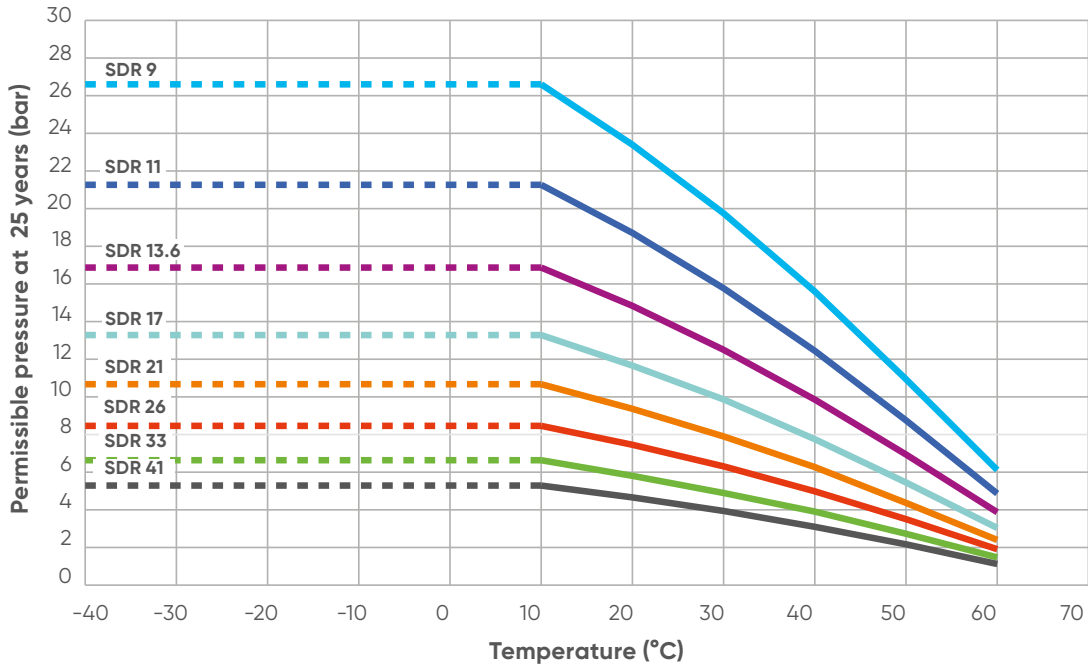

Permissible pressure-Temperature Diagram for ABS (50 years)

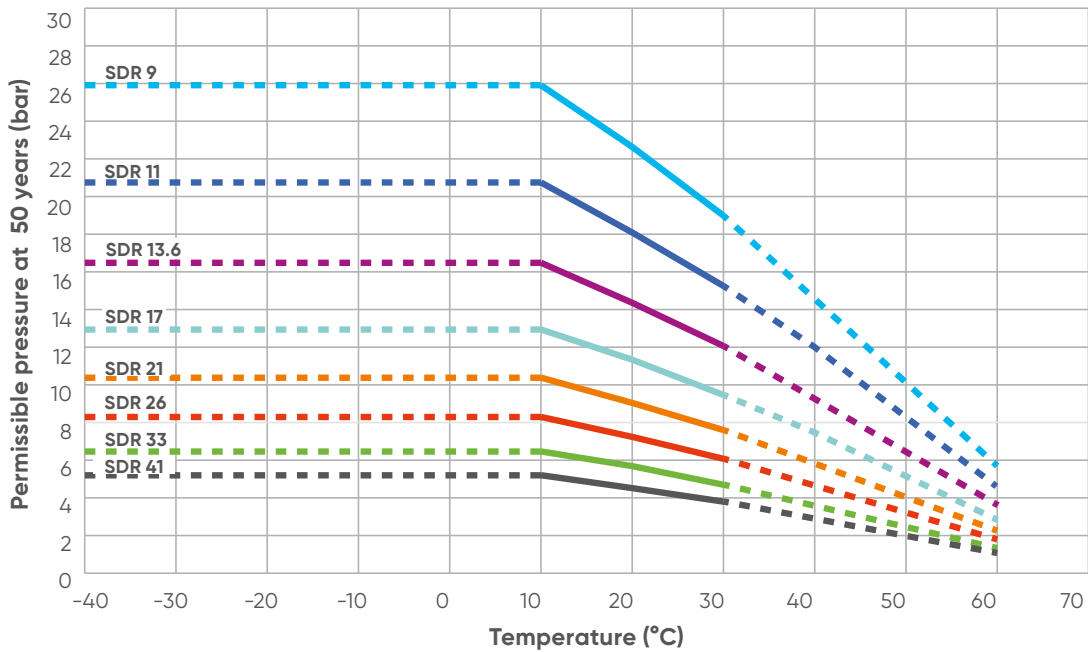

Permissible pressure-Temperature Diagram for PP-H (25 years)

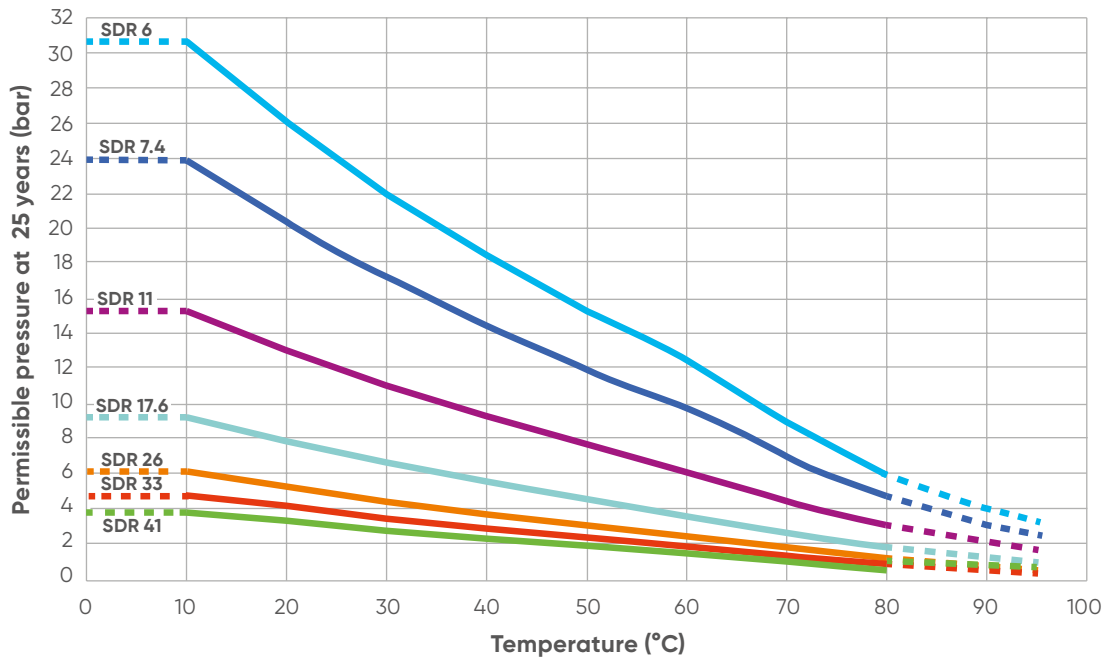

Permissible pressure-Temperature Diagram for PP-H (50 years)

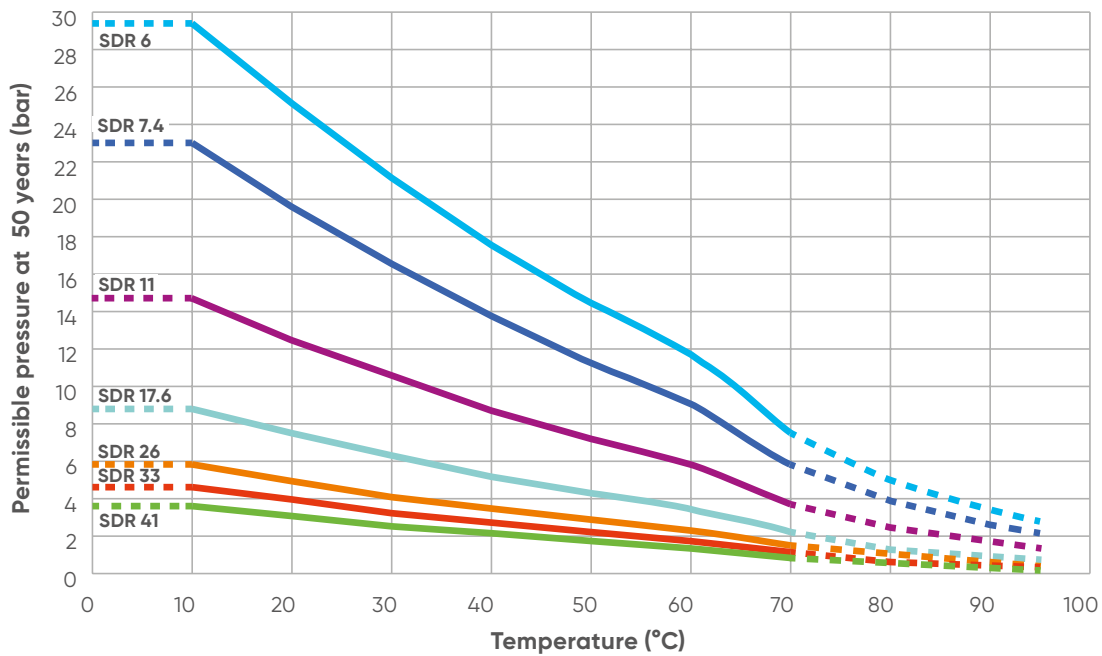

Permissible pressure–Temperature Diagram for PE100 (25 years)

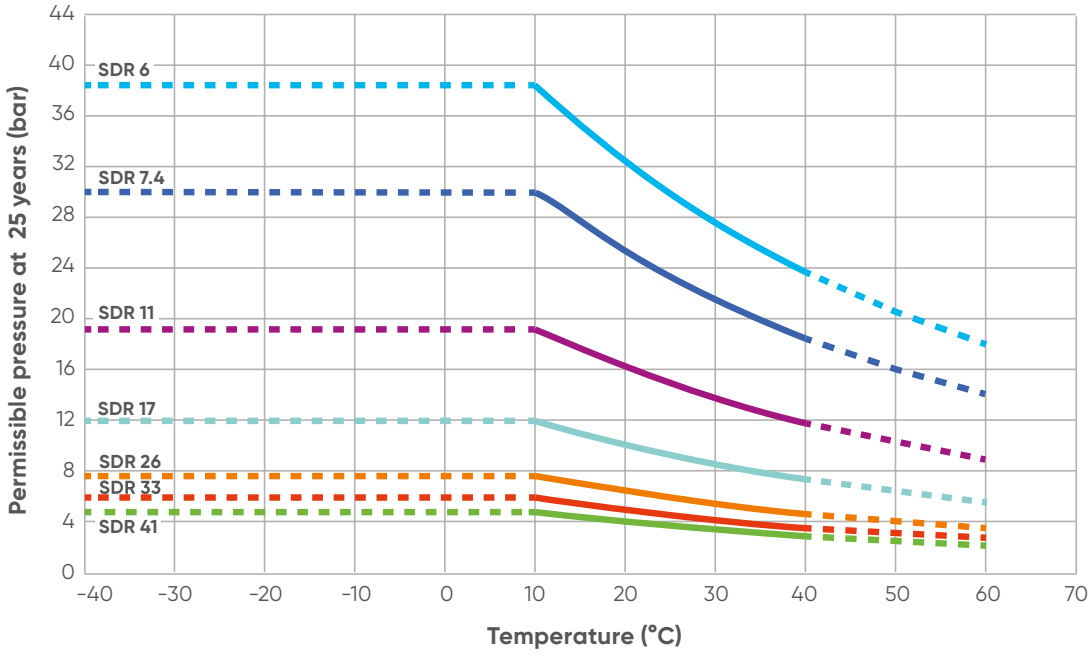

Permissible pressure–Temperature Diagram for PE100 (50 years)

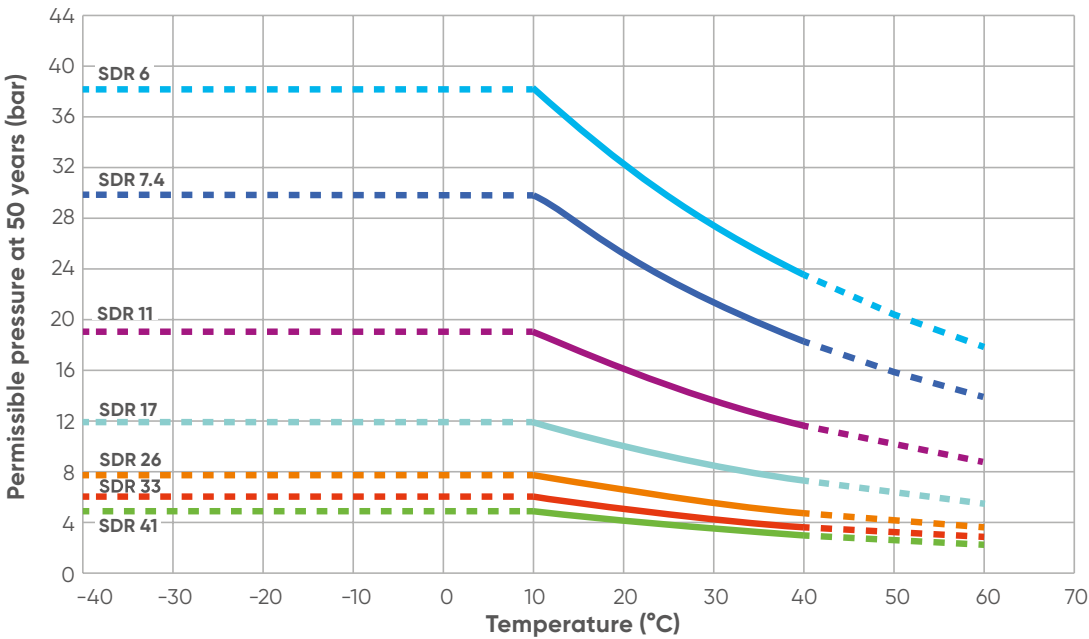

Permissible pressure-Temperature Diagram for PVDF (25 years)

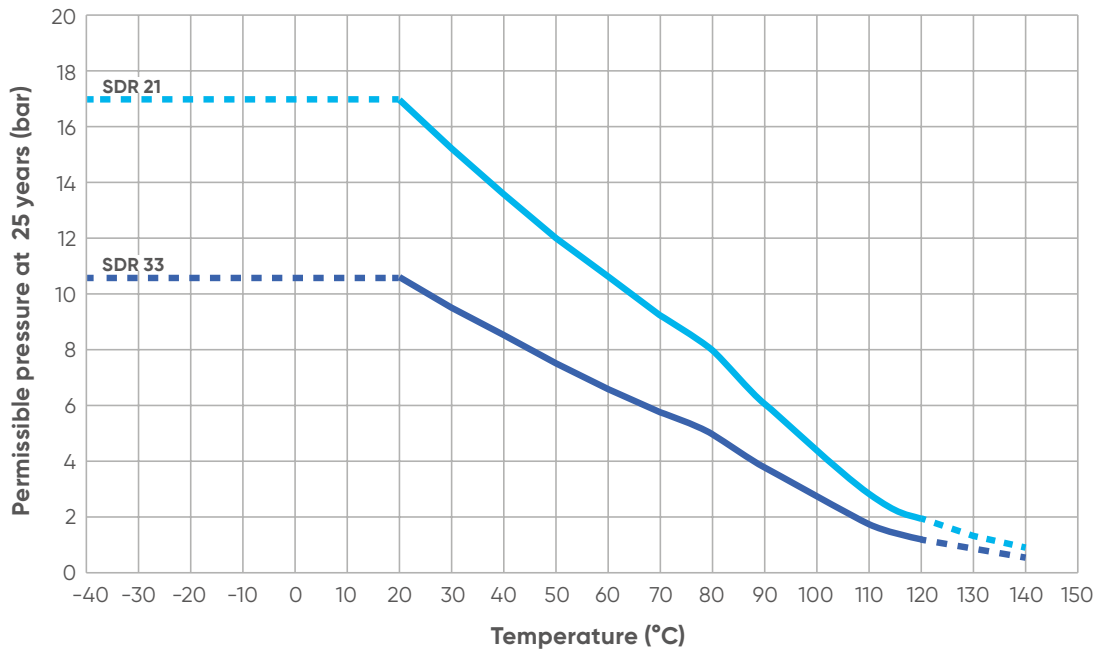

Permissible pressure-Temperature Diagram for PVDF (50 years)

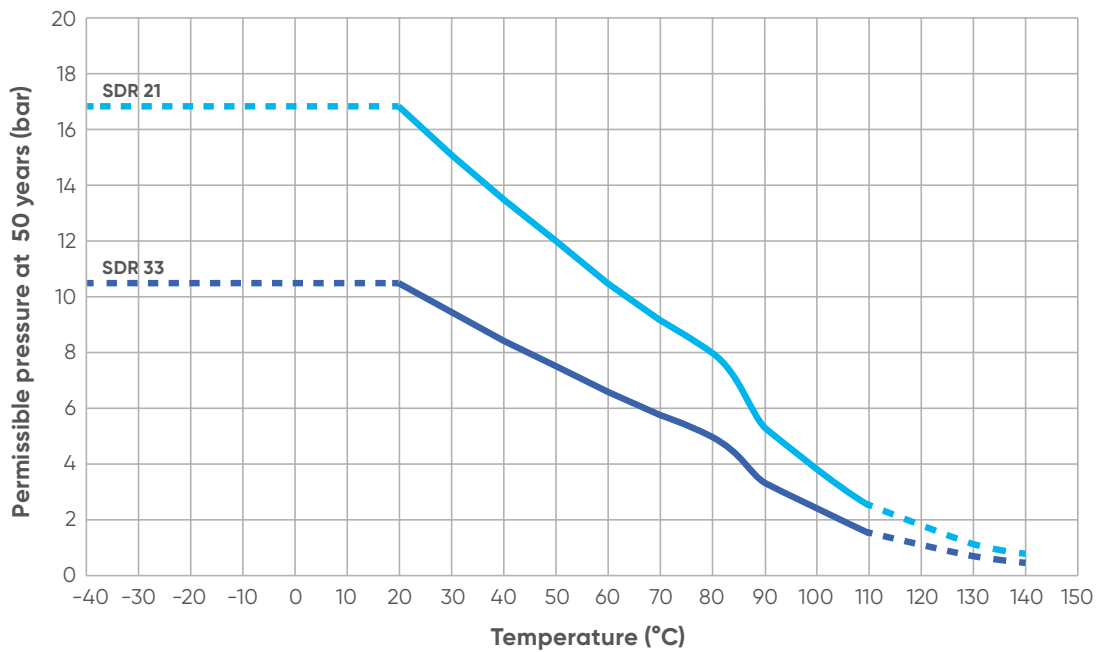

2.4.2.2 Nominal pressure - temperature diagrams

As it is shown, if temperature rises above 20 °C, hoop strength and pressure decrease because MRS values change in strength curves according to temperature.

On the other hand, in the case of operating temperature falling below 20°C nominal pressure maintains its constant value.

As described previously, the nominal pressure is calculated by industrial coefficients C that are suggested from our industrial company.

Since these coefficients for safety reasons are higher than Cmin listed on EN ISO 12162, the operative nominal pressure is always slightly lower than the permissible one.

The following graphs about nominal pressure – temperature should be used for water and non-hazardous fluids for which the material is classified as chemically resistant (life expectancy 25 years). In other cases a reduction of the nominal pressure is required.

For industrial applications the graphs to be referred to are relative to the nominal pressure, shown below.

Nominal pressure-Temperature Diagram for UPVC 25 years

The graph below shows the relationship between nominal pressure and temperature based on the Metric system, according to EN ISO 15493.

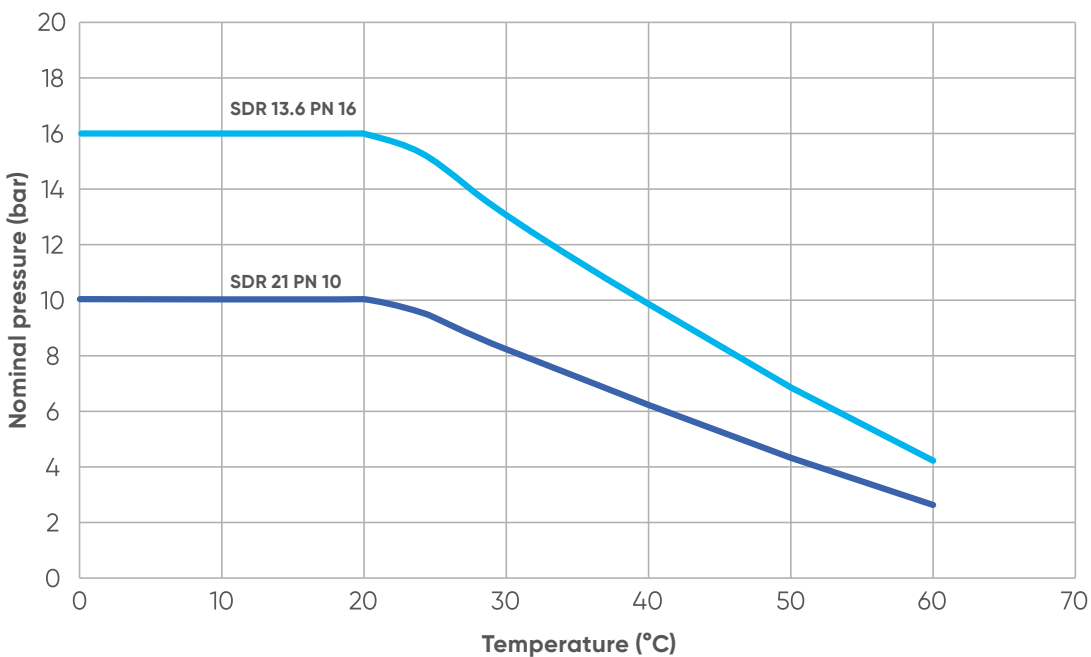

The following graph shows the relationship between pressure and temperature based on the British system, according to BS EN ISO 1452-2.

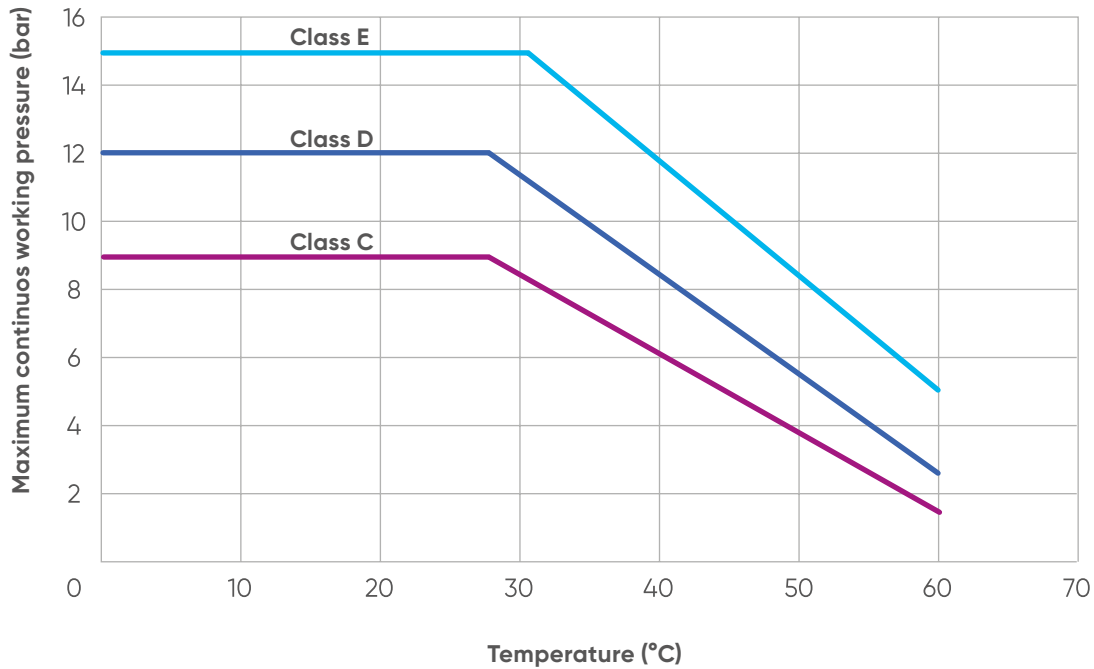

Nominal pressure-Temperature Diagram for CPVC 25 years

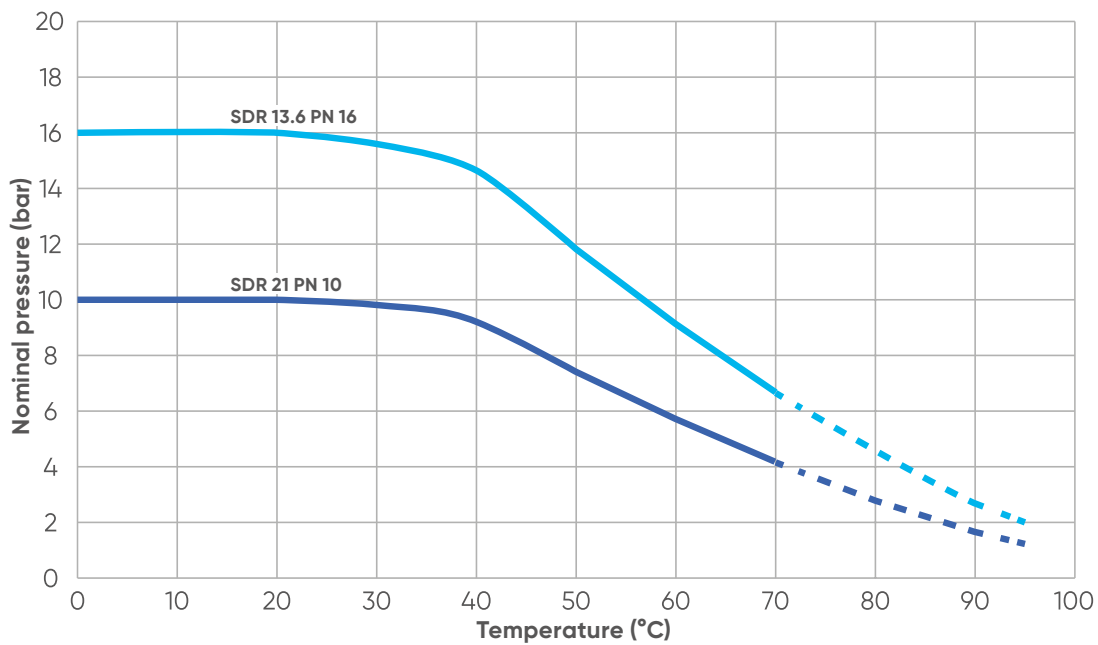

Nominal pressure-Temperature Diagram for ABS 25 years

The graph below shows the relationship between nominal pressure and temperature based on the Metric system, according to EN ISO 15493.

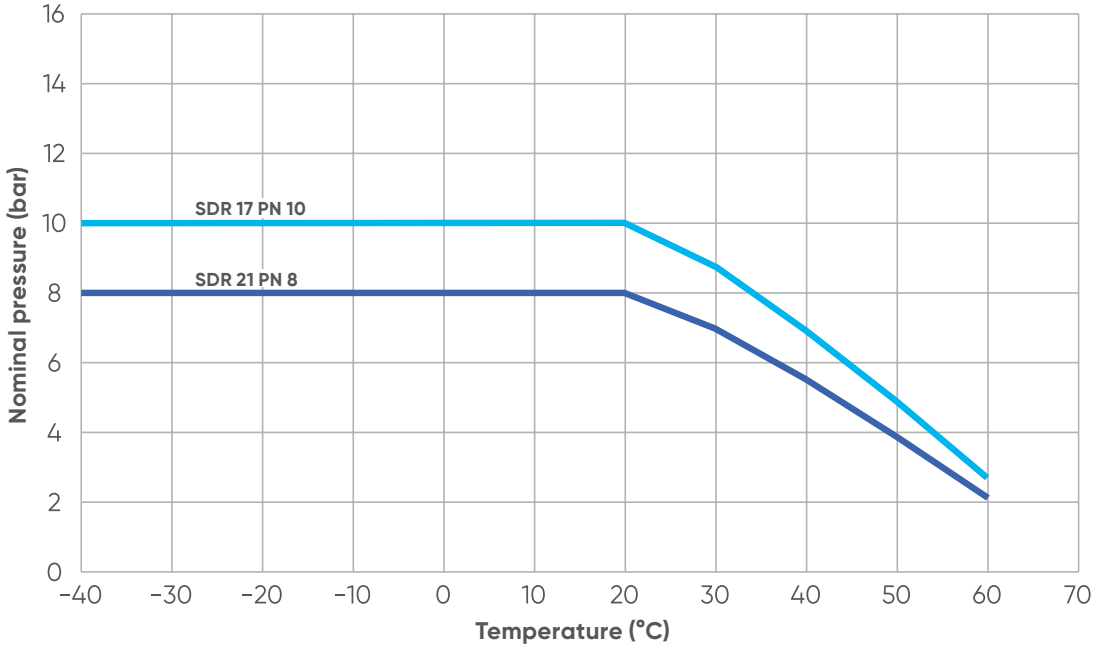

The following graph shows the relationship between pressure and temperature based on the British system, according to BS 5391-1.

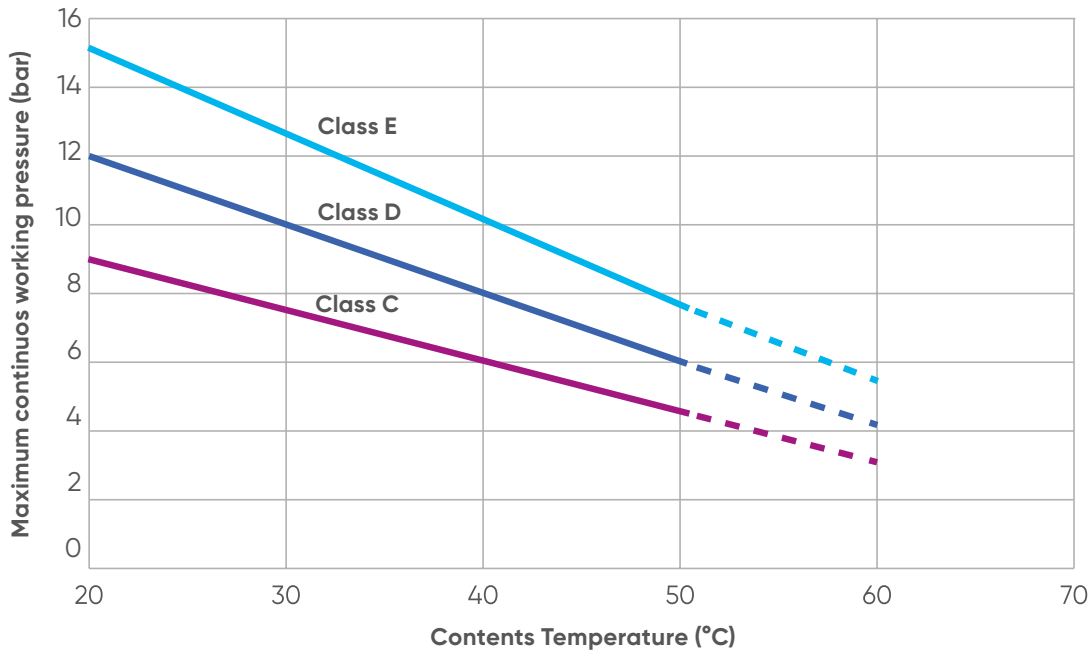

Nominal pressure-Temperature Diagram for PP-H 25 years

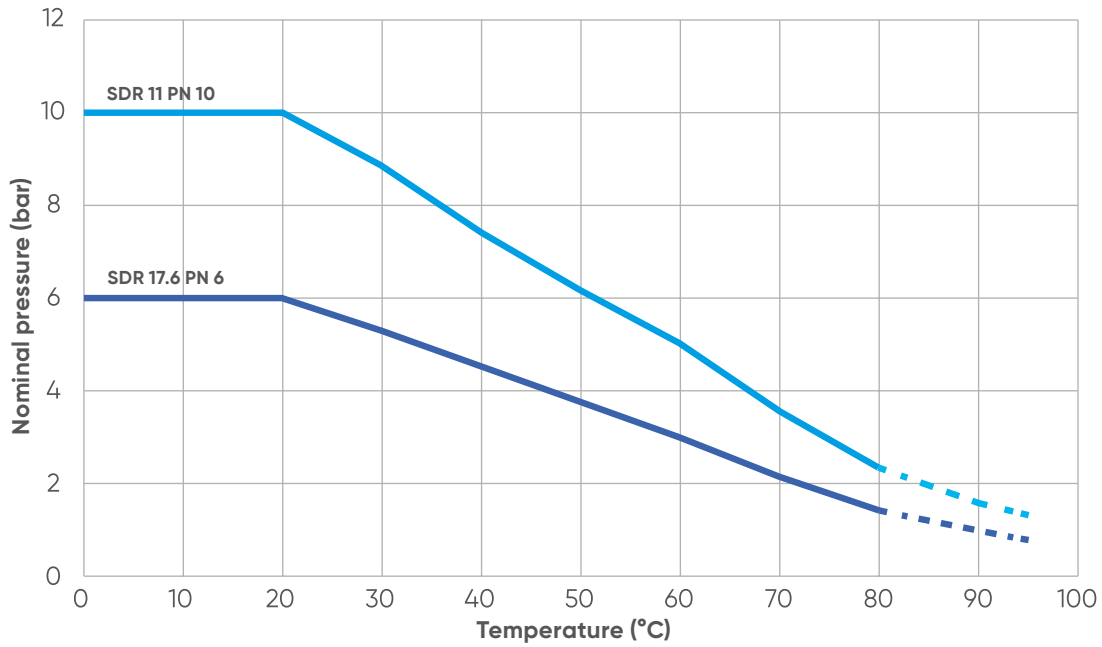

Nominal pressure-Temperature Diagram for PE100 25 years

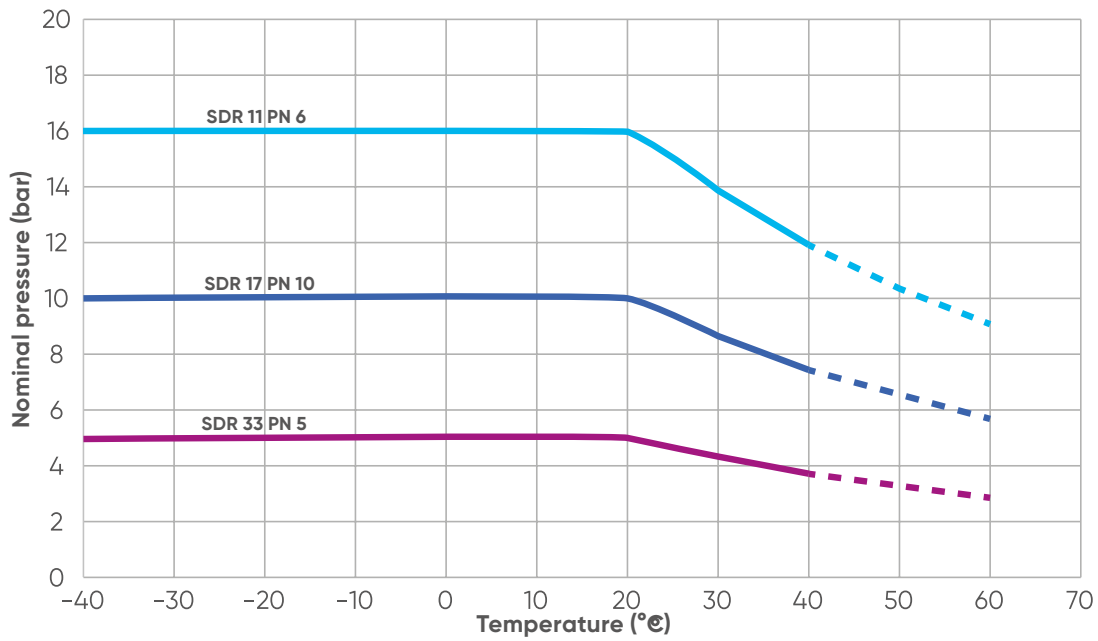

Nominal pressure-Temperature Diagram for PVDF 25 years

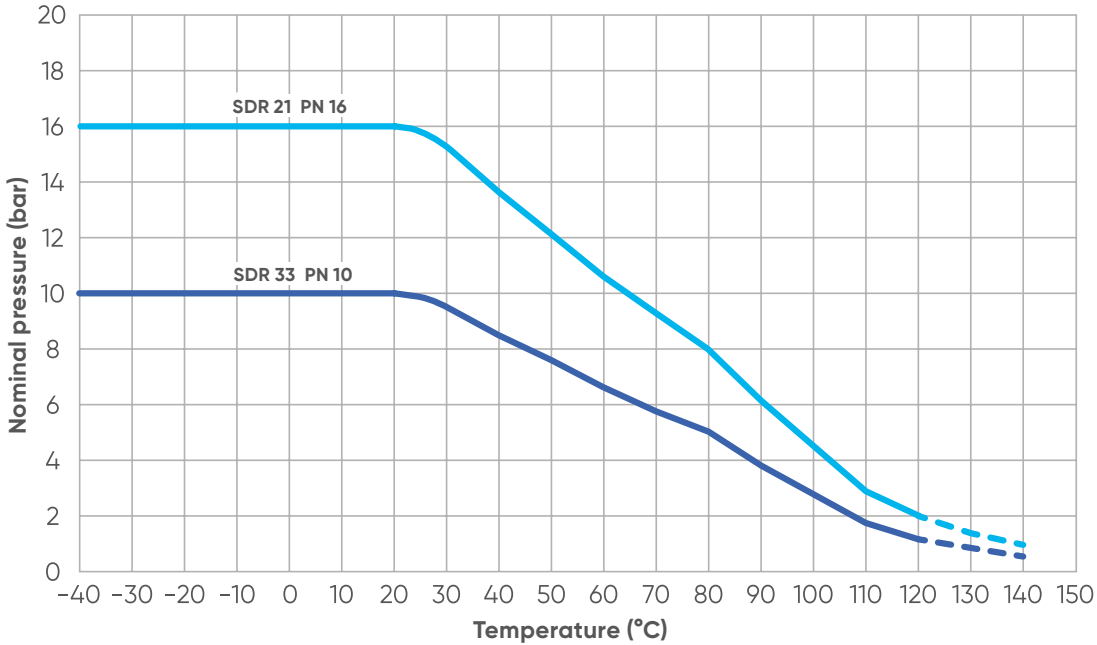

Nominal pressure-Temperature Diagram for valves and fittings

For specific products, such as valves and injected fittings, it is suggested to take into account the pressure-temperature diagrams dedicated to every single product due to the fact that nominal pressure is influenced by typical design characteristics.

For example, the butterfly valve FK made in C-PVC has different nominal diameters depending on the nominal pressure. For wafer version:

- DN 40 ÷ 50: PN 16 with water at 20 °C,
- DN 65 ÷ 250: PN 10 with water at 20 °C,
- DN 300: PN 8 water at 20 °C.

In this way it is possible to have three different lines on the T-P diagram according to the diameters and to the design of the valve as mentioned above.

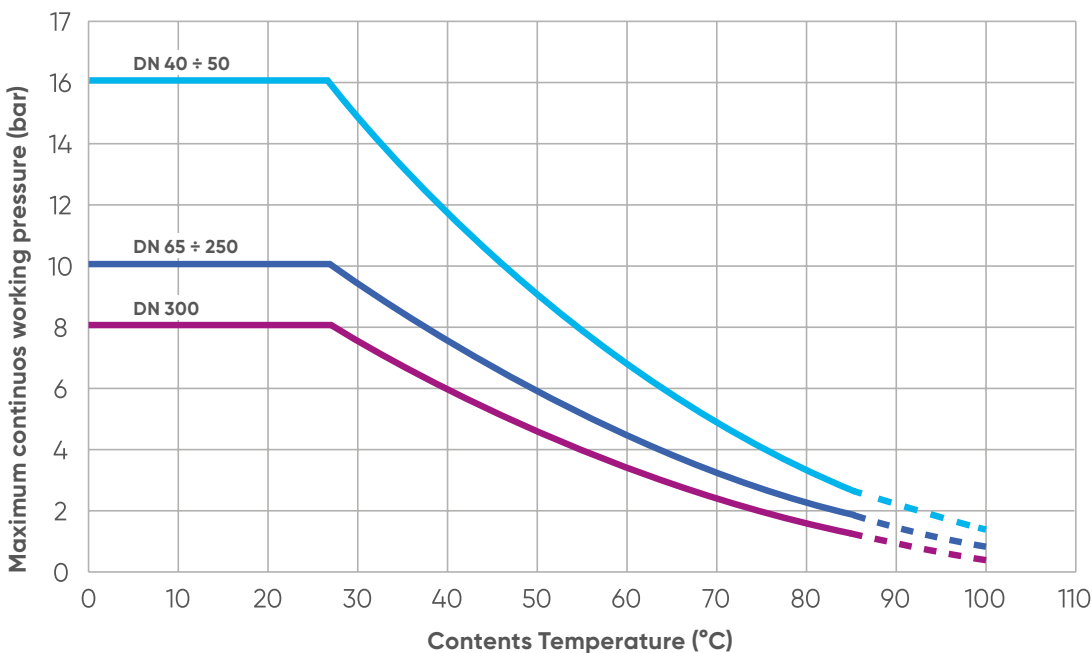

2.4.3 Hydraulic Calculation

The processes used for the production of pipes and fittings in thermoplastic resins allow to obtain extremely smooth internal surfaces characterized by low surface roughness coefficients.

Therefore the hydraulic behaviour of the fluid transported in thermoplastic pipes is comparable to the motion of fluids within smooth tubes and remains practically unchanged over time as the high smoothness of the internal walls does not allow the development of corrosion and encrustation. As regards biological resistance, in fact, PVC and CPVC piping systems are resistant to fungi and bacterial growth, especially those that normally cause corrosion in metal piping systems.

By the way, in general a pipe is subject to the action of a force that, opposing the direction of motion, cause a dissipation of energy by the fluid itself.

This dissipation, which can be evaluated in a pressure drop, is usually called friction loss or head loss.

In general in industrial pipes there are two types of head losses:

- distributed head losses: these occur when the loss of energy is generated by the surface friction developed between the liquid and the pipe walls, so they are present and distributed everywhere in the pipes. The friction is a function of the roughness of the pipe, its size, the physical properties of the fluid transported, its density and viscosity and the speed of the fluid transported;
- localized head losses: in this case the energy loss is generated by the form friction as there is a change of direction of the fluid in the presence of valves and fittings like bends, elbows, tees and other shapes.

Obviously, the total pressure drops inside a system can be found adding up all distributed and localized head losses.

In general, the distributed losses can be greater or lower than the localized ones depending on the application: for example if you are dealing with a long straight pipe with just few other obstacles that can create an energy loss, most of the pressure drops will be due to distributed pressure drops.

Otherwise, in case for example of a compact skid where valves and elbows are predominant and just a little straight pipe portions are required, localized head losses will prevail.

If the physical characteristics of the fluid, the dimensions of the pipe and the hydraulic flow are known, there are various mathematical correlations that allow to evaluate the pressure drops developed by a liquid that runs through the plastic pipes.

These three parameters are interconnected. Their relationship is expressed by the following equations.

Flowrate can be calculated as:

$$Q = A * V$$

where:

Q = flowrate (m³/s)

A = pipe section (m²)

V = velocity (m/s)

Velocity can be calculated as:

$$V = \frac{Q}{A} = \frac{4 * Q}{\pi * Di^2}$$

where:

Di = internal diameter

Generally, a fluid in motion in a pipeline could have laminar motion if the mass elements of the fluid have velocities parallel to the direction of motion and have no radial components.

On the other hand, if the elements of the fluid in addition to having velocities parallel to the direction of motion have a radial component it is a turbulent motion.

To determine whether the flow through the pipes is laminar or turbulent Reynolds' Number, indicated by Re, is used.

This is a dimensionless number applied in thermodynamics; its value separates the two conditions according to the shape of the body in which the fluid is carried as well as the characteristics of the fluid.

For example, in the case of a fluid inside a tube:

- for values $Re < 2500$ the system has laminar flow;
- for values $2500 < Re < 4000$ the transition regime is crossed;
- for values $Re > 4000$ there is a turbulent flow.

Reynolds' Number can be calculated by the following equations:

$$Re = \frac{V * Di}{\nu} \quad Re = \frac{\rho * V * Di}{\mu}$$

where:

Re= Reynolds' Number (-)

V = velocity of flow (m/s)

Di = internal diameter (m)

ν = kinematic viscosity (m²/s)

ρ = density of fluid (kg/m³)

μ = dynamic viscosity (kg/(m * s))

To conclude the topic about velocity, in addition to the formula described above, it is important to remember how the fluid's velocity can be measured inside the pipeline: this is done through flow sensors, described in next chapters, that measure the local velocity of the flow (V_m) in order to then be able to calculate the average velocity (V_a) and the volumetric flowrate.

As regards the measuring point of the flow velocity inside a pipe, two different positions are suitable:

- critical position: the speed sensor is located where the local speed corresponds to the average speed, and this usually occurs at 12% of the internal diameter. In this case the average speed corresponds to the measured local speed, therefore $V_a = V_m$;
- central position: the speed sensor is placed in the centre of the tube section. The local speed corresponds to the maximum speed: $V_m = V_{max}$

In this way it is possible to understand how the velocity influences the fact that the motion is laminar or turbulent, since velocity is present in the formula to calculate the Reynolds number.

The velocity profile of a laminar motion is parabolic, with the maximum value on the axis of the pipe, where $V_{max} = 2 * V_{average}$, and a gradually decreasing velocity near the wall, in fact next to the pipe the velocity is zero.

On the other hand, the velocity profile of the tubular motion is more flattened than the parabolic one: the velocity is close to the maximum value even near the pipe but next to the wall the velocity is zero.

Speed profiles of laminar motion and turbulent motion are represented in the picture.

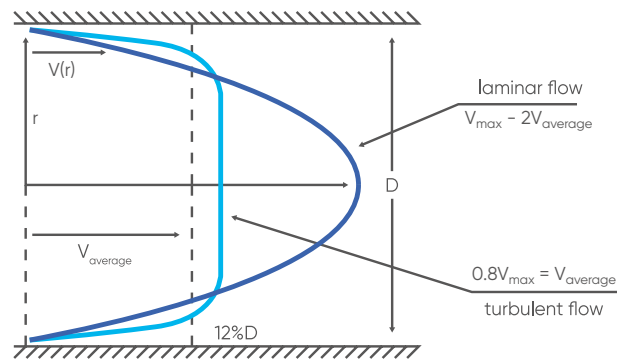

2.4.3.1 Distributed head loss calculation

As a fluid flows through a piping system, it will experience a head loss depending on, among other factors, fluid velocity, pipe wall smoothness and internal pipe surface area.

There are several methods to calculate the pressure loss in a piping system, but the most common two are Darcy-Weisbach method and Hazen and Williams method.

Hazen and Williams method is the most common accepted method to calculate the pressure drop in plastic pipes, while Darcy-Weisbach method is the most universally accepted, as it applies to pipes of every kind of material.

Darcy-Weisbach method

Darcy-Weisbach formula it is used for the calculation of the pressure losses inside a pipe and represents one of the pillars of current fluid dynamics.

It is valid for laminar and turbulent flow according to what value is given to the friction coefficient λ .

It is described in the following equation:

$$h = \frac{\lambda * V^2}{2 * g * Di}$$

where:

h = head loss (m/m)

V = velocity (m/s)

g = gravity acceleration (m/s^2) = 9.81 m/s^2

Di = internal diameter (m)

λ = pipe friction coefficient (-)

λ , the friction coefficient, usually varies between 0 and 0.02 for polymers.

By the way its value can also be obtained from Moody's diagram.

This is a bilogarithmic diagram and it is used to calculate the pipe friction coefficient by knowing relative roughness and the Reynolds number of the flow that passes through it. Once the coefficient has been calculated, it is enough to use the known laws of fluid mechanics to easily determine the pressure drop.

Today its importance is mainly didactic since the numerical solution is easily implementable on a computer, but in its absence it is the only viable way since there is no general analytical solution of the correlation.

In the left part the diagram is composed of a single straight line, which represents the friction factor in laminar motion, described by low values of the Reynolds number.

In the far right part of the Moody diagram there is a bundle of curves: they represent the different values of relative roughness. Depending on this value, once the Reynolds number relative to the motion is known, it is possible to know the value of λ .

This area that represents the turbulent conditions is in turn divided into two further parts:

- the first area, more to the left, in which the flow has a turbulent transition motion.
- the second area, more to the right, in which the curves tend to arrange themselves parallel to the abscissa axis, which correspond to a situation of turbulent motion.

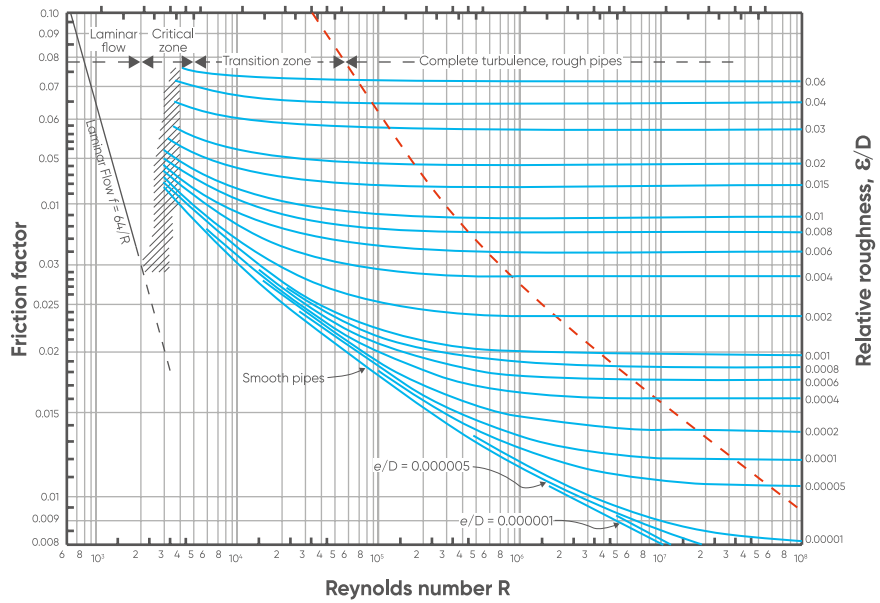

If the flow is laminar ($Re < 2500$), the friction factor can be considered as $\lambda = \alpha (Re)$ and more specifically:

$$\lambda = \frac{64}{Re}$$

If the flow is turbulent ($Re > 4000$), as it usually happens in plastic pipes, the friction doesn't depend only on Reynolds' Number but also on the relative surface roughness coefficient (ϵ/D_i), so:

$$\lambda = \alpha \left(Re * \frac{\epsilon}{D_i} \right)$$

Therefore for a turbulent flow the friction coefficient λ can be calculated by the Colebrook and White equation:

$$\frac{1}{\left(\lambda\left(\frac{1}{2}\right)\right)} = -2 \log \left(\frac{(\epsilon / D_i)}{3.71} + \frac{2.51}{\left(Re * \lambda\left(\frac{1}{2}\right)\right)} \right)$$

where:

λ = friction coefficient

ϵ = absolute roughness coefficient (mm)

ϵ/D_i = relative surface roughness coefficient (-)

Re = Reynolds' Number

In addition, from a practical point of view, it may be useful to consider this simplified formula that does not take roughness into account:

$$\lambda = 0.079 * Re^{-0.25}$$

Hazen and Williams method

The Hazen and Williams formula is valid for turbulent flow and is described as:

$$h = 10.666 * C_{hw}^{(-1.85)} * D_i^{(-4.87)} * Q^{(1.85)}$$

where:

h = Head loss (m/m)

Q = volumetric flow rate (m³/s)

C_{hw} = flow coefficient (-)

D_i = internal diameter (m)

This correlation is valid only for the calculation of water carrying pipes and it is recommended to use it for diameters greater than 50 mm.

The flow coefficient is a function of the construction material and is obtained from experimental tests: in the following table values of flow coefficient are reported for different construction materials.

Kind of pipe	Value of C_{hw}	
Cast iron or steel pipe with smooth interior surface	120	New
	110	10 years old
	90	20 years old
	70	50 years old
UPVC	145 – 160	
PP and PE pipes	140 – 150	

To avoid calculations it is shown the nomogram of Hazen and William with flow coefficient $C_{hw} = 100$. By this, it is sufficient to draw a line joining the two known coefficients to obtain the unknown one.

For example, by knowing the flow rate and the diameter of the pipe it is possible to obtain the pressure drop.

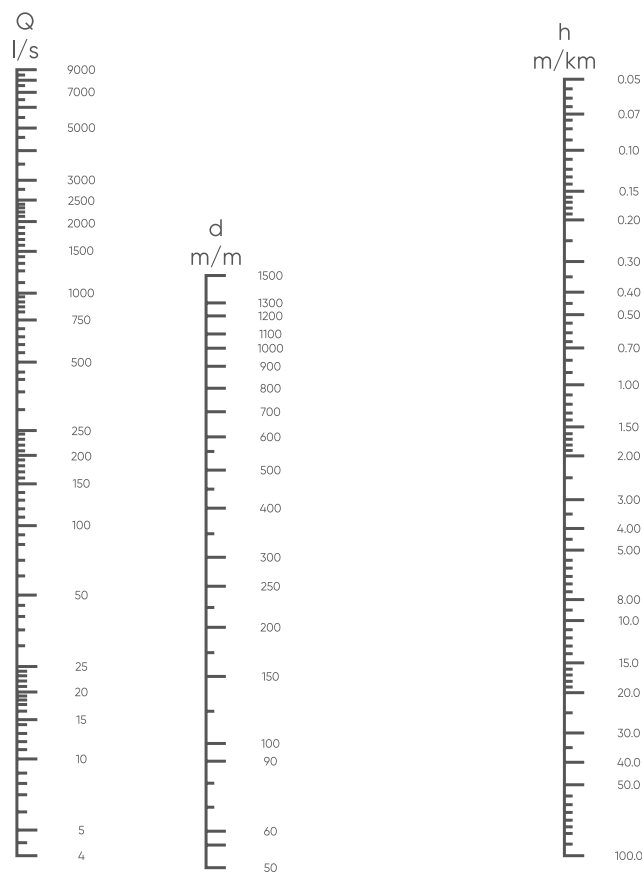

If C_{hw} has a different value, the values of volumetric flow (Q) and head loss (h) obtained from the nomogram must be multiplied by the relative constructive coefficients M_q and M_h described in the table.

Conversion factor for C_{hw} different from 100

C_{hw}	M_q	M_h
70	0.70	1.93
90	0.90	1.22
100	1.00	1.00
110	1.10	0.84
120	1.20	0.71
130	1.30	0.62
140	1.40	0.54
150	1.50	0.47
160	1.60	0.42

After all this calculation, it is possible to assert that a quick sizing method exists: in fact, as can be seen from Hazen and William equation, pressure loss is inversely proportional to the fifth power of the internal diameter.

Therefore, after calculating pressure drop for one diameter, it is possible to calculate other diameters by ratio of the fifth powers. The following relationship is used:

$$h_2 = \frac{h_1 * D_1^5}{D_2^5}$$

where

h_1 = pressure drop of the known diameter

h_2 = pressure drop for the new diameter

D_1 = known internal diameter (m)

D_2 = new internal diameter (m)

PRACTICAL EXAMPLE

Calculate the head loss of a circular section pipe carrying water, with a diameter $D_i = 50$ mm and a flowrate $Q=1$ l/s. Consider $\lambda=0.02$.

To calculate the head loss by Darcy-Weisbach equation it is necessary to find the value of velocity.

$$V = \frac{Q}{A} = \left(\pi * \left(\frac{D_i}{2} \right)^2 \right) = 5 \text{ m/s}$$

Now, by applying Darcy-Weisbach equation, it is possible to get the pressure drop:

$$h = \frac{(\lambda * V^2)}{(2 * g * D_i)} = 0.51 \text{ m/m}$$

2.4.3.2 Localized Head Loss Calculation

Distributed head losses are not the only causes of pressure drops in hydraulic pipes, in fact there are also the so-called concentrated or localized head losses. They are due to obstacles such as bends, elbows, valves, everything that can cause a sudden change in pressure inside the system.

To calculate all the localized head loss in the system it is possible to add up each of them:

$$\Sigma \Delta p_{localized} = \Delta p_{RF} + \Delta p_{RV} + \Delta p_{geod} + \Delta p_{valv}$$

where:

Δp_{RF} = pressure loss in fittings

Δp_{RV} = pressure loss at pipe joints

Δp_{geod} = pressure difference due to elevation

Δp_{valv} = pressure loss inside a valve

Pressure loss in fittings

A large number of experimental tests have indicated that the head losses caused by fittings are proportional to the high flow velocity at a constant exponent varying between 1.8 and 2.1.

For usual hydraulic calculations it can be assumed that the loss of pressure due to the passage of a fluid in a fitting is proportional to the square of the average speed, as described in DVS 2210:

$$\Delta p_{RF} = \frac{\xi_{RF} * \rho}{(2 * 10^5) * V^2}$$

where:



Δp_{RF} = pressure drop (bar)

ξ_{RF} = resistance coefficient for fitting (-)

ρ = density of the transported substance (kg/m^3)

V = velocity (m/s)

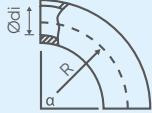
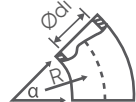
As regards the coefficient ξ , it is characteristic of the type and size of the most common fittings and can easily be found on DVS 2210.

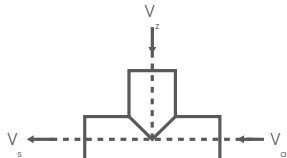
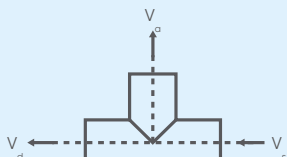
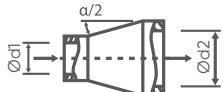
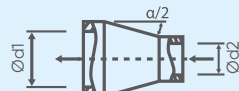
Type of fittings	Parameter	Resistance Coefficient ξ			Drawing  = Flow Direction
Bends $\alpha = 90^\circ$	$R = 1.0 \times d_a$	0.51			
	$1.5 \times d_a$	0.41			
	$2.0 \times d_a$	0.34			
	$4.0 \times d_a$	0.23			
Bends $\alpha = 45^\circ$	$R = 1.0 \times d_a$	0.34			
	$1.5 \times d_a$	0.27			
	$2.0 \times d_a$	0.20			
	$4.0 \times d_a$	0.15			
Angles (elbows)*	$\alpha = 45^\circ$	0.30			
	30°	0.14			
	20°	0.05			
	15°	0.05			
	10°	0.04			
T pieces (90° pipe branches flow merging $V_s = V_a + V_z$)	$V_z/V_s = 0.0$	$\xi_z = -1.20$	$\xi_{cd} = 0.06$		
	0.2	-0.40	0.20		
	0.4	0.10	0.30		
	0.6	0.50	0.40		
	0.8	0.70	0.50		
T pieces (90° pipe branches flow separating $V_s = V_a + V_d$)	$V_a/V_s = 0.0$	$\xi_z = 0.97$	$\xi_{cd} = 0.10$		
	0.2	0.90	-0.10		
	0.4	0.90	-0.05		
	0.6	0.97	0.10		
	0.8	1.10	0.20		
Reducers, concentric (pipe expansion) ξ - values for $\lambda_R = 0.025$	Angle α	4...8°	16°	24°	
	$d_2/d_1 = 1.2$	0.10	0.15	0.20	
	1.4	0.20	0.30	0.50	
	1.6	0.50	0.80	1.50	
	1.8	1.20	1.80	3.00	
Reducers, concentric (pipe constriction) ξ - values for $\lambda_R = 0.025$	Angle α	4°	8°	20°	
	$d_2/d_1 = 1.2$	0.046	0.023	0.010	
	1.4	0.067	0.033	0.013	
	1.6	0.076	0.038	0.015	
	1.8	0.031	0.041	0.016	
	2.0	0.034	0.042	0.017	

* For elbows with $\alpha=90^\circ$ it is suggested to consider a resistance coefficient $\xi=0.60$

In addition to the following expressions, a common method of expressing pressure drops of the fittings is to relate them to pipe in terms of equivalent pipe length (L/D_i). This ratio L/D_i is the equivalent length in diameters of straight pipe which causes the same pressure drop as the fitting in the same flow conditions.

Pressure loss at pipe joints

No exact data can be given about pressure losses at the pipe joints because the geometrical dimensions (for example weld beads) are not constant.

It is recommended that the calculation of the pressure loss should be based on a resistance coefficient $\xi_{RV}=0.1$ for each joint in the plastic pipe system, such as butt welds and socket-fusion joint assemblies as well as for flanges. On this basis, on DVS 2210 the following equation is suggested:

$$\Delta p_{RV} = \frac{\xi_{RV} * \rho}{(2 * 10^5) * V^2}$$

where:

Δp_{RV} = pressure drop (bar)

ξ_{RV} = resistance coefficient of the joints (-)

ρ = density of the transported substance (kg/m³)

V = velocity (m/s)

Moreover, in order to determine the approximate pressure loss at the joints of a pipeline, it is sufficient to assume an increase of approximately 15% compared with the pressure loss of the fittings Δp_{RF} .

Pressure difference due to elevation

This contribution need to be considered when there is a difference in elevation between the bottom and the top of the pipeline.

$$\Delta p_{geod} = \Delta h_{geod} * \rho * 10^{(-4)}$$

where:

Δp_{geod} = Geodetic pressure difference (bar)

Δh_{geod} = Difference in elevation of the pipeline (m)

ρ = density of media (kg/m³)

Pressure loss in valves

For the evaluation of the pressure losses caused by the passage of a fluid through a valve it is a practical rule to refer to a specific capacity coefficient conventionally called flow coefficient K_v .

In particular it is possible to calculate the pressure loss inside a valve by this equation:

$$\Delta p_{valv} = \rho \left(\frac{Q}{K_v} \right)^2$$

where:

Δp_{valv} = pressure drop inside a valve (bar)

Q = flow rate (m³/h)

ρ = specific mass of the fluid compared to the specific mass of water at 15 °C (-)

K_v = flow rate coefficient (m³/h)

K_v is the most important parameter used to calculate pressure drop in a valve.

It is the flow rate which flows through a valve at a given pressure drop and it can be determined by using the following equation:

$$K_v = Q * \left(\frac{\rho}{\Delta P} \right)^{\left(\frac{1}{2} \right)}$$

where:

K_v = flow rate coefficient (m³/h)

Q = flow rate (m³/h)

ΔP = pressure drop (bar)

ρ = specific mass of the fluid compared to the specific mass of water at 15 °C (-)

By the flow coefficient K_v it is possible:

- to size a valve: by knowing the pressure drop and the flow coefficient the most suitable diameter of the valve can be identified;
- to calculate the flow rate through the valve, as a function of the pressure difference and the flow coefficient;
- to calculate the concentrated pressure drop of the valve: once the flow rate and the flow coefficient are known, Δp is determined.

Nominal flow coefficient K_{v100}

It is important to notice that the term nominal flow coefficient, indicated by K_{v100} (l/min), refers to the maximum possible flow coefficient, therefore when the valve is completely open, at a temperature of 20 °C with a pressure drop $\Delta p = 1$ bar.

It essentially depends on:

- nominal diameter of the valve, as larger valves give higher flow coefficients;
- type of valve.

The following table can be useful to compare the values of K_{v100} (l/min) of the main valves adopted in industrial installation (VKR, VKD, DK, FK models) with nominal diameter between 10 and 100 mm.

Valve	DN									
	10	15	20	25	32	40	50	65	80	100
VKR	83	88	135	256	478	592	1068	-	-	-
VKD	80	200	385	770	1100	1750	3400	5250	7100	9500
DK	-	112	261	445	550	1648	1087	1600	-	-
FK	-	-	-	-	-	1000	1285	1700	3550	5900

Often, instead of the nominal flow coefficient, the relative flow coefficient is used, which obviously has a lower value.

In particular, reference is made to the relative K_v when the shutter opening is not complete, or when a working fluid other than water is used (for example a chemical fluid, it gives different flow coefficients from the nominal ones, which refer to water).

The nominal value is indicated by the manufacturer who provides in the product data sheet the adjustment characteristic or the trend of the factor with nominal diameter and opening, usually in graphical form (in abscissa the stroke of a piston or the rotation of the ball, in ordinate the flow coefficient), as can be seen in the image for the diaphragm valve DK.

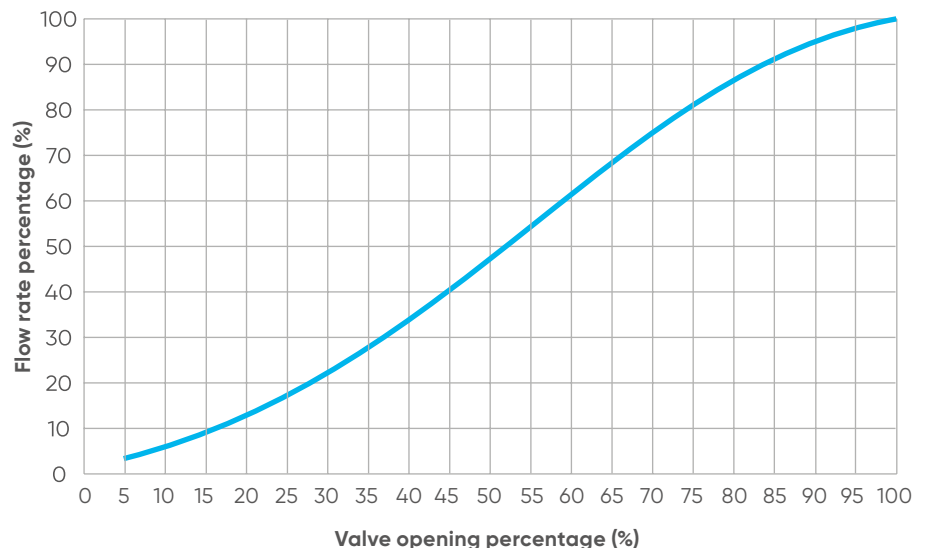

Relationship between K_v and C_v

As described before the European legislation measures the volumetric flow rate in m^3/h , the pressure in bar and refers to the flow coefficient K_v .

On the other hand, in Anglo-Saxon countries, reference is made to a flow coefficient with the abbreviation C_v , which corresponds to a flow rate of water, expressed in GPM, at a temperature of $60^\circ F$ with a pressure drop of 1 psi.

The two coefficients are correlated by the following relationship:

$$K_v = 0,865 C_v$$

Series or parallel configuration

From a practical point of view, if you want to evaluate the specific capacity of a group of several valves in series, each of which with its own K_v , the resulting total capacity will be deducible from the following relationship:

$$\frac{1}{(K_{vtot})} = \frac{1}{K_{v1}} + \frac{1}{K_{v2}} + \dots + \frac{1}{K_{vn}}$$

The previous mathematical correlation indicates that the total specific capacity of several elements in series is less than the smallest specific capacity characteristic of an element in the series.

If the valves are positioned in parallel, the resulting total capacity will then be deducible from the following relationship:

$$K_{vtot} = K_{v1} + K_{v2} + \dots + K_{vn}$$

Therefore, the total specific capacity of several elements in parallel is the arithmetic sum of the specific capacities of the single elements.

PRACTICAL EXAMPLES

- Calculate the total specific capacities of the group of valves belonging to the circuit in UPVC, assuming negligible distributed pressure loss.
 - for the valves (V_1, V_2) in series placed on a 32 mm pipe;
 - for the entire group of three valves, where V_3 is placed on a 50 mm pipe.

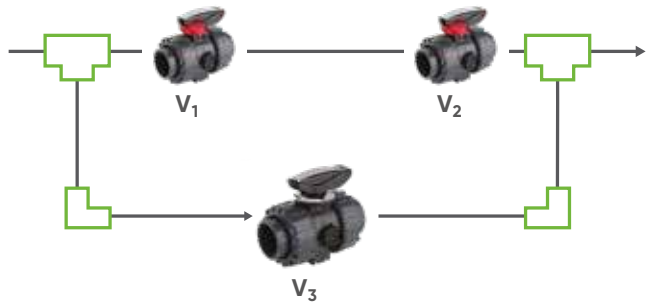

The energy loss is related to the presence of the valves, since there is a big amount of them, for this reason it is suggested to focus on the localized pressure drops given by the valves.

To do this, it is necessary to refer to K_{v100} of each single valve according to nominal diameter of the pipe, as shown in the following table.

Valve name	Valve type	DN	K_{v100} (l/min)
V₁	VKD	32	1100
V₂	VKD	32	1100
V₃	VKR	50	1068

At this point it is possible to calculate the pressure drops in series or parallel for the entire circuit:

- Series:

$$\frac{1}{K_{vtot}} = \frac{1}{K_{v1}} + \frac{1}{K_{v2}} = 0.0018 \text{ min/l} \quad K_{vseries} = \frac{1}{0.0018} = 555.5 \text{ l/min}$$

- Parallel:

$$K_{vtot} = K_{vseries} + K_{v3} = 1623.5 \text{ l/min}$$

- Given a flow rate of 13.2 m³/h and the forecast of a pressure drop of 0.4 bar, the K_v will be:

$$K_v = \frac{13.2}{(0.4)^{0.5}} = 20.87 \text{ m}^3/\text{h}$$

It will be necessary to identify a valve with a K_v of 20.87, so by starting from this project data it is possible to identify the most suitable valve on the catalogue.

- Given a flow rate of Q = 2.2 m³ / h and a K_v = 2.5, what will the pressure drop be?

$$\Delta P = \left(\frac{2.2}{2.5}\right)^2 = 0.77 \text{ bar}$$

2.4.4 Valve flow regulation and sizing

The choice of the right valve is a fundamental step during the design part, since every operation in the system being carried out by the valves installed on the piping essentially depends on their performance.

In general, main components of a manual operated valve can be summarized in:

- operating mechanism: it is the device that generates the movement of the stem and the shutter, such as a handle, a wheel or a lever according to the type of valve.
- shutter: it is the mobile component that modifies the fluid passage section until it closes or opens it completely. According to the different valves it could be a ball, a disk or a diaphragm.
- valve body: is it the main structure of the valve, in where there are the passages intended for the sliding of the fluid.
- seal: it can be made of different materials, such as EPDM, FKM, PTFE in order to deal with several different medium.

The selection of a valve is based on its function and the way in which it will be operated in the system. In general, valves are used to perform at least one of three functions:

- shut off: for on-off service, the most commonly used valves are ball valves and butterfly valves;
- throttling: for throttling or flow regulating, the most common are diaphragm valves, butterfly valves or our FIP VKR regulating ball valve;
- preventing backflow: for preventing reversal or backflow, the most common are ball check valves: piston, ball, spring or disk versions.

Since there can be more than one choice for a particular function, the selection process can be refined by considering specific process requirements.

These include:

- flowing medium: it is necessary to know if the fluid can cause problems to the wetted materials of the valve according to its main characteristics, such as corrosiveness, abrasiveness, viscosity, temperature, pressure and if it is a clean or a dirty fluid;
- the compatibility of the valve's fluid-control elements with the flowing medium;
- physical space requirements: it is necessary to analyse weight limitations and operational requirements. Manually operated valves offer a choice of levers, gears, and other handles, depending on size, while remotely operated valves can be actuated either electrically or pneumatically.

After this introduction about valve's features it is possible to talk about sizing.

The dimensioning of a valve essentially depends on two factors:

- process parameters;
- choice of the type of valve;

As regards the process parameters, it is necessary to take into account the flowrate and inlet/outlet pressure as described previously.

The choice of the valve is directly linked to the characteristic curves.

These curves are different for each kind of valve and describe the variation of the flow rate as a function of the shutter stroke. They are obtained by shaping the geometry of the shutter, which can be chosen from different types: there are shutters with rapid, linear or equal percentage opening.

In particular, as figure below shows, membrane valves are in general characterized by a rapid opening of the shutter: the flow rate increase occurs almost exclusively in the first portion of the shutter opening after which further increases in the stroke result in low increases in flow rate.

The ball valve instead has an equal percentage opening, therefore with this shutter equal increases in the opening stroke correspond to a constant percentage increase in the flow rate at the same differential pressure: the valve delivers most of the flow in the last opening fraction.

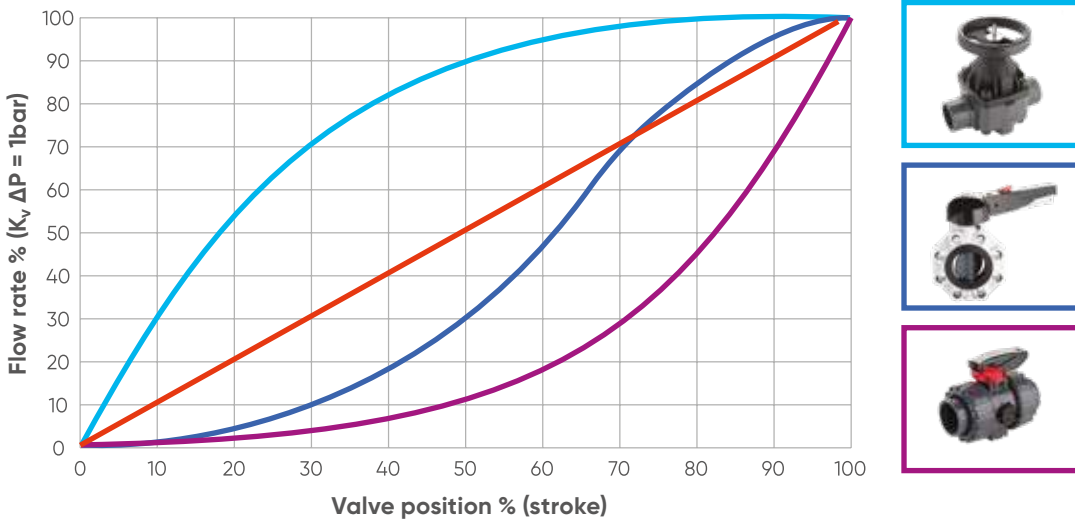

With FIP diaphragm valve DK and regulation ball valve FIP VKR, it is possible to obtain a regulation close to linearity between the valve opening and the flow rate.

Linear regulated valves are essential when it is needed to precisely regulate the process maintaining limited variations in flow rate.

In this picture characteristic the curves of the FIP diaphragm valves DK and ball valve VKR are represented in order to note their linear trend.

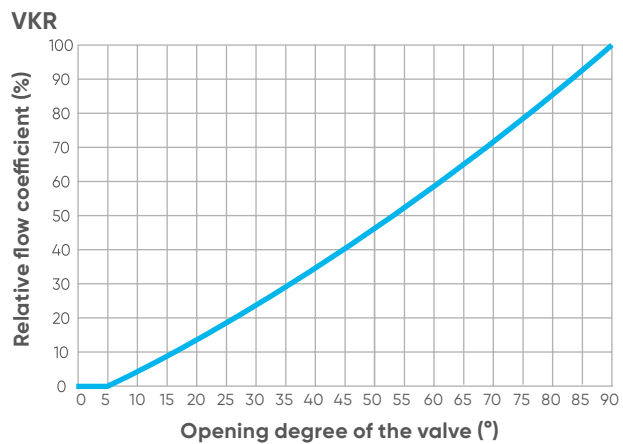
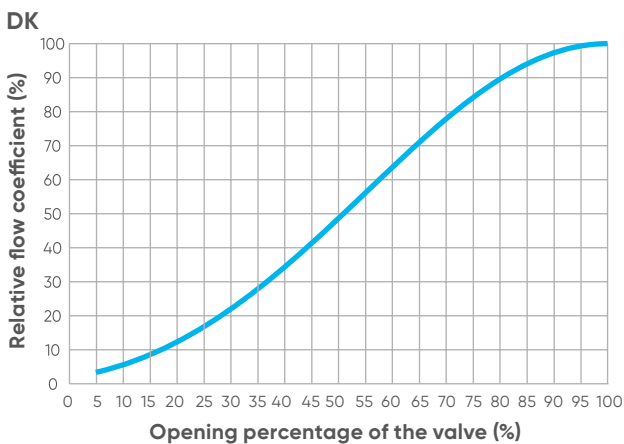

To get to know the characteristic curves of each valve it is advisable to look at the Aliaxis product catalogues.

In addition to the manual valves, nowadays actuated valves are very common for flow regulation and control, since they increase profit and productivity, provide closer control of critical processes and help to eliminate human error.

The demand for electrical and pneumatic valves has been steadily increasing due to increasing labour costs for manually operated valves, especially in remote locations.

Operational advantages of using an actuated valve are:

- adapts easily and economically to full modulating control.
- allows automatic sequencing of valve operation in multi-stage or multi-mix systems that are difficult, if not impossible, to coordinate manually.
- offers a variety of cost and labour saving options that fit process requirements and industrial environments more precisely.
- provides fail-safe modes and eliminates the need for workers to manually operate a valve carrying hazardous fluids.

The choice of actuators should not be only influenced by either features or price. Consideration should also be given to the cost of supplying motive power, installation and maintenance, service life and possible future replacement.

There are two basic types of actuators; electric and pneumatic. If electricity and air are available, the first consideration is the type of power desired. On the other hand, pneumatic actuators are normally less expensive, but, in smaller sizes, the electric actuator's lighter weight and a simpler installation make it ideal for many applications.

Consideration should also be given to the speed control of both electric and pneumatic actuators. Closing a valve too quickly on flowing fluid can cause water hammer and subsequent damage to the valve and related piping. The speed of electric and pneumatic actuators is different, in addition some pneumatic actuators can be adjusted in-line, by acting on air pressure and air flow, to obtain the correct cycle time for a specific application.



This picture shows FIP ball valve VKD with electric actuator.



This picture shows FIP diaphragm valve DK with linear pneumatic actuator.

PRACTICAL EXAMPLES

- By knowing the operating conditions of the process, the goal is to understand the range of flow rates that can be managed by the chosen valve.

Let's consider a VKR DN 50 valve, into which water flows, having an inlet pressure of 6 bar and an outlet pressure of 3 bar.

Referring to the table in the catalogues, for each DN is possible to obtain the K_{v100} value, that is the flow rate in l/min which generates a pressure drop of 1 bar with the valve completely open.

DN	10	15	20	25	32	40	50
K_{v100} (l/min)	83	88	135	256	478	592	1068

In this case for a DN 50 a $K_v 100=1068$ l/min is obtained.

Knowing that $P_{inlet} = 6$ bar and $P_{outlet} = 3$ bar, it is possible to calculate $\Delta P = P_{inlet} - P_{outlet} = 3$ bar.

From the value of K_{v100} and the pressure drop, it is possible to calculate the flow rate using the following formula:

$$Q_{fullyopen} = K_{v100} * \sqrt{\frac{\Delta p}{\rho}}$$

Alternatively, to avoid this calculation, you can use the calculator tool on Aliaxis website.

Carrying out the calculations it results: $Q_{fullyopen} = 1849.8$ l / min, corresponding to 110.9 m³/ h.

It is essential to remember that this flow rate can be obtained with a fully open VKR DN50 valve.

In order to analyze the flow rate variation depending on the valve opening degree, it is advisable to consider the following graph, where the horizontal axis represents the valve opening degrees, while the vertical axis the relative flow coefficient ($K_{v\%}$).

For example, assuming to open the valve by 60 degrees, we have a Kv% of 60%, obtaining the following flow rate:

$$Q_{final} = K_{v\%} * Q_{fullyopen} = 0.60 * 110.9 = 66.54 \text{ m}^3/\text{h}$$

Therefore this valve can be recommended to manage a flow rate between about 20° and 80° degree of opening, since it is important to remember that to get an optimal regulation, it is advisable to size the valves in order to keep the desired flow rate within the central area of the regulation curves.

For example for 20 degrees we have a Kv% of 13%:

$$Q_{final} = K_{v\%} * Q_{fullyopen} = 0.13 * 110.9 = 14.4 \text{ m}^3/\text{h}.$$

For 80 degrees we have a Kv% of 87%:

$$Q_{final} = K_{v\%} * Q_{fullyopen} = 0.87 * 110.9 = 96.5 \text{ m}^3/\text{h}.$$

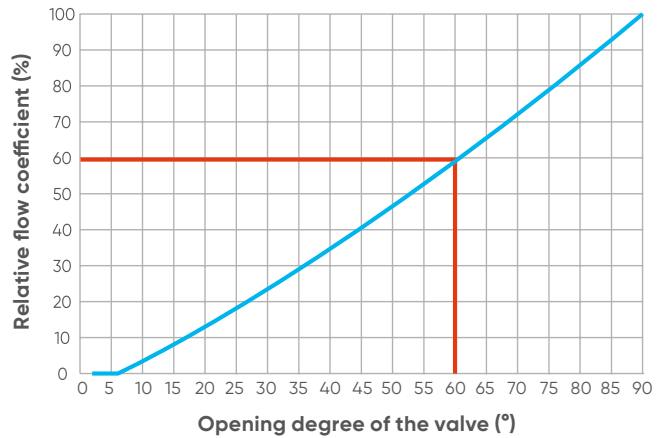

- By knowing the flow rate and the pressure drop, the aim is to understand what size and degree of opening the valve must have to manage this quantity of volume.

Let's consider an inlet flow Q=300 l/min and a VKR valve with an inlet pressure of 6 bar and an outlet pressure of 3 bar.

Knowing that P_{inlet} = 6 bar and P_{outlet} = 3 bar, it is possible to calculate ΔP = P_{inlet} - P_{outlet} = 3 bar.

At this point, since the transported fluid is water, it is possible to calculate the K_{v100}, the flow rate in l/min which generates a pressure drop of 1 bar with the valve totally open, using the following formula:

$$K_{v100} = Q * \sqrt{\frac{\rho}{\Delta p}}$$

K_{v100} = 173.20 l/min is obtained.

Alternatively, to avoid this calculation, you can use the calculator tool on Aliaxis website.

Referring to the table in the catalogues, it is possible to identify the DN according to the calculated K_{v100}. Obviously it is always necessary to choose a DN having the K_{v100} higher than the one calculated in order to be located at the center of the regulation curve.

For example, in this case, having a K_{v100} = 173.20 l/min, it is recommended to use at least a DN25.

As can be seen in the table, DN25 corresponds to a K_{v100}= 256 l/min.

DN	10	15	20	25	32	40	50
K _{v100} /l/min	83	88	135	256	478	592	1068

The next step is to find the Kv% value by simply making the ratio between the calculated Kv100 and the one corresponding to DN 25.

$$K_{v\%} = 173.20/256 = 0.676 = 67.6\%$$

At this point it is possible to find the degree of opening of the valve corresponding to the percentage of K_v = 67.6% through the following graph, that shows the degree of opening of the valve on the horizontal axis and the relative flow coefficient (K_{v%}) on the vertical one.

Crossing the curve for a K_{v%}= 67.6% a degree of opening of the valve at about 65° is obtained.

It is important to notice that these values are located in the central area of the regulation curve, which allows you to have a margin to increase or decrease the flow rate.

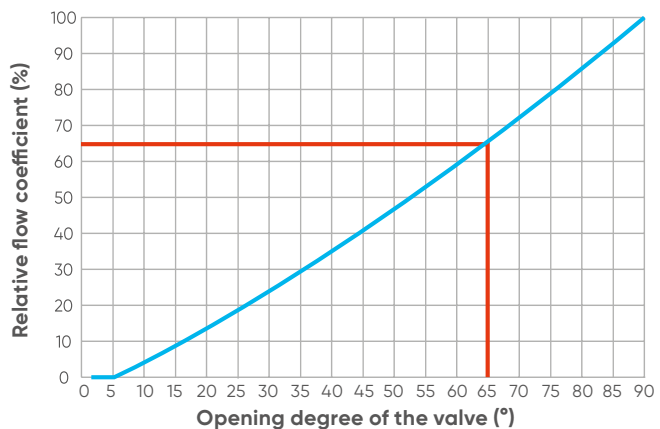

2.4.5 Pressure surge

2.4.5.1 Water Hammer

Water hammer is the hydraulic term used to describe the momentary increase in pressure in a pipe when the flow is stopped or started quickly. In fact, when a rapid handle is carried out aimed at decreasing or increasing the flow of a liquid, a perturbation is generated in the form of a pressure wave which, propagating along the pipeline, dynamically stresses the walls of the same until its progressive damping.

It is also necessary to say that water hammer is not only a system problem, but also a safety problem, as in addition to the common cases of rupture and interruption of the pipes, it has also caused some catastrophic events.

The most frequent causes of the phenomenon, which can cause significant damage to joints, valves, measuring equipment and pumps, are usually due to:

- quick closing of the interception valves;
- abrupt stop of the power supply to the lines;
- start of pumping.

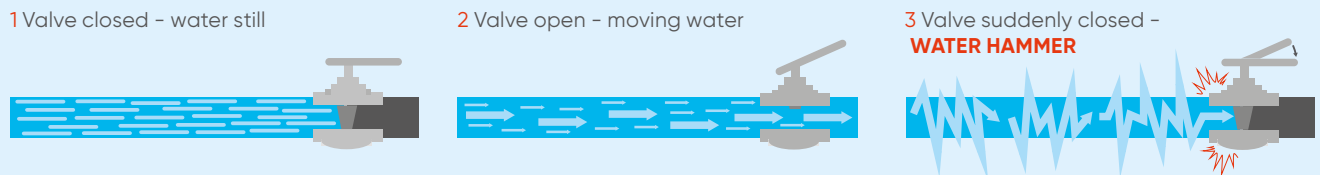

In the picture it is possible to see a graphic representation of the water hammer due to the sudden closure of a valve with the following formation of the pressure wave that propagates in the pipe.

Therefore, to minimize the possibility of hydraulic shock damage, a proper design has to be well thought out. The following suggestions might help to avoid problems:

- in any piping system, including thermoplastic, a liquid velocity not exceeding 1,5 m/s will lessen hydraulic shock effects, even with quick-closing valves;
- using actuated valves with a specific closing time will reduce the possibility of inadvertent opening or closing of a valve too quickly;
- evaluate flow at pump start-up and during spin-down, also determine how much air, if any, is introduced during pump start-up;
- if possible, when starting a pump, partially close the valve in the discharge line to minimize the volume of liquid that is rapidly accelerated through the system. Once the pump is up to speed and the line completely full, the valve may be opened;
- use surge control devices and standpipes wisely to give flow storage during surge and to minimize column separation. Check valves can be used near pumps to help keep lines full;
- use properly sized vacuum breaker-air relief valves to control the amount of air that is admitted or exhausted throughout the system.

To evaluate the effects of the water hammer, a mathematical model based on the theory of propagation of the sound wave in a fluid medium is used, which involves both the mechanical properties of the tube and the physical characteristics of the fluid in motion.

In fact, as can be seen in the following formula, the velocity of the pressure wave caused by an instantaneous flow stop is a function of the modulus of elasticity both of the fluid and of the pipeline material and of the ratio between thickness and internal diameter.

$$V_{pw} = \left(\frac{K}{\rho * \left(1 + \frac{K + Di}{t * E} \right)} \right)^{\left(\frac{1}{2} \right)}$$

where:

V_{pw} = velocity of the pressure wave (m/s)

K = modulus of elasticity of the fluid (Pa)

ρ = density of the fluid (kg/m³)

E = modulus of elasticity of pipe wall (Pa)

Di = internal diameter (mm)

t = wall thickness (mm)

Now that the speed of the pressure wave is known, it is necessary to understand if the system is able to withstand a possible water hammer.

The maximum pressure variation that could hit the system with a precise V_{pw} is calculated using the following formula:

$$\Delta p = V_{pw} * (V_1 - V_2) * \frac{\rho}{1000}$$

where:

Δp = maximum pressure variation (bar)

ρ = density of the fluid (kg/m³)

V_{pw} = velocity of pressure wave (m/s)

V_1 = velocity of the fluid before change (m/s)

V_2 = velocity of the fluid after the change (m/s)

Consequently the maximum and minimum pressures inside the system are calculated:

$$p_{max} = p + \Delta p$$

$$p_{min} = p - \Delta p$$

where:

p_{max} = maximum pressure (bar)

p_{min} = minimum pressure (bar)

p = expected operating pressure (bar)

Δp = variation of pressure after the water hammer (bar)

It is important to underline that for a given fluid different construction materials lead to different pressure increases: by keeping SDR value constant, the thermoplastic materials, characterized by low modulus of elasticity, cause lower pressure increases compared to traditional construction materials, as can be seen in the table.

	UPVC	PP	Cast iron	Carbon steel
DN (mm)	100	100	60	100
Di (mm)	93.6	90	48	94.3
D_p (m.c.a)	73	57	201	207

By knowing the maximum pressure that the system can reach, it is suggested to calculate the maximum safety factor (C_{max}) and compare it with the minimum safety factor (C_{min}) of each material described in previous chapters.

The following formula is the inverse of the one used for calculating the pressure inside a system, therefore :

$$C_{max} = \frac{(20 * \sigma)}{(p_{max} * (SDR - 1))}$$

where:

C_{max} = maximum safety factor

σ = hoop stress (N/mm²)

p_{max} = maximum pressure (bar)

SDR = Standard Dimension Ratio (-)

In particular, as regards the C factor, in the case of not frequent water hammer, the minimum safety factors of each material can be applied as mentioned above, but if the phenomenon occurs periodically C_{max} must be compared with $C_{min} = 3$.

The piping is suitable for not frequent water hammer if the calculated C_{max} is bigger than C_{min} .

Moreover, if C_{max} is also bigger than $C_{min} = 3$ it could be suitable for periodic water hammer too.

If the safety factor C does not correspond to no one of these safety criteria, then it is necessary to act on the sizing of the system.

Perturbation time is fundamental in water hammer's calculation, in fact the maximum overpressure develops when the stopping time of the motion, for example the closing of a valve, is less than or equal to the perturbation propagation time (t_c), which can be evaluated according to the following relationship:

$$t_c = \frac{(2 * L)}{V_{pw}}$$

where:

t_c = perturbation propagation time (s)

L = pipe length (m)

V_{pw} = velocity of pressure wave (m/s)

For mechanical devices with closing times $t \leq t_c$ are defined as "sudden maneuver" and induce a water hammer in the pipeline with overpressure at maximum intensity.

On the contrary, a closing time $t > t_c$ is defined as "slow maneuver" and causes a water hammer phenomenon with minor, if not negligible, overpressure.

To conclude, if all the variables present in the previous formulas are not available, in a practical way the following formula can be used to immediately calculate the overpressure due to water hammer:

$$\Delta p = \frac{2 * V * L}{g * t_c} * 0.1$$

where:

Δp = maximum pressure variation (bar)

V = velocity of the water at the beginning of closing (m/s)

L = pipe length (m)

g = gravity acceleration (= 9.81 m/s²)

t_c = perturbation propagation time (s)

Therefore the maximum pressure can be calculated as:

$$p_{max} = p_i + \Delta p = p_i + \frac{2 * V * L}{g * t_c} * 0.1$$

where:

p_{max} = maximum pressure (bar)

p_i = inlet pressure (bar)

Δp = maximum pressure variation (bar)

V = velocity of the water at the beginning of closing (m/s)

L = pipe length (m)

g = gravity acceleration (=9.81 m/s²)

t_c = perturbation propagation time (s)

2.4.5.2 Cavitation

Cavitation takes its name from the presence of macroscopic cavities within an incompressible fluid in motion.

The phenomenon of cavitation arises in the liquid when, for dynamic reasons, the local pressure falls below the corresponding value of the vapor pressure of the liquid and the gases dissolved in it, consequently the liquid evaporates and bubbles of vapor and gas are formed.

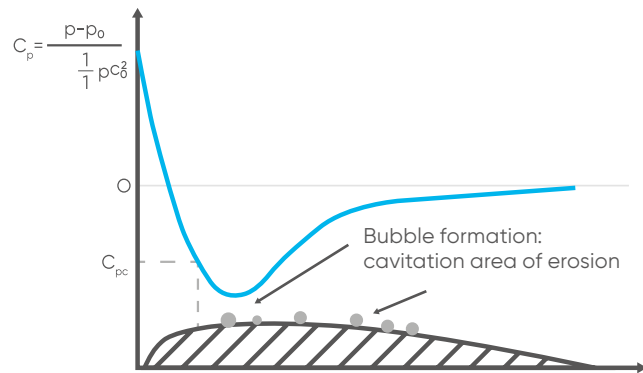

All this is aggravated by the fact that air dissolved in water is particularly rich in oxygen and therefore with a strong oxidizing power and an exceptional virulence in attacking the surfaces exposed to its action.

The formation of cavities becomes more intense the more the pressure is lowered, consequently leaving an increasingly reduced section useful for the passage of the liquid. Furthermore, the velocity of the liquid increases and this causes a further decrease in pressure, thus favouring the intensification of the phenomenon that is its origin, therefore it can be said that cavitation is self-elevating.

In general, cavitation can develop for two different reasons:

- the profile of a solid immersed in the current produces a lowering of pressure;
- a lowering of pressure due to a sudden interruption and consequent violent formation of bubbles.

The gaseous cores that cross the low pressure zone take on larger dimensions and the bubbles, dragged by the current, reach the zones of higher pressure where they contract: the effect of the higher external pressure translates into a convergence of the bubble walls towards the centre and so the bubble implodes.

This rapid contraction movement can release a high energy in the form of a shock wave or kinetic energy of the liquid, so in the case in which the phenomenon develops near a wall, an erosion effect follows that can reach impressive levels.

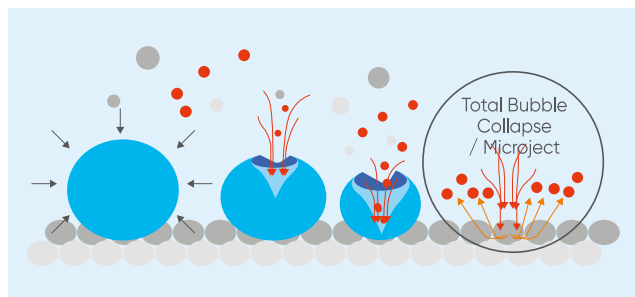

Therefore cavitation can occur, for example, at the ends of the blades of hydraulic turbines or pumps, or in a tube with a constriction in which, as claimed by Bernoulli theorem, an increase in speed corresponds to a decrease in pressure.

In this case the cavitation phenomenon can cause numerous vibrations and shocks which subject the walls to intense fatigue stress and cause corrosion or deformation of the material.

Anyway, in general it should be noted that the corrosion present on a plastic material is very different from that which appears on a metallic material.

The main difference is due to the surface of the products: metals, having an irregular and rough surface, retain external contamination more easily and consequently increase the risk of corrosion of the product.

An example of localized corrosion that occurs easily in metal is pitting corrosion. The latter consists in the formation of localized anodic areas that give rise to very deep cavities that pierce the material into a tapered shape or create very large caverns.

The surface of thermoplastic materials, on the other hand, being very smooth and not having caves in which localized corrosion can occur, does not give rise to similar phenomena: polymers stressed in a chemical environment create creeps on the surface and consequently the cracks propagate inside the material.

The degradation process of plastic therefore consists mainly of a change in properties, such as tensile strength or colour and shape, following the influence of one or more environmental factors such as heat, light, salt, acids or alkaline chemicals.

Actually cavitation is also a widespread phenomenon in valves due to the fact that these introduce more or less marked bottlenecks inside the systems depending on the position of the shutter. As the fluid passes through the constriction the velocity increases, while the pressure decreases.

If, at the point of minimum section, the pressure becomes lower than the vapor pressure, there is the formation of bubbles and therefore a possible erosion of both the shutter and the seat. Furthermore, since there is a large amount of bubbles, the flow rate does not increase and a sort of clogging is created.

After this point, the velocity decreases while the section and pressure increase.

As described above, if the pressure increases enough to exceed the vapor pressure, the bubbles implode. If, on the other hand, the outlet pressure still remains lower than the vapor pressure, the liquid/vapor mixture remains present even downstream of the valve.

Typically, valves subjected to cavitation are characterized by a very irregular, rough and pitted surface.

In the picture it is possible to see the difference of pressure inside a valve in specific simulated conditions that can generate cavitation phenomena (high flow speed and limited opening of the valve).

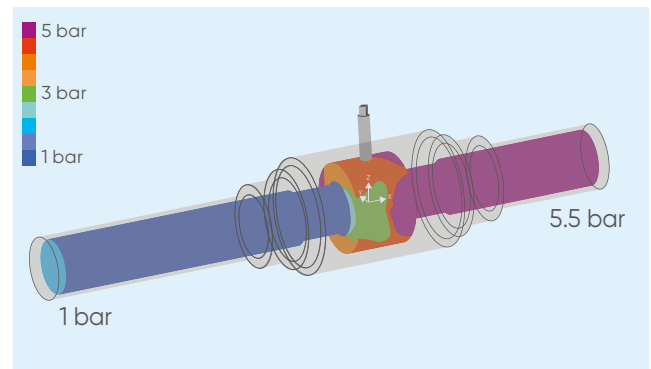

To prevent this phenomenon from occurring, it is necessary to carry out a careful planning of the system, taking into consideration several factors:

- the vapor pressure of the process fluid: in this way a valve is chosen in which the pressure, even in the minimum section, is greater than the vapor pressure;
- the position of the valve: the further upstream the valve is, the lower the risk that the pressure drops below the steam pressure;
- leaks with the valve closed: it is necessary to avoid leaks occurring when the valve is closed as the fluid in this case, rapidly passing from a high pressure to a low pressure area can be subject to cavitation;
- flow rate and material: cavitation problems increase with the amount of flow and the damage on the valve depends on the resistance of the material.

In case of assistance and evaluation please contact your Aliaxis sales representatives.

2.5 Valve selection and features

Valves have the function of intercepting or regulating the flow of fluids in the pipes as described in the previous chapter.

These devices are made of different plastic materials and are realized in several models according to the type of applications in which they are used, therefore it is extremely important to choose the most suitable one in relation to the characteristics of operation.

In this chapter we try to help to select the correct valve according to the kind of fluid, the mechanical stress that may occur in the system (like vibrations and thermal expansion), the safety and security reasons, or depending on whether you want to have an easy installation or a very accurate regulation.

2.5.1 Fluid characteristics

The characteristics and condition of the process fluid should be carefully defined to select the correct type of valves, in fact clean fluids generally permit a wide choice of valve types, whereas for dirty fluids the choice is restricted.

In particular, clean service identifies fluids free from solids or contaminants, such as air, nitrogen and other manufactured gases, potable and demineralised water, steam, lube oil, diesel oil, methanol, and most dosing and injection chemicals. These fluids are generally less damaging to valves resulting in long term performance and reliability.

Dirty service instead identifies fluids with suspended solids that may seriously impair the performance of valves unless the correct type is selected; they may be further classified as generally abrasive or sandy.

Abrasive service identifies the presence of abrasive particulate in piping systems including pipe rust, scale, welding slag, sand, catalyst fines and grit.

Abrasive conditions are commonly found during construction, flushing, and line clearing operations.

Sandy service is a term identifying severe abrasive and erosive conditions occurring in oil and gas production in which formation sand is carried through from the well.

Severe erosion of valve trims and bodies may occur if pressure drop and velocity is high.

At this point, it is necessary to remember that ball valves are recommended for clean service only, while are unsuitable for dirty fluids, otherwise the accumulation of solids around the ball will cause the erosion of the material.

On the other hand, to handle corrosive, erosive, dirty services diaphragm valves are ideal.

Various types of diaphragms made in EPDM, FKM or PTFE can be equipped according to the final applications, such as chemical plant treating slurries, viscous or chemically aggressive fluids.

Obviously these valves have consumable components subjected to wear and fatigue so maintenance may be required if a regular use is needed.

Butterfly valves can be applied to convey both clean and dirty fluids according to different positions of the valve, for example:

- to convey clean fluids the valve can be positioned with the stem perpendicular to the pipe support plane without any risks;
- to convey dirty fluids or fluids with sediments it is suggested to position the valve with the stem parallel to the pipe support plane to avoid sediment collection at the base of the disc position or with the stem inclined at an angle of 45° , as shown in the next picture.

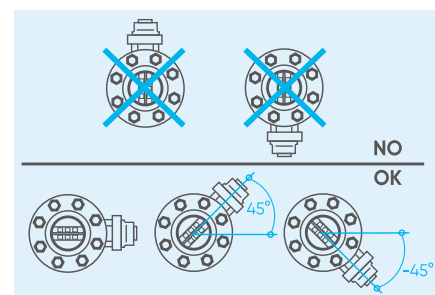

Moreover, to limit the passage of solid particles present in the fluid, it is advisable to use FIP RV impurity collector: inside there is an easily removable filter in order to facilitate cleaning or replacement.



For some applications in which volatile media are used, such as sodium hypochlorite or hydrogen peroxide, ball valves can be equipped with a vent hole, which is simply designed as a pit through the side of the ball.

When a ball valve is closed, medium gets trapped in the cavity of the sphere, but if the valve is not often used, this trapped fluid begins to age and it can start to decompose. This phenomenon is accelerated in case the valve is exposed to heat sources.

For example when sodium hypochlorite breaks down it begins to give off gas with connected volume expansion: this can create pressure in the cavity of the ball which can lead to valve failure or explosion.

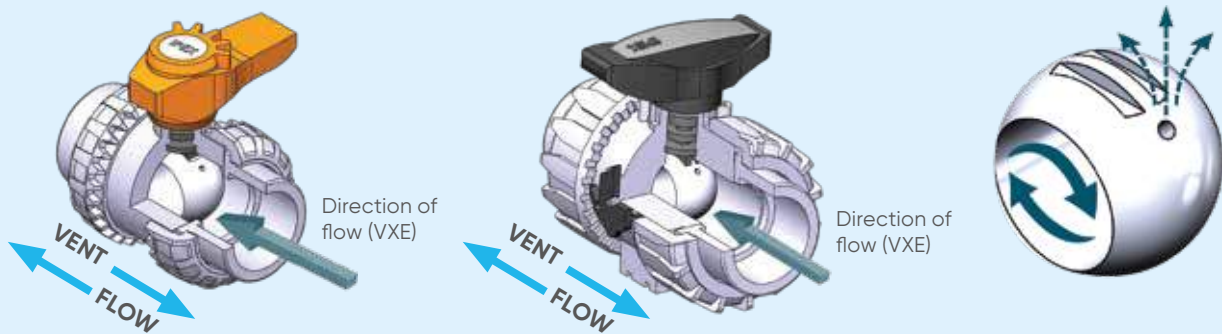

In this dangerous situation, when the valve is in the close position the fluid that would have been trapped is allowed to flow freely in and out through the vent hole, as can be seen in picture.

To obtain this kind of feature in your valve please contact your Aliaxis sales representatives.

2.5.2 Mechanical stress and vibrations

When choosing a valve, it is always necessary to take into account common mechanical problems that can occur within the systems, such as stress, thermal expansion, vibrations, which affect the correct functioning of the valves themselves.

In order to minimize and resolve these issues, FIP has designed several systems and special features our valves are equipped with.

The main ones are described below.

DUAL BLOCK® System



DUAL BLOCK® is a patented system developed by FIP that allows you to lock the union nuts of the union ball valves in a preset position.

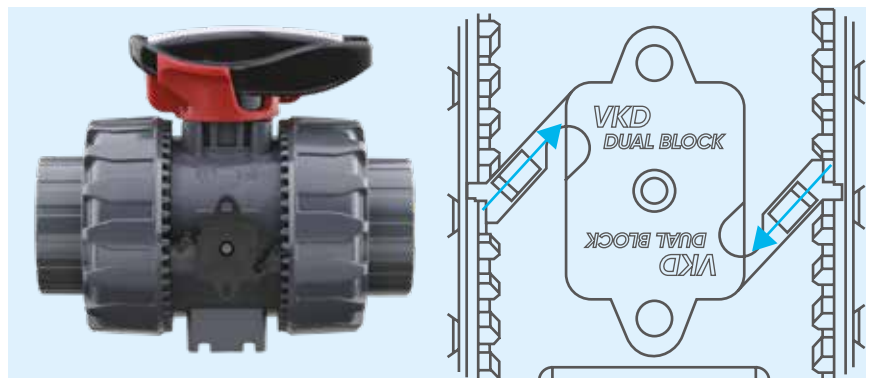

The locking-nut device allows only the clockwise rotation of the nut on installation and prevents anti-clockwise rotation.

When the valve has been installed and the nuts have been tightened, the DUAL BLOCK® system prevents the accidental loosening of these: the FIP VKD valve is particularly suited to hard working conditions where vibrations, pressure variations or thermal expansions may affect the performance of ordinary true union valves.

The DUAL BLOCK® system allows installation of plastic true union valves in chemical plants and dangerous fluids transportation lines, combining the flexibility and the simple mounting of a unionized valve with the intrinsic safety of a rugged one piece body flanged valve.

For pipes with a nominal diameter lower than 63 mm, dismantling the valve from the pipeline is simple, just disengage the DUAL BLOCK® system, remove it and loosen the nuts by turning them anti-clockwise.

When nominal diameter is between 65-100 mm, as the following picture shows, by turning the button to the left and orienting the arrow on the padlock when opened, the DUAL BLOCK® is put in the release position: the valve nuts are free to rotate clockwise and counter clockwise.

By turning the button to the right and orienting the arrow on the closed padlock, the DUAL BLOCK® is placed in the locked position: the valve nuts they are locked in a fixed position.



DIALOCK® System

The DIALOCK® system consists of an innovative control handwheel equipped with a patented, immediate and ergonomic handle locking mechanism, which allows you to lock any adjustment position reached.

Handwheel and cover are made of PP-GR with high mechanical and chemical resistance: this guarantees total protection and isolation of all the internal metal parts from contact with external agents.



By simply lifting the handwheel once the desired position is reached, the handle is blocked, as shown in picture of FIP DK diaphragm valve.



To unlock simply press the handwheel down.

SEAT STOP® System

FIP VKD and TKD valves used the patented SEAT STOP® system.

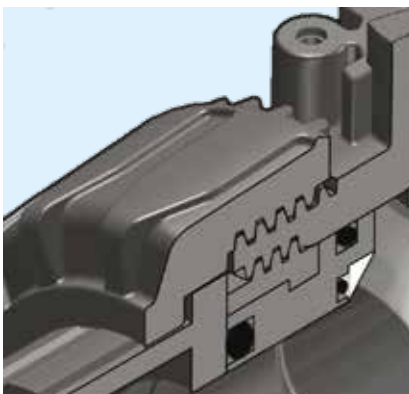

The ball seat carrier is manufactured in two pieces, one external threaded piece for assembly and one internal piece where the seals are located.

This seat carriers allows to make little microadjustments to the valve support.



As any accidental loosening of the ball carrier is not possible, the radial removing of the valve body can be done in full safety.



The ball carrier can only be removed through the special tool located into the handle.

Stem made of 316 Stainless Steel

FIP FK butterfly valves, as the one shows in the next picture, are characterized by AISI 316 Stainless Steel stem.

In this valve the stem is completely isolated from the fluid, so Stainless Steel does not come into contact with the liquid.

The main advantages of using stainless steel in the stem over other materials consist in better mechanical performance.



2.5.3 Safety

To prevent safety problems within a plant, especially when using hazardous fluids, it is advisable to use labelling systems or valves that have a chance to identify the treated fluid or the operating conditions.

The main features for which a valve can be chosen to counter safety problems are the following ones.

Labelling System

It is often necessary to customize a valve by labelling or tagging it: this system allows the creation of special labels to be inserted into the handle.

This makes it extremely easy to identify easily the valve on the system according to specific needs, for example the function of the valve in the plant or the fluid conveyed for safety reason, but also specific information for customer service, such as the customer name or date and place of installation.



The specific LCE module is composed of a transparent rigid UPVC cap resistant to water, represented in the picture by letter **A**, and a white label holder of the same material, represented by letter **B**.

The tag holder can be easily removed to be used for self labelling on its blank side.

The module LCE EASY FIT® is available for FIP ball valve models VEE, VXE, SXE, for FIP butterfly valve models FE, FK and for large bore FIP VKD DUAL BLOCK® ball valves.



FIP DK diaphragm valve is equipped with a customisation plate that can be customized according to specific needs.



The valve body is set up for the installation of an identification tag.

Double O-Ring on stem

Our industrial ball valves, for example VKD, VXE and VKR are characterized by a high surface finish stem with double O-Ring and double connection key to ball (only for VKD and VKR). The double O-Ring is made in EPDM or FKM.

The FKM seal is renowned for its resistance to high temperatures, while the EPDM seal for its high performance in hydraulic sealing.

DUAL BLOCK® System

Since this system allows only the clockwise rotation of the nut on installation and prevents anti-clockwise rotation, it could be useful when hazardous fluids are treated to prevent possible losses.

To have more information refer to the selection of the valve according to mechanical stress.

2.5.4 Security

To prevent problems related to security, such as tampering or unwanted interference, from occurring in the system, it is suggested to look for a valve with the following characteristics.

DIALOCK® System

This system can be very useful, since once the desired position of the handle is reached, simply lifting the handwheel the handle is locked.

To get more information it is recommended to look for the selection of a valve according to mechanical stress.



Lock

Movement of FIP VKD ball, FK butterfly, DK diaphragm valves can be avoided by a lock next to the handle.

2.5.5 Easy installation

EASY FIT® System



FIP and Giugiaro Design designed and developed EASY FIT® system for VEE and VXE valves.

It is an innovative true union gear ball valve introducing an advanced method of installation for a long trouble free service.

The principle of the bevel gear pair has been applied to design this mechanism that controls the rotation of the union nuts during the valve installation.

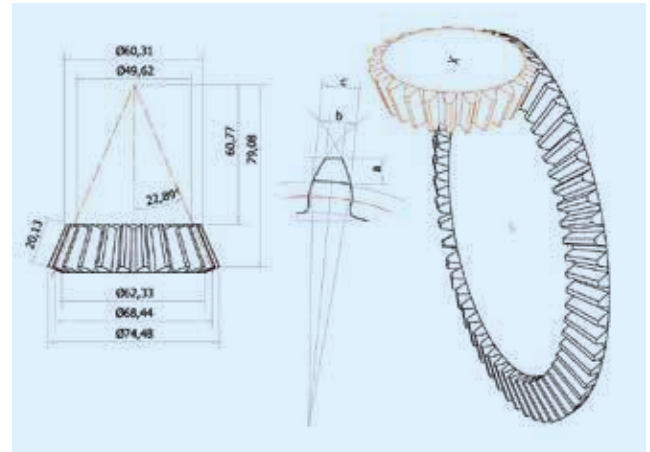

Thanks to the reducing ratio of the torque, the valve union nuts are easily and safely tightened or un-tightened without over stressing the threaded components of the valves and the pipeline jointing fittings.

The EASY FIT® mechanism can be very useful in a wide range of pipeline layout, especially in narrow spaces, because the stem of the valve is the pivot of the bevel gearing.

The multifunctional handle is the powering driving tool to be placed on the stem axis and used to turn the union nuts in order to tighten or untighten them.

It is the best solution to carry out maintenance operations in narrow spaces with limited access to the valve location. It is always recommended to grant a gradual compression of O-ring seals and to avoid nonspecific tools causing union nut damaging or fluid leakage.

The handle can also be used to adjust the ball seat holder as shown in these pictures.



FIP has also extended this valve line realizing the completion of the range with ball valves with DN 65-100.

In this case the handle is composed by a central hub fixedly couples to the valve stem, by a double spoke handle that can be released from the hub with a simple operation and by a hooked insert housed in the handle which transforms it into a key for union nuts tightening.

Again the use of the handle guarantees a perfect hydraulic seal and prevents the accidental damage of the union nuts that can be caused by the use of non specific tools.

In particular, the handle, after being released from the hub as shown in the figure, can be transformed into a key for tightening or unscrewing the ring nuts.

To do this it is necessary to remove, flip and engage the insert housed inside it in the appropriate seat.



The tool so composed is extremely rugged and light at the same time thanks to the finite element method design (FEM) offering an excellent ergonomic grip.

This insert design engages perfectly on the external profile of the union nuts with a secure grip allowing to exercise a high torque without damaging the nuts in any way.



2.5.6 Accurate regulation

VKR DUAL BLOCK® valve

FIP VKR DUAL BLOCK® valves combine typical full bore VKD ball valve reliability and safety along with an accurate, repeatable flow regulation function which meets the most extreme requirements of industrial applications.

The patented ball design provides linear flow regulation throughout its range of operation even when the valve is open just a few degrees and guarantees minimum pressure losses.

One of its main characteristic is the handle fitted with disc showing valve position on a graduated scale of 5° for an accurate and easy reading, as can be seen in the picture.



2.6 Air release from pipelines

Trapped air inside a pipeline could sometimes create a problem. In this chapter, we will discuss everything you need to be aware of the causes of trapped air and how to avoid it.

2.6.1 Entrapped air: sources and causes

Entrapped air in pressure pipes is a topic widely researched and discussed. Many designers are concerned about it, need to understand the full consequences of the issue or the methods used to mitigate the hazards involved with trapped air.

The behavior of air in a piping system is not easy to analyze, but the consequences can be catastrophic.

There are many potential sources for air in pipelines and the sources are usually multiple in any given system. The most likely source occurs during filling, either initially or when refilled after drainage. In some systems, air re-enters each time the pumps are shut off as the pipelines drain through low lying sprinklers or open valves.

Air is often introduced at the point where water enters the system; this is an especially common problem with gravity fed pipelines but may occur with pumped systems as well.

Even water pumped from deep wells may be subject to air entering from cascading water in the well.

A less obvious source of air comes from the release of dissolved air in the water, due to changes in temperature and/or pressure. The quantities may be small in this case, but accumulations over time can create problems.

It is also common for air to enter through mechanical air release valves or vacuum breakers when the pressure drops is below atmospheric pressure: this can occur during pump shutdown or during negative surges.

Air in a piping system tends to accumulate at high points during low flow or static conditions. As the flowrate increases, the air can be forced along the pipeline by the moving water and may become lodged at the more extreme high points where it reduces the area available for flow. Thus, these pockets of air cause flow restrictions that reduce the efficiency and performance of the system.

As an air pocket grows, the velocity past that point increases until eventually the air is swept on toward an outlet. While line restrictions are problems, a more serious situation can occur when air is rapidly vented from the system under pressure.

To provide an indication, water is about five times denser than air at 7 bar so when a pocket of compressed air reaches an outlet, such as a sprinkler head or air release valve, it escapes very rapidly. As it escapes, water rushes in to replace the void.

When water reaches the opening, the velocity suddenly decreases, at the above-mentioned condition of 7 bar air escapes about five times faster than water.

The result is similar to instantaneous valve closure, except that the velocity change can far exceed the normal flow velocity in the pipeline. This behavior tested at Colorado State University, United States, where it observed that the pressure surges up to 15 times the operating pressure when entrapped air rapidly vented under pressure. Such pressure surges can easily exceed the strength of the system components and even at lower magnitudes, repeated surges will weaken the system over time.

2.6.2 Dealing with entrapped air

Obviously, the best way to reduce problems caused by entrapped air would be to prevent it from entering the system. Precautions should be taken to eliminate air entrance. When systems are filled, either initially or after draining for winterization or repair, they should be filled slowly, at a velocity of 0.3 m/s or less, and the air should be vented from the high points before the system is pressurized. Even with these precautions, some air can remain in the system.

To deal with this remaining air or newly admitted air generated by the process itself, one or more continuous-acting air relief valves should be incorporated in the line. One solution would be to use manual vent valves such as ball valves. This solution is not ideal as strategically positioned manual vent valves can deal with entrapped air at startup but will not deal automatically or effectively with recurring air entrapment problems. In addition, manually operated vents will inevitably lead to spills potentially resulting in site contamination or operator injury (depending on the carried media).

To ensure an effective means of dealing with entrapped air, continuous acting valves should be the preferred choice. Continuous-acting valves contain a float mechanism which allows the air to vent through a small orifice, even when the line is pressurized.

Also available on the market are combination air-release/vacuum braking valves. These products have dual functions. For example, when a tank is being filled, the entrapped air is allowed to escape, and the liquid is allowed to rush in unopposed by air pockets. When the process is reversed, during the draining of a tank, the valve shutting mechanism opens the valve allowing air to rush in and replace the volume previously held by the liquid, thus preventing the formation of a potentially damaging vacuum.

In Aliaxis, we offer the FIP VA Air Release valve, a piston style air-release/vacuum breaker valve in various sizes. It is important to note that the open and close functions of this 'smart' valve are controlled by media and not pressure as in other air-release valves.

This feature provides several advantages: no minimum pressure or vacuum is required to either open or close the valve, thus guaranteeing responsiveness in any and all conditions while eliminating the potential for spillage.

It is necessary to remember that FIP VA valve cannot be adopted in case of pressurized gas.

The flow rate through the valve is reported in the table.

DN	VA FIP
15	12 Nm ³ /h
20	23 Nm ³ /h
25	45 Nm ³ /h
32	70 Nm ³ /h
40	90 Nm ³ /h
50	345 Nm ³ /h



2.7 Piping system design for vacuum condition

In some cases, piping systems are exposed to external pressure, usually called buckling pressure. This happens for example when the installation is submerged in water, when systems are buried or are adopted for vacuum, as suction pipes.

The mechanical load at absolute vacuum corresponds to a differential partial vacuum of 1 bar, this means that the pressure on the pipe's inner wall is 1 bar less than the pressure on the outer wall at standard atmospheric pressure.

The buckling pressure can be calculated with this formula for cylindrical pipe:

$$p_k = \frac{10 * E_c}{4 * (1 - \mu^2)} * \left(\frac{t}{r}\right)^3$$

where:

p_k = critical buckling pressure (bar)

E_c = creep modulus (N/mm²)

μ = Poisson's ratio, usually for thermoplastic for 25 years of service life $\mu=0,4$

t = wall thickness (mm)

r = medium pipe radius (mm)

The buckling tension can be calculated as follows:

$$\sigma_k = p_k * \frac{r}{t}$$

where:

σ_k = buckling tension (bar)

p_k = buckling pressure (bar)

r = medium radius of pipe (mm)

t = wall thickness (mm)

In these calculations any possible variation related to roundness and eccentricity was not taken into account. Furthermore, of course, only pressurized pipes can be used for systems exposed to external pressure, thinner pipes are not suitable for these conditions

2.8 Piping system design for compressed air

Until now we have dealt with systems that transport fluids, in this chapter we focused on systems that transport gas, in particular compressed air.

What is compressed air

Air is a mixture of gases, which means that it is made up of many gases, mainly of nitrogen (78%) and oxygen (21%) and water vapor, carbon dioxide and other gases (1%).

Compressed air is atmospheric air reduced in volume through a compressor or pump, placed under pressure inside a tank.

To compress air means forcing it into a smaller space, making the molecules move very quickly and bringing them closer to each other: the air, in fact, like the other gases, does not have its own shape but is adaptable to the containment vessel.

The volume occupied by the air depends on the pressure and temperature to which it is subjected according to gas laws.

In particular, Gay-Lussac's first law affirms that the volume of a gas at constant pressure is directly proportional to the absolute temperature of the gas, as follows, considering $p = \text{const}$:

$$\frac{V_1}{T_1} = \frac{V_2}{T_2}$$

Gay-Lussac's second law explains that the pressure of a gas at constant volume is directly proportional to the absolute temperature of the gas.

The formula is the following if $V = \text{const}$:

$$\frac{p_1}{T_1} = \frac{p_2}{T_2}$$

The law governing the relationship between the volume of an ideal gas and the pressure is the Boyle-Mariotte law.

According to this, the volume of a quantity of perfect gas closed in a container, at a constant temperature, is inversely proportional to the absolute pressure.

The formula is as follows considering $T = \text{const}$:

$$p_1 V_1 = p_2 V_2$$

As can be seen in the next picture, a piston pushes the air down in a cylinder: by placing the gas inside a container and subjecting it to a pressure gradually increasing, the volume decreases and consequently molecules get closer to each other with a fast movement.

By combining the three laws of gases together, it occurs experimentally that the relation holds:

$$\frac{p_1}{T_1} V_1 = \frac{p_2}{T_2} V_2$$

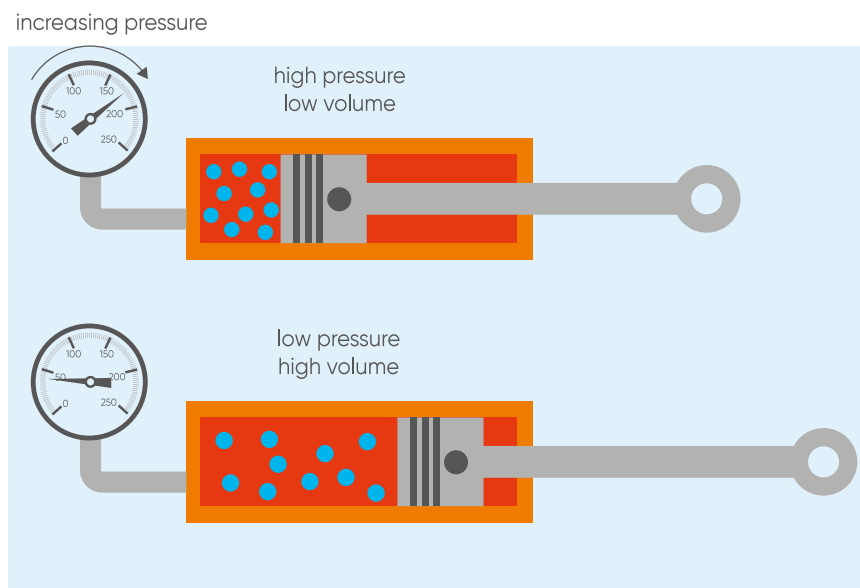

Since the temperature is directly proportional to the kinetic energy, the movement of the molecules due to the compression causes the temperature to increase.

In this way, the energy that is released during compression is equal to the energy required to force the air into a certain space, which is why compressed air is an excellent means of storing and transmitting energy.

It is being used increasingly in manufacturing industries because of its distinct advantages of cleanliness, flexibility, safety and economy of use if compared with other energy sources, such as batteries and steam.

In fact, in applications where the equipment is overloaded, electrical equipment can pose a safety risk, while compressed air tools can be used in various conditions, such as in wet areas.

Compressed air system

A compressed air system must be controlled, regulated, and sized to ensure an adequate volume of air, at a specific pressure and purity.

As regards the design, it is considerably different from designing a non compressible liquid system, because being gases compressible there are more variables to consider.

In particular, air compressed system should take into account current and future demands to maximize the ratio between cost and effectiveness, for example piping pressure drops should be kept to an absolute minimum because they are totally unrecoverable, they are just an energy and financial loss.

Prior to the design project of the system, since from a practical point of view compressed air is never pure but contains contaminants of different nature and physical state, the identity and quantity of these pollutants must be determined to decide what equipment is required to reduce or remove them.

So it is necessary to remember that usually there are these contaminants which influence each other and mix to form compounds:

- **water:** it is present in atmospheric air in the form of water vapor. When the air is compressed, the partial pressure of the water vapor increases, but due to the increase in temperature caused by the compression, there is no condensation; when the air is subsequently cooled, the water condenses, passing to the liquid state. It is necessary to remember that moisture can cause corrosion and damage the final product;
- **oil:** in lubricated compressors, the air inevitably contaminates with oil, but also the air produced by non-lubricated compressors may contain traces of oil from the atmosphere;
- **solid particles:** The solids with dimensions smaller than 10 microns cannot be retained by suction filters therefore they are introduced into the compressed air circuit. This contamination occurs with any type of compressor.

In order to convey compressed gas Aliaxis propose two dedicated product lines: GIRAIR and AIRLINE. In compressed air systems with correct design, two types of pipelines are used: main line and branch lines.

Main line is used to carry the bulk of the compressed air.

If this line is too small air velocity will be very high, so it will be difficult to separate water from air, since much of the condensed vapor running as water along the bottom of the pipe will be whipped up by the fast moving airstream.

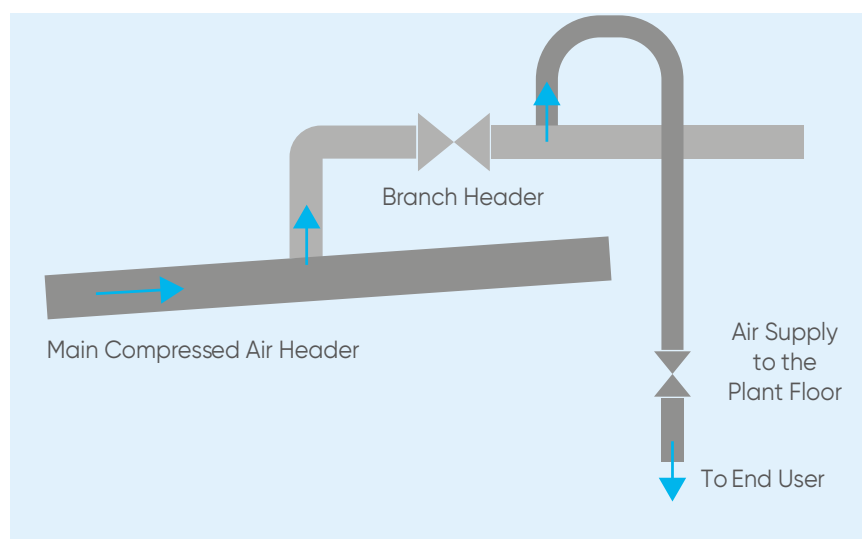

With a large diameter, velocities are lowered, allowing water to collect on the bottom of the pipe while air flows over the top. Therefore, oversizing results in increased initial capital expenditure but larger pipes are advantageous, because they act as a receiver for the air thus reducing the load on the compressor and providing capacity for increased future demand.

In general, for the main distribution line, excessive pressure drops and energy loss can be avoided by restricting air velocity to a maximum of 33 l/min.

On the other hand, branch lines are relatively short in length: since water from condensation is separated in main lines, smaller branches allow for higher velocities and pressure drops.

Here gooseneck fitting is essential because they prevent water from entering the branch line, in fact they draw air from the top of the main line, leaving condensed water on the bottom.



To conclude, to design the system and to determine the correct pipe size the following information is required:

- total flow rate of all air-using devices: it is fundamental to determine the volume of air and pressure range used in each location. Information regarding pressure and flow rate for equipment such as tools can be obtained from the manufacturer. If they are not known, assign some preliminary rates until the specific values can be obtained;
- the maximum working pressure. This is the maximum pressure in continuous service for which the GIRAIR or AIRLINE systems were designed. It depends on the temperature of the fluid transported and/or on the ambient temperature that can be found in the direct surroundings of the installation. Temperature elevations reduce the modulus of the materials used to manufacture the system, which in turn reduces its resistance to hydrostatic pressure. The table below indicates the maximum applicable working pressure for GIRAIR and AIRLINE systems according to different temperatures:

Ambient or fluid temperature	Maximum working pressure
0°C - 25°C	12.5 bar
25°C - 40°C	10 bar

- Duty cycle, that is how much time the individual tool or process will be in actual use for a one-minute period of time;
- leakage and future expansion allowance: leakage is a result of the number and type of connections, the use of disconnects, the age of the system and the quality of the initial assembly process. A well maintained compressed air system will have an allowable leakage rate of 2-5%. It is also necessary to establish any allowance for future expansion: thought should be given to oversizing some components to avoid the cost of replacement at a later date;
- allowable pressure drops for the entire system;
- altitude, temperature and contaminant removal corrections;
- location where adequate space is available for air compressor and ancillary equipment: process, workstation, or piece of equipment that uses compressed air should be located on a plan, and a complete list should be made to simplify record keeping;
- produce a final piping layout and size the piping network: determine the system conditioning requirements for each piece of equipment: this includes the allowable moisture content, particulate size, and oil content. Decide if the system may require conditioning equipment including dryers, filters, lubricators and pressure regulators.

In case of need please contact your Aliaxis sales representatives.



WARNING: Never use UPVC and CPVC with compressed air

Never use compressed air in pipe and fittings made of UPVC and CPVC. Only use UPVC and CPVC materials for water and approved chemicals. This is due to two main reasons:

- When subjected to stresses they cannot withstand, PVC pipes can break, sending plastic splinters flying and causing severe injuries or death.
- When exposed to freezing temperatures, UPVC pipe can become brittle and can shatter much more easily than usual, so compressed gases should not pass through it.
- To convey compressed air, please refer to Girair and Airline systems.

2.9 Selection of flowmeter

To measure flow rate in a pipe is important for various reasons, for example to check the correct functioning of industrial processes or to control energy costs.

To do this, the best way is to install flow monitoring systems that provide accurate and reliable data to support smooth operations, enabling real-time process control and predictive maintenance.

In particular, Aliaxis supplies a complete range of products belonging to FLS which are designed to provide reliable and consistent inputs for a wide range of applications concerning the measurement of flow rate, pH, conductivity and redox potential.

In this chapter we will focus on flow measurement, which can be accomplished by flowmeters. In particular it is possible to find three kinds of them:

- insertion flow sensors;
- in line flow sensors;
- variable area flowmeters.

2.9.1 Flowmeter design

2.9.1.1 Insertion flow sensors

Insertion technology is based on fluid speed meters, installed in a cylindrical straight pipe, and used to measure the local flow velocity (V_m) to calculate the average velocity (V_a) and the volumetric flow rate (Q_v).

These flow sensors are theoretically supported by fluid-dynamic laws applicable to any circular cross section pipe when fully developed turbulent flow is respected, so when Reynold's Number is greater than 4500.

These laws describe the relationship between measured local velocity and average flow velocity, that is expressed through the profile factor (F_p) according to the following formula:

$$F_p = \frac{V_a}{V_m}$$

where:

F_p = profile factor

V_a = average velocity (m/s)

V_m = local flow velocity (m/s)

Using the above mentioned factor:

$$Q = \frac{V_a * D_i^2}{4} = \frac{F_p * V_m * D_i^2}{4}$$

where:

Q = flow inside the pipe (m^3/s)

V_a = average velocity (m/s)

V_m = local flow velocity (m/s)

D_i = internal diameter of the pipe (m)

The suitable measuring point for the flow velocity is called "critical position": the velocity sensor is inserted in a peculiar point where the local velocity corresponds to the average velocity ($V_a = V_m$ and $F_p = 1$). This location corresponds to the 12% of internal diameter.

Main features of the insertion technology are:

- all the insertion technology flow sensors are velocity-based flow measurement devices;
- the installation typically requires only a small hole in the pipe for sensor perpendicular mounting;
- sensor's dimensions are not pipe size specific since they are independent from pipe cross section.

There are mainly three different type of insertion flow sensor:

Paddlewheel sensor

This flow sensor consists of a transducer and a ECTFE five-blade open cell paddlewheel fixed on a ceramic shaft that is orthogonal to the flow direction.

The sensor is installed into the pipe using a wide range of insertion type fittings supplied by FLS.

An example of paddlewheel sensor is shown in the next picture.

The paddlewheel is equipped with a permanent magnet integrated into each blade.

As the magnet passes close to the transducer a pulse is generated, therefore when liquid flows into the pipe, the paddlewheel is set in rotation producing a square wave output signal.

The frequency is proportional to the flow velocity according to the following equation:

$$Q = \frac{f}{K_{factor}}$$

where:

Q = flow rate (l/s)

f = frequency (1/s)

K factor (1/l) represents the number of pulses produced by a sensor per liter of fluid measured, it is the conversion value which has to be fixed in order to convert sensor output (frequency) to a flow rate.

The K-factors present in the tables on the FLS catalogue refer to water at room temperature, but obviously if sensors are applied to measure a different liquid it is necessary to carry out a calibration on site.

As regards maintenance, since rotor and shaft are in direct contact with the fluid it is necessary to pay attention to which fluid they come into contact with.

Because every fluid has different characteristics, it is difficult to estimate the life expectancy of these components: it is therefore necessary to refer to chemical compatibilities of each component in contact with the chemical substance in order to choose the most suitable material.

In addition, it is suggested to avoid using paddlewheel flowmeters for measuring very dirty fluid, liquid containing fibers, or liquids with rocks or pebbles that could break or damage the rotor or the axle.

Solids could affect sensor response also modifying friction of shaft.

In the event that it is necessary to use a paddle wheel with fluids containing solids, a procedure for cleaning the wet parts must be periodically planned, since a neglected paddlewheel will in time have degraded accuracy: for this cleaning procedure it is recommended to use detergents or chemicals compatible with wet materials.

Magmeter sensor

This sensor is based on Faraday's law since a voltage is induced in an electrical conductor when it moves in a magnetic field.

An example of magmeter sensor is shown in this picture.

A coil mounted into sensor body generates a magnetic field perpendicular to the flow direction: this magnetic field and the flow velocity induce a voltage between the electrodes, which is directly proportional to the flow velocity.

The voltage is converted into a flow proportional 4-20 mA output signal or frequency output signal.

As regards maintenance, in general magmeter flow sensor does not need a specific one.

In case magmeter is used to measure a very dirty liquid it can be suggested to clean periodically the device with a cloth slightly dampened with water or a liquid compatible with the materials of the device and cloth, since dirty electrodes may cause measurement inaccuracy.

Do not use abrasive materials to take maintenance.



Hot tap flowmeter

The use of hot tap instrumentation is suggested for installation in pressurized pipes and when it is impossible to stop the flow rate into the pipeline, so for example in water distribution.

Hot tap flowmeter has not moving mechanical parts, it can be applied for the measurement of dirty liquids so long as they are homogeneous and conductive, in fact it is available for the magmeter sensor only.

The sensors designed for this installation are suitable also for pipes with a diameter larger than the maximum covered by traditional sensors (typically DN 600) and have to be combined with hot tap fitting only.

This picture shows an example of hot tap flowmeter.



2.9.1.2 In line flow sensors

FLS can supply two different kinds of in-line sensors for low flow rates to cover different applications according to operating range and specific viscosity of liquid.

These two kinds of in-line sensors with different characteristics, but both of them have to be applied for the measurement of solid-free liquids as movement parts are present.

Ultra Low Flow (ULF) sensor

This in-line flow sensor consists of a transducer and a five-blade paddlewheel.

The paddlewheel is equipped with a permanent magnet integrated into each blade. As the

magnet passes close to the transducer a pulse is generated, so when liquid flows into the sensor body, the paddlewheel is set in rotation producing a square wave output signal.

ULF sensor can be used with every kind of aggressive and solid-free liquids and it can be fixed to flexible or rigid pipes via gas threaded process connections.

This picture shows an example of ULF sensor.

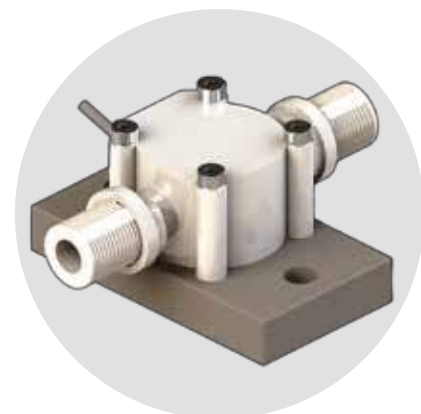

Oval Gear sensor

This in-line sensor body contains two oval gears set into rotation by a flowing fluid.

The two gears are meshed at 90° to define a fixed fluid volume pumped out every rotation.

Two permanent magnets are positioned into each gear and a hall effect sensor detects the magnetic field generating a square wave signal output with frequency proportional to the number of fluid volumes pumped out.

The Oval Gear sensor has been designed following the main industrial application requirements, such as high mechanical resistance and reliable performances, it is suitable to measure a wide range of viscous solid-free liquids with a very high accuracy and repeatability.

The sensors can be fixed to flexible or rigid pipes via gas threaded process connections. The construction materials, ECTFE or PP or Stainless steel, provide high strength and chemical resistance.

This picture shows an oval gear sensor.



As for the fluids that inline sensors can work with, it should be remembered that obviously abrasive or dirty liquids can potentially damage the sealing surfaces, bearings and sensor obstruction, so a filter may be required to remove the dirty.

As these types of instruments are mainly used in dosing systems, aggressive chemical solutions are measured very frequently.

Take care of the following cases:

- chemicals may crystallize if left in the sensor for a long time without flow, so it is strongly recommended to plan a sensor cleaning in case irregular use is required. Water and other solutions compatible with the wet material and the chemical being measured can be used for the cleaning procedure;
- Chemicals may release gases, so it is strongly advised to pay attention to this issue, especially during the period of inactivity, making sure that gas bubbles are removed when using in-line sensors.

For the sensors of the oval gear family, the flow measurements made with the bubbles present will be higher than the real flow of the liquid because the volumes of the bubbles will be measured as if they were a volume of liquid.

For sensors of the ULF family, flow measurements made with the gas bubble are not accurate as this presence produces turbulence in the sensor measurement chamber.

In the event that the viscosity of the operating fluid is far from the calibrated liquid (water), it may be necessary to recalibrate the sensor itself to fix the correct k-factor as the different amounts of slip exhibited by different fluids can cause measurement errors.

2.9.1.3 Variable area flowmeters

Variable area flowmeter is one of the oldest and mature principles in flow measurement with a simple design: the traditional method to measure the flow rate involves the suspension of a float in a conical tube, narrower on the bottom and that gradually widens upwards.

An example is shown in the picture on the right.



In variable area flowmeter the fluid flows from bottom to top or from left to right, in the meantime the float is lifted by the force of the flow, as can be seen in the picture.

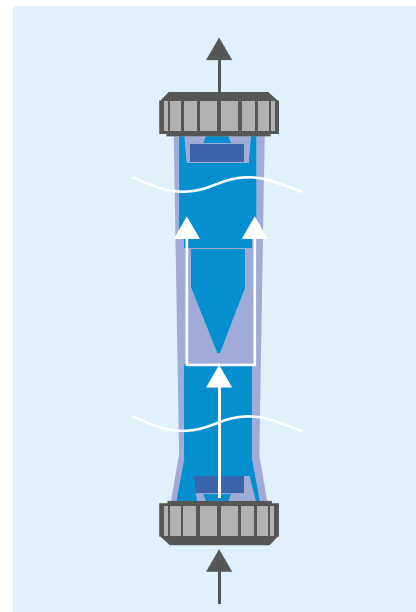

The flow rate can be read when the float stops in the area where the upward force caused by the flow and the downward force caused by the weight of the float are equalized.

Commonly, the conical tube is manufactured with transparent materials calibrated for the flow in such a way as to read the measurements directly from the tube.

The flow rate can then be read on the scale at the position of the float, which therefore represents the instantaneous flow.

To facilitate reading the flow, the maximum and minimum limit values can be adjusted on the flowmeter by means of the red flow indicators provided, as shown in the picture.

To get a correct reading it is necessary to have the float at eye level.

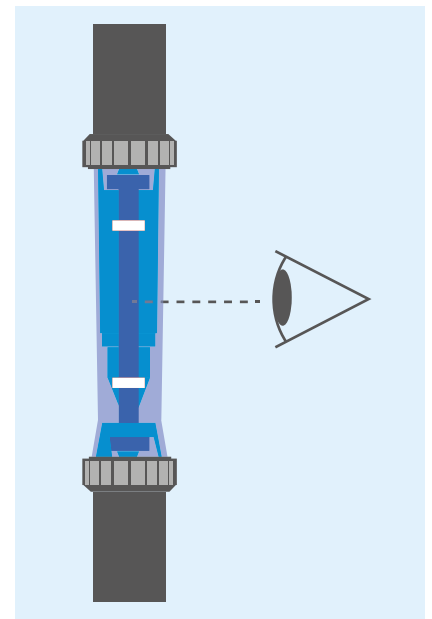

To conclude, the following table shows the conversion values of speed into flow rate (l/s).

Velocity (f/s) = (Flow Rate (l/s) * 1273.2) / D _i ²										Flow Rate (l/s) = (Velocity (m/s) * D _i ²) / 1273.2					
Velocity															
ft/s		0.16	0.33	0.5	0.7	1.6	2.6	3.3	6.6	9.8	13.1	16.4	20	23	26.2
m/s		0.05	0.1	0.15	0.2	0.5	0.8	1	2	3	4	5	6	7	8
D [mm]	DN [mm]	Flow Rate l/s													
20	15	0.01	0.02	0.03	0.04	0.09	0.14	0.18	0.35	0.53	0.71	0.88	1.06	1.24	1.41
25	20	0.02	0.03	0.05	0.06	0.16	0.25	0.31	0.63	0.94	1.26	1.57	1.89	2.20	2.51
32	25	0.02	0.05	0.07	0.10	0.25	0.39	0.49	0.98	1.47	1.96	2.45	2.95	3.44	3.93
40	32	0.04	0.08	0.12	0.16	0.40	0.64	0.80	1.61	2.41	3.22	4.02	4.83	5.63	6.43
50	40	0.06	0.13	0.19	0.25	0.63	1.01	1.26	2.51	3.77	5.03	6.28	7.54	8.80	10.05
63	50	0.10	0.20	0.29	0.39	0.98	1.57	1.96	3.93	5.89	7.85	9.82	11.78	13.74	15.71
75	65	0.17	0.33	0.50	0.66	1.66	2.65	3.32	6.64	9.96	13.27	16.59	19.91	23.23	26.55
90	80	0.25	0.50	0.75	1.01	2.51	4.02	5.03	10.05	15.08	20.11	25.13	30.16	35.19	40.21
110	100	0.39	0.79	1.18	1.57	3.93	6.28	7.85	15.71	23.56	31.42	39.27	47.13	54.98	62.83
125	110	0.48	0.95	1.43	1.90	4.75	7.60	9.50	19.01	28.51	38.01	47.52	57.02	66.53	76.03
140	125	0.61	1.23	1.84	2.45	6.14	9.82	12.27	25.54	36.82	49.09	61.36	73.63	85.91	98.18
160	150	0.88	1.77	2.65	3.53	8.84	14.14	17.67	35.34	53.02	70.69	88.36	106.03	123.70	141.38
200	180	1.27	2.54	3.82	5.09	12.72	20.36	25.45	50.90	76.34	101.79	127.24	152.69	178.13	203.58
225	200	1.57	3.14	4.71	6.28	15.71	25.13	31.42	62.83	94.25	125.67	157.08	188.50	219.92	251.34
250	225	1.99	3.98	5.96	7.95	19.88	31.81	39.76	79.52	119.29	159.05	198.81	238.57	278.33	318.10
280	250	2.45	4.91	7.36	9.82	25.54	39.27	49.09	98.18	147.27	196.36	245.44	294.53	343.62	392.71
315	280	3.08	6.16	9.24	12.32	30.79	49.26	61.58	123.15	184.73	246.31	307.89	369.46	431.04	492.62

2.9.2 Flowmeter installation

As described in design part, there are three ways to measure the flow inside a system:

- insertion flow sensors for high flow and main piping;
- in line flow sensors for low flow and chemical dosing;
- variable area flowmeter.

2.9.2.1 Insertion flow sensors

Since these sensors must be inserted inside the pipe, obviously it is very important to decide their correct placement to get an accurate and reliable reading: in particular it is necessary to check that, in that specific location, the pipe is completely full at every time and flow velocity is uniform.

If the pipe is not full the flow meter will give inaccurate reading even if the sensor is always completely submerged: sensor will make the flow rate calculation on the assumption that the pipe is full, leading to overestimation of the flow.

As regards velocity, since flow meters measure the velocity of the liquid, this should be uniform across the entire cross section of the pipe in the location of the sensor.

To select the best location in the pipeline for paddlewheel and magmeter flow sensor it is suggested to look at the following pictures representing the six most common installation configurations.

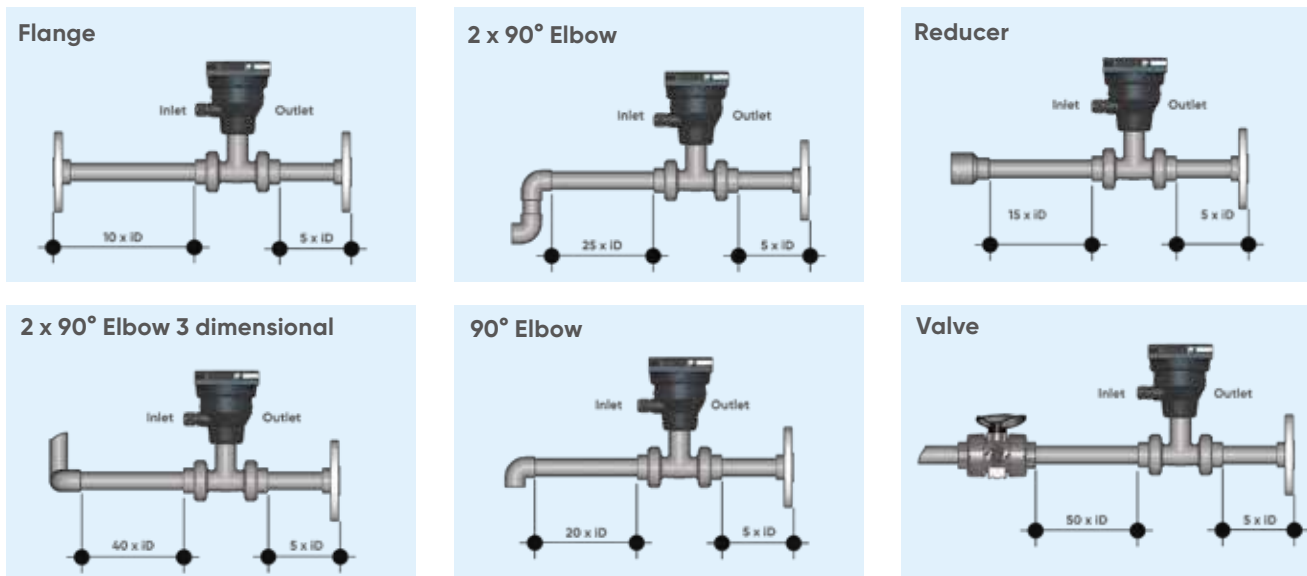

To ensure that the pipe is always full it is important to check the next pictures, in fact, as written before, for a correct measurement the sensor cannot be exposed to air bubbles at any time.

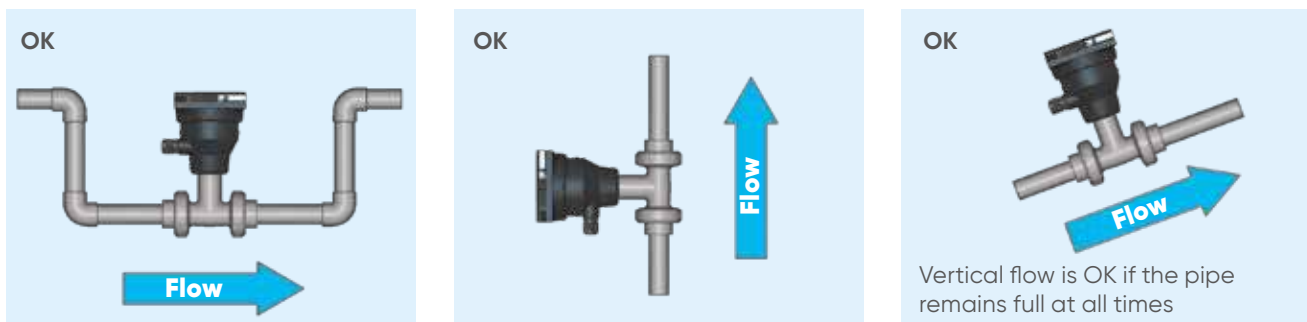

For this reason the installations in the following pictures should be avoided unless you are absolutely sure the sensor is not exposed to air bubbles.

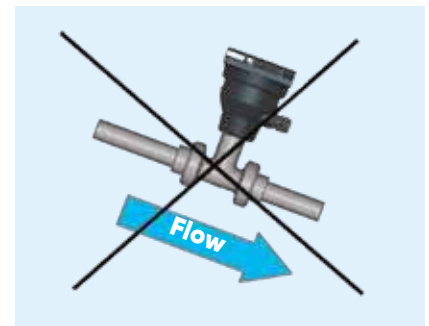
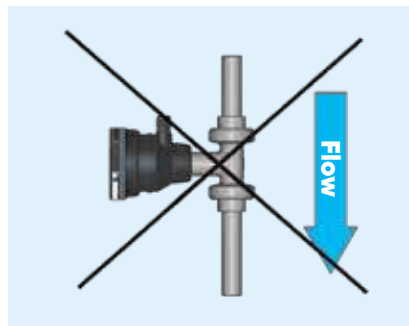
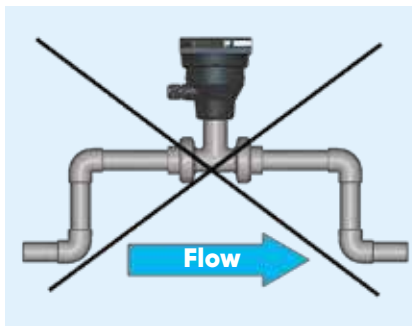

In gravity-flow systems the connection to the tank must be designed so the level does not drop below the outlet: this to avoid pipe to draw air in from the tank causing a inaccurate measurement of sensor, as shown in next picture.

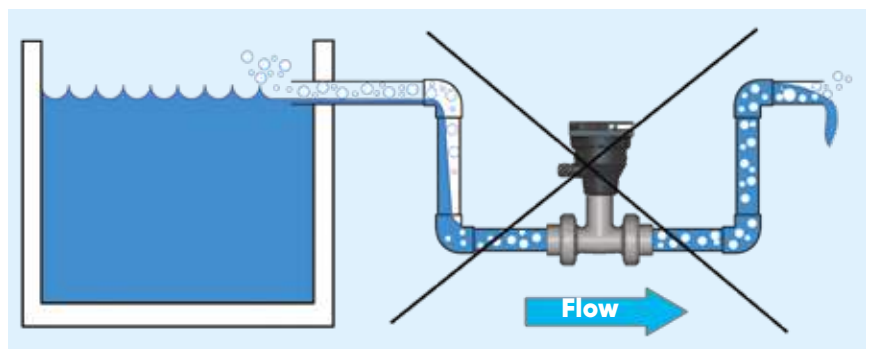

In addition to the location of the sensor, it is necessary to give some guidelines about the position of the measuring part of the sensor, that is the rotor for paddlewheel and pins for magmeter.

This should be positioned at 12% of the internal diameter where, basing on insertion theory, average velocity can be measured.

The reading accuracy can be affected by air bubbles, sediments and for paddlewheel friction between shaft and bearings.

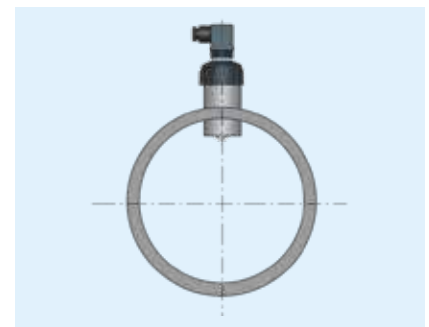
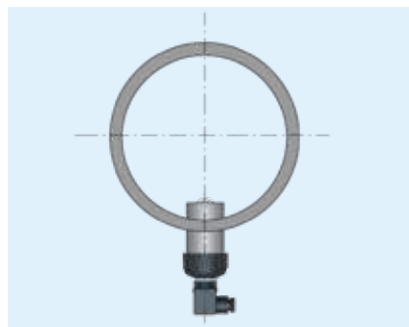
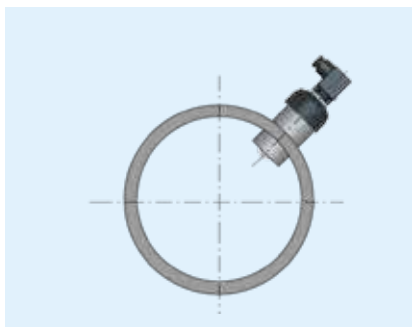

To avoid these problems some mounting positions for horizontal pipe runs can be suggested: for example to avoid air bubbles and sediments the position to get the best performances in at 45°, as shown in this picture.

It is suggested to do not mount the sensor on the bottom of the pipe, as shown in the picture, as there could be the presence of sediments.

These considerations are valid both for paddlewheel and magmeter sensors. In addition, paddlewheel sensor do not have to be mounted at 90° otherwise friction can affect measurement. As regards installation in a vertical pipe runs, it can be done fixing any orientation: upward flow is preferred to ensure full pipe. To have more information, please refer to EN ISO 5167-1.

2.9.2.2 In line flow sensors

In-line flow sensor can be installed both horizontally or vertically, although horizontal flow is preferred, because a non horizontal installation may cause a greater error in the lower part of the measurement range.

Anyway a positioning with a slightly tilt angle is suggested in case bubbles air could be present, as shown in the next picture.

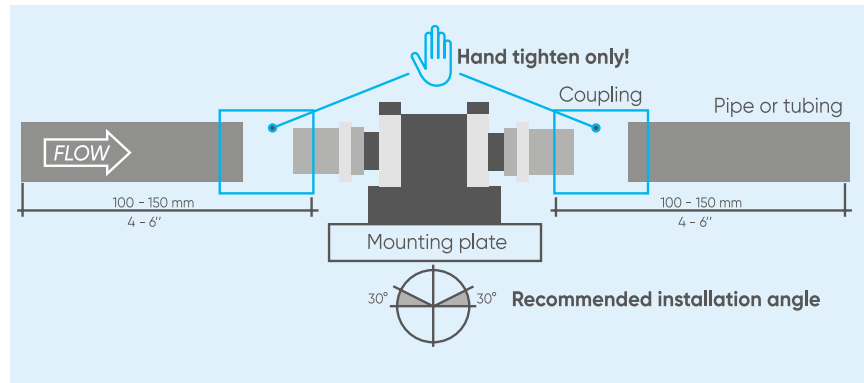

It is suggested to install the sensor with the arrow pointing the direction of the flow, maximize distance between sensor and pump and not install the sensor immediately downstream of valves, elbows or any kind of obstacles: 150 mm of straight pipe are suggested before and after the sensor.

Consider pressure drop correlated to in-line flow sensors, especially in case you use them in a pipeline with a different diameter than 6.35 mm: a large pressure drop across in line sensor can prematurely wear and/or damage bearings and/or sealings.

2.9.2.3 Variable area flowmeter

The variable area flowmeter does not require special installation recommendations.

The only fundamental constraint for a correct flow measurement is that this instrument must be mounted vertically and without any stress.

Obviously, to enable removal of the flowmeter when the pipeline is full, provide a shut-off valve before and after the flowmeter.

If the flowmeter is to be removed during operation it is suggested to install a bypass, as shown in picture.

To get a correct installation of the flow meter it is recommended to follow the following points associated with the corresponding photos:

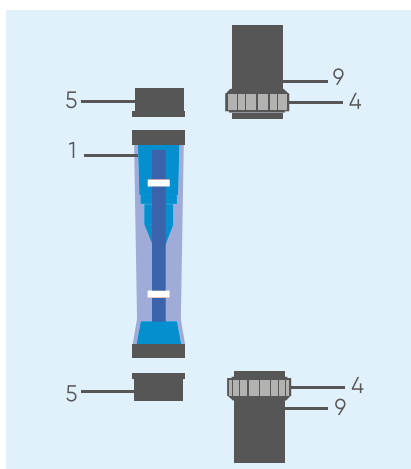
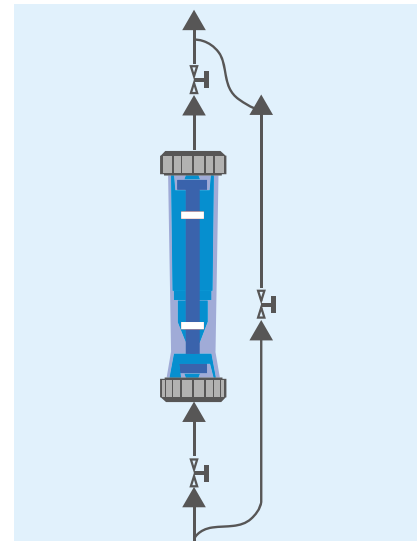

- Unscrew the union nuts 4.
- Push the union nuts 4 onto the pipes 9.

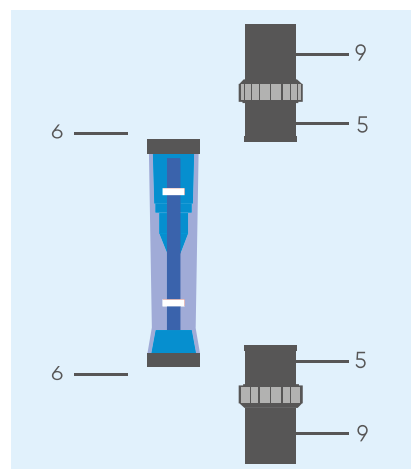

- Solvent cement, weld or screw the inserts 5 onto the pipes 9.
- Insert the O-rings 6 into the metering tube.

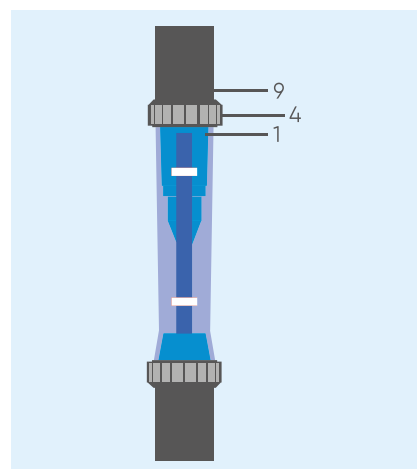

- Place the metering tube 1 between the pipes 9 and screw it in tight with the union nuts 4.
- Flowmeter is installed, check the tightness.

To conclude, it is necessary to underline the following points that must be observed during the start up phase:

- Make sure that the actual operating pressure and temperature do not exceed the limits specified on the nameplate.
- Avoid float impact: it is therefore recommendable to start during start-up against a closed valve and adjust the operating pressure by slowly opening the valve. In particular, the use of solenoid valves is not recommended in this connection.
- When measuring liquids, make a careful release of the pipeline to prevent pressure peaks by gas bubbles.
- In the case of the measurement of gases, the operating pressure must be increased slowly to avoid pressure shock.
- With the commissioning of new plants can be enhanced to fix residues in the body levitation: therefore Aliaxis recommend in such a case the cleaning of the devices after a relatively short time.
- When using the device in the lowest range, the unit must be taken for a short time at a high flow rate in operation to allow a levelling off of the float.



WARNING: What to pay attention during installation of variable area flowmeter

- Float may fall out or get damaged: carefully unscrew the union nuts.
- Metering tube and float should be clean and free from foreign matter.
- Dust protection caps and transportation protection must have been removed.
- Pipelines should be aligned and installed without any mechanical stress.
- The flow should be from bottom to top.
- The plant must have been rinsed and be free from foreign matter and harmful substances.
- Pipeline vibrations should be kept away from the flowmeter by appropriate installation measures.
- The media pressure must be enough to overcome the pressure loss at the float.



WARNING: Special features for the measurement of gas flows in variable area flowmeter

- Valves must be mounted behind the unit when $p > 1$ bar and usually before the device when $p = 1$ bar.
- Install a throttle directly behind the meter to prevent compression vibrations during the measurement.
- To avoid incorrect measurements, the arrangement should be such that the operating pressure in the meter corresponds to the reference pressure calibration.

2.10 Selection of pH and ORP sensor

2.10.1 pH and ORP sensor design

2.10.1.1 pH measurement

A pH sensor is an instrument used to measure the degree of acidity or alkalinity of a solution, also known as pH, measured on a scale from 0 to 14.

pH is defined as the negative logarithm of the activity of hydrogen ions, as shown in the following formula:

$$pH = \log\left(\frac{1}{[H^+]}\right)$$

where:

[H⁺] is hydrogen ion concentration (mol/l)

The pH value is an expression of the ratio of [H⁺] to [OH⁻], the hydroxide ion concentration.

Therefore, if the [H⁺] is greater than [OH⁻], the solution is acidic. Conversely, if the [OH⁻] is greater than the [H⁺], the solution is basic.

At 7 pH, the ratio of [H⁺] to [OH⁻] is equal and, therefore, the solution is neutral.

The measurement of PH by potentiometric means involves the use of an electrode capable of measuring the hydrogen ion concentration.

Therefore, a pH system consists of three parts, as shown in the following picture:

- a pH measuring electrode, featured by a hydrogen ion sensitive glass bulb;
- a reference electrode, no sensitive to activity variation of hydrogen ion;
- an high impedance input meter.

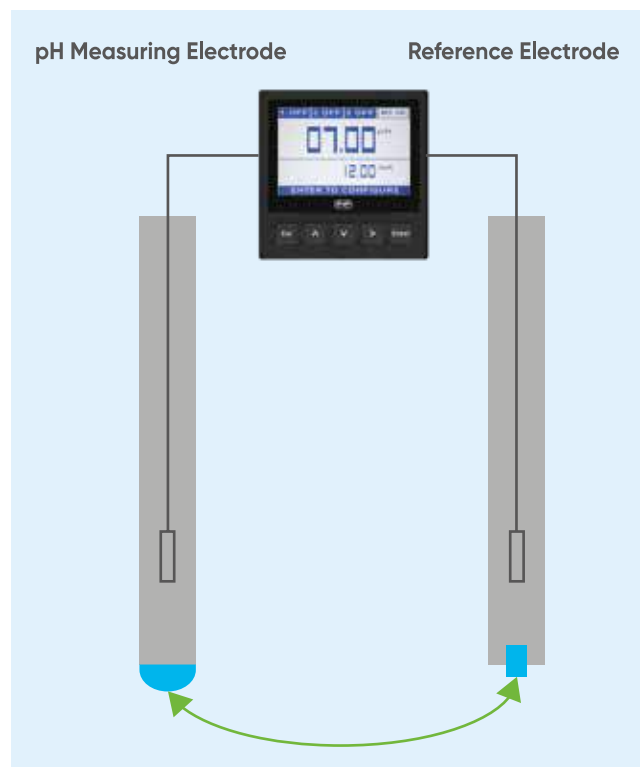

The description of electrode behaviour can be described by the Nernst equation in 1889, expressed as:

$$E_p = E_0 - \left(\frac{2.3 * R * T}{n * F}\right) * \log a$$

where:

E_p = total potential between two electrodes (mV)

E_0 = standard potential of the ion

R = universal gas constant (J/(mol*K))

T = temperature (K)

n = charge of the ion

F = Faraday constant (C/mol)

a = activity of the ion

The entire term $(2.3 * R * T) / (n * F)$ is called Nernst factor, or slope factor: this term provides the amount of change in total potential for every ten-fold change in ion concentration.

For hydrogen ion activity, where $n = 1$, the Nernst factor is 59.16 mV for every ten-fold change in activity at 25°C.

This means that for every pH unit change, the total potential will change 59.16 mV at 25°C.

As can be seen in the next picture, the alkaline solutions give a negative signal (-mV), acid solutions a positive signal (+mV) and pH 7 corresponds to 0 mV.

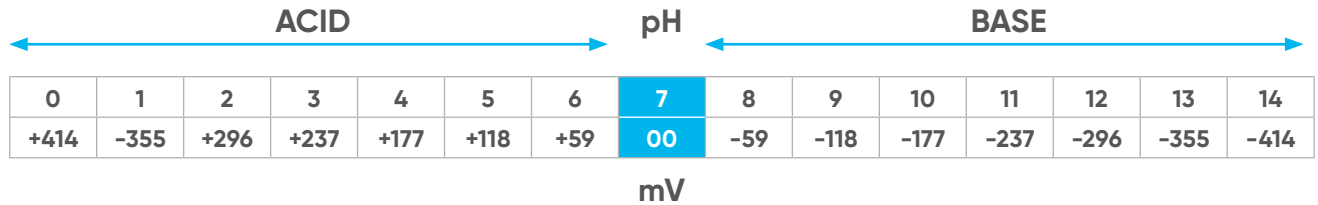

The measurement and reference electrodes can be in two shapes: two physically separate electrodes, as shown in the previous figure, or joined together in a single body known as a combined electrode.

Combined pH electrode means an electrode composed by two half cell: measuring electrode and reference electrode, with the pH sensitive part corresponding to a thin glass membrane sensitive to $[H^+]$ ions.

Typically it consists of an external tube containing a silver wire, silver chloride and an electrolyte, which act as a reference electrode and an inner tube which acts as a measuring electrode, which contains a wire silver, silver chloride and a buffer solution.

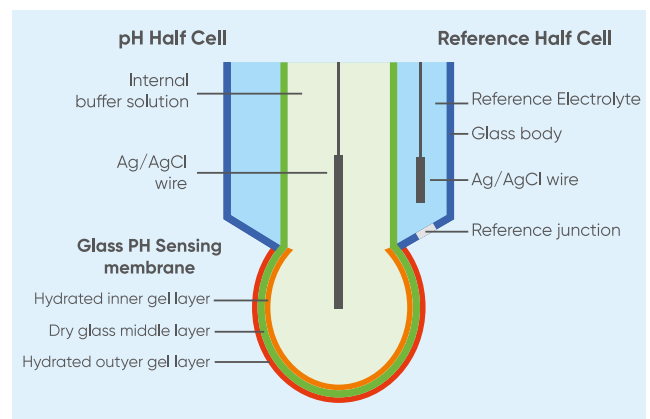

The inner tube is in contact with the solution of the sample to be measured through a thin glass membrane placed at its end, while the outer tube is in contact with the solution of the sample to be measured through a porous diaphragm which acts as a salt bridge.

On the outer and inner surface of the thin glass membrane, the exchange between the Li ions of the glass and the $[H^+]$ ions of the solutions with which these surfaces are in contact takes place.

The inner face is in contact with the buffered solution at a known pH and physically isolated from the external environment, the outer face is in contact with the solution under test:

- if the solution is acidic, there will be an accumulation of $[H^+]$ ions on the surface layer of the membrane;
- if the solution is basic there will be a depletion of $[H^+]$ ions on the surface layer of the membrane.

The electric potential recorded by the electrode is due to this imbalance between the $[H^+]$ ions present on the inner and outer surface layers of the membrane.

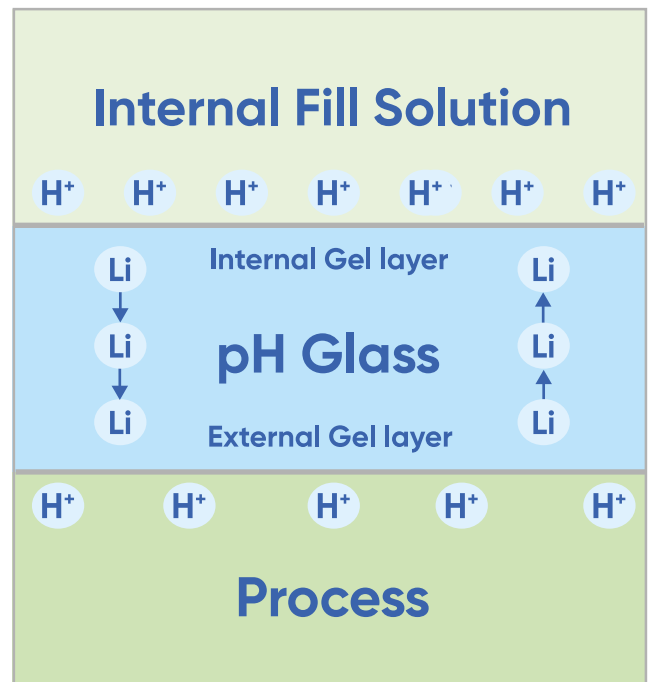

As regards the reference electrode instead, it can be made in two ways:

1) single junction: for general purpose applications, suitable when chlorides anion and silver cation are not cause of unwanted reaction.

2) double junction: advised when it's important to have an extra barrier to avoid a reference solution contamination due to presence of sulphides, proteins, heavy metals. In fact these electrodes have an additional salt bridge to prevent reactions between the electrode solution and sample which would otherwise cause damage to the electrode junction.

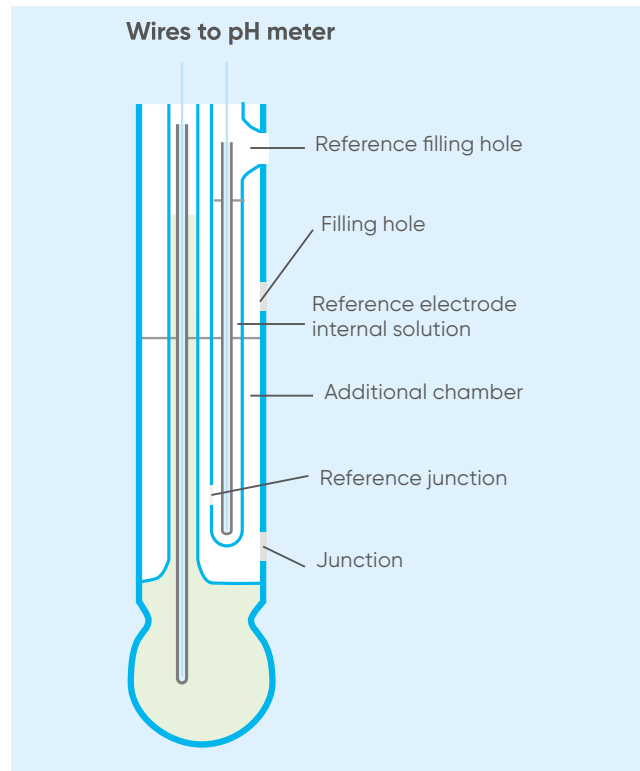
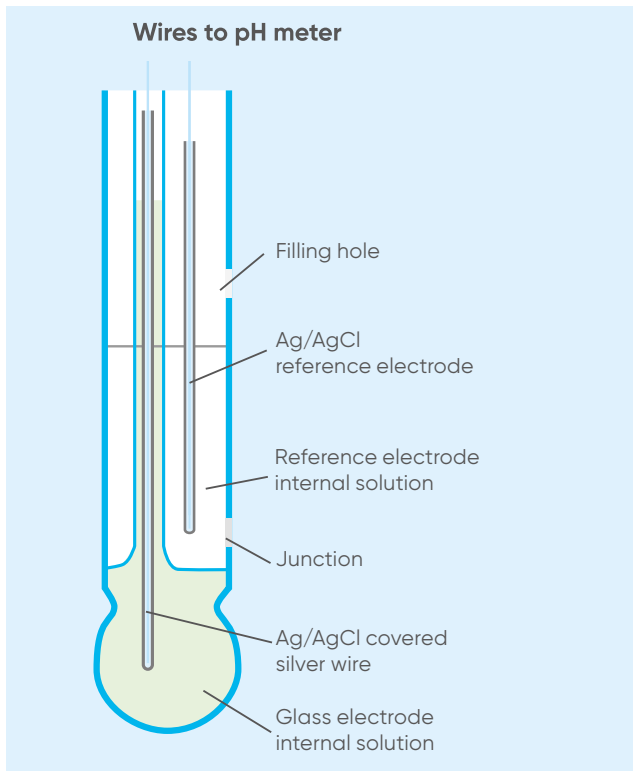

Temperature effects on pH

Temperature affects the pH measurement in two ways:

- As solution temperature changes, the pH value also modifies, due to changes in dissociation constants of the ions in the solution being measured. The available instrumentation cannot account for this because the dissociation constants vary from solution to solution.
- Since the glass measuring electrode is an ionic conductor, the resistance of the glass will change as the solution temperature modifies. This is because the millivolt output of the glass pH electrode will change with temperature in accordance with the Nernst equation.

In particular, as temperature rises, millivolt output increases, for example:

- at 25°C the slope of the pH electrode is 59.16 mV/pH unit;
- at 0°C the slope of the pH electrode is 54.2 mV/pH unit;
- at 50°C the slope of the pH electrode is 64.1 mV/pH unit;

This change can be compensated in the pH meter, in fact this linear function for temperature vs pH change can be expressed as:

0.003 pH error every pH unit and every °C.

To conclude, it is necessary to remember that the increase of temperature affects pH electrode's life.

A typical pH electrode's life is about 12-18 months, but it is reduced by 50% every 25°C increase in operating temperature, as shown in the next diagram.

To conclude, it is necessary to remember that the increase of temperature affects pH electrode's life.

A typical pH electrode's life is about 12-18 months, but it is reduced by 50% every 25°C increase in operating temperature, as shown in the next diagram.

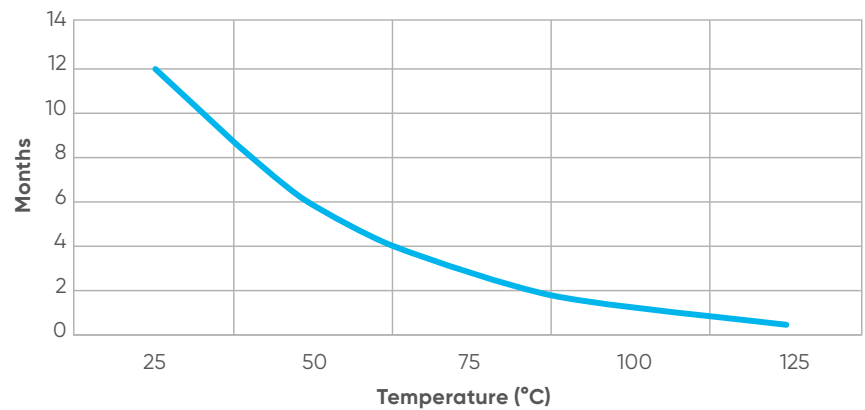

The suggestions to minimize this problem are to practice a cooling or to do intermittent measurements instead of continuous ones: in this way the electrode will be less affected by the temperature change.

PRACTICAL EXAMPLE

For example, if a pH system is standardized in pH 7 buffer at 25 °C, at 75 °C an uncompensated pH system would read 4.45 pH because:

$$0.003 * (7\text{pH} - 4\text{pH}) * (75^\circ\text{C} - 25^\circ\text{C}) = 0.45$$

2.10.1.2 ORP measurement

ORP (Oxidation-Reduction Potential) is the measure, in millivolts, of the tendency of a chemical substance or solution to oxidize or reduce another chemical substance.

In particular, oxidation is the loss of electrons by an atom, molecule or ion, while reduction is the net gain of electrons.

An ORP sensor consists of an ORP electrode and a reference electrode, as pH measurement.

The principle behind this kind of measurement is the use of an inert metal electrode (platinum, or gold), which, due to its low resistance, will give up electrons to an oxidant or accept electrons from a reductant.

The ORP electrode will continue to accept or give up electrons until it develops a potential, due to the build up charge, which is equal to the ORP of the solution.

For the reference electrode the same considerations made for the pH reference electrode apply.

This picture shows an ORP system.

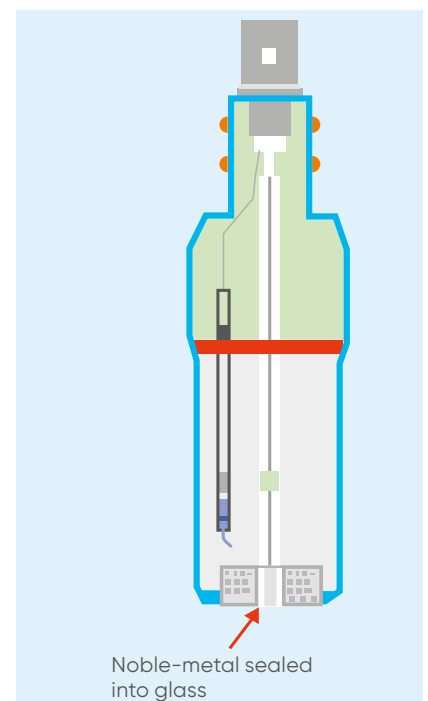

2.10.1.3 pH/ORP electrodes

Depending on the applications and the main features, there are four different groups of pH and ORP sensors:

Epoxy body bulb electrode

This line of electrodes has been designed to provide a cost effective solution for in-line or underwater monitoring with a wide application range.

Single and double junction models are available and can be used up to 60 °C. Moreover, for automatic temperature compensation, a pH option with temperature sensor integrated is available.

These epoxy body electrodes are suitable for the following applications, thanks to the high chemical resistance of the material:

- Water treatment.
- Neutralization systems.
- Water quality monitoring.
- Swimming pools and spas.
- Aquaculture.
- Agriculture and fertilizing systems.
- Process control.



Glass body bulb electrode

Electrodes with glass body are high performance sensors and have been designed for a wide range of applications:

- Water treatment.
- Neutralization systems.
- Water quality monitoring.
- Process control.
- Agriculture and fertilizing systems.
- Plating plant and tannery.
- Cooling towers and scrubbers.

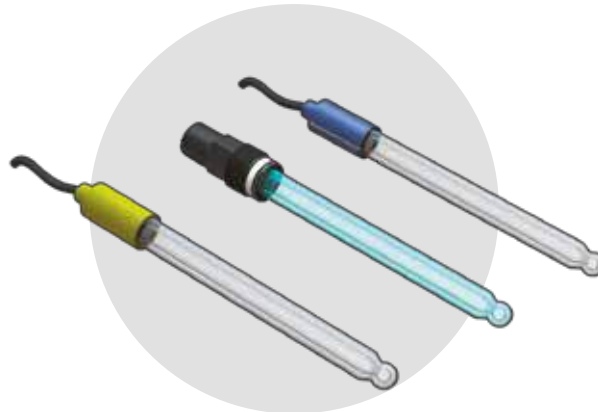

The ceramic joint guarantees high performance in terms of pressure and temperature (up to 130 ° C). It is not suggested for fast flow.

Different types of ceramic joints are available based on application requirements: annular for faster response time, with three diaphragm for higher pressure. In addition, the double junction prevent contamination of the reference solution ensuring a long service life.

CPVC body flat surface electrode

This is the rugged version of the traditional flat electrodes with an improved self cleaning effect: thanks to the final flat surface, the dirty liquid passes by without stopping near the electrode surface so it does not contaminate it. It is suggested also for fast flow.

Into the electrode's body there is a sealed, gel-filled double junction: this design provides an extra barrier against reference side contamination and allows the electrodes to be used in severe applications prolonging electrode life.

It is used in several applications such as:

- Water and Wastewater treatment.
- Prechlorination and dechlorination.
- Neutralization systems.
- Water quality monitoring.
- Ozone treatment.
- Cooling towers.
- Boiler systems.
- Bleach production.
- Pulp bleaching.
- Aquaculture.
- Textile Dye Process.

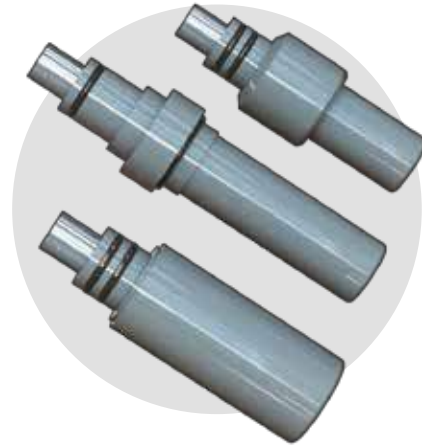

Ryton body flat surface electrode

This electrode is characterized by a solid Ryton body joined to a flat surface self-cleaning, so it can be used with fast flow and dirty liquids; it has a temperature sensor combined.

A big junction size improves performance in the presence of suspended solids.

It is suggested for these applications:

- Processing and Manufacturing industry.
- Chemical processing.
- Water treatment processes.
- Cooling processes.
- Heating processes.



2.10.2 pH and ORP sensor installation

There are three ways in which a pH/ORP electrode can be installed, it is possible to differentiate sensors in:

- in line sensors;
- submersible sensors;
- hot-tap sensors.

2.10.2.1 Installation guidelines

In line installation

In line installation is available for all pH/ORP sensor families and it is suggested for application in a pipe range from DN15 up to DN100.

In particular, for installation in small pipes it is suggested to pay attention that pH glass is not in contact with pipe surface.

pH/ORP electrodes can be installed at 30° maximum from vertical position, being sure that sensor is completely in contact with the measured solution.

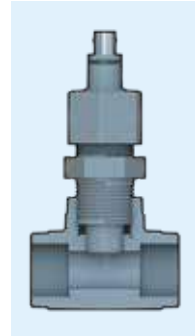

Submersible installation

Submersible installation is available for epoxy body bulb electrodes and for C-PVC body flat surface electrode.

Electrode should be installed near tank outlet away from addition areas in order to measure a representative solution.

Sensor should be below the drain level to prevent the electrode from drying out.

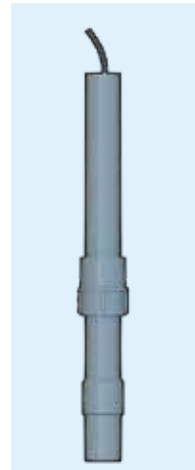

Hot tap installation

Hot tap installation is available only for a special version of CPVC body flat surface electrode (PH655CD, ORP655CD).

Hot tap installation can be useful in case application needs a positioning of electrode different than standard 30° from vertical position as well for in line application where it can't be depressurized during maintenance.

Hot tap installation can also solve problem to perform a in-line installation on pipes bigger than DN100.

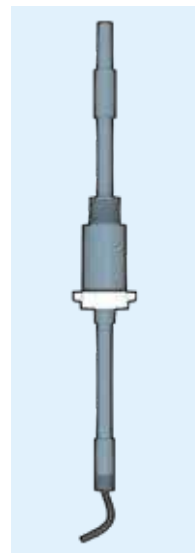

2.10.2.2 Operating guidelines

Storage

When pH readings are made infrequently, for example, several days or weeks apart, the electrode can be stored simply by replacing it in its soaker bottle or protection cap.

If the storage solution in the soaker bottle is missed or dried, it is suggested to use 3M KCl or a pH 4 buffer.

Care and Cleaning

Coating of an electrode's measuring surface can lead to wrong readings including shortened span and slow response times.

Obviously, the type of coating determines the type of cleaning technique:

- soft coatings can be removed by vigorous stirring, by use of a spray bottle or, very carefully, by gently wiping with a soft and clean non-abrasive paper or cloth.
- Do not use any brush or abrasive cleaner on pH glass.
- hard coatings should be chemically removed: the chemical used to remove the coating should be the least harsh chemical that dissolves the coating in 1 or 2 minutes and does not attack the electrode's materials of construction.

Abrading or sanding a pH electrode's surface should never be done.

In particular, for ORP sensor, the electrode may be gently abraded by use of 600 grade wet silicon carbide paper, jeweller's rouge or very fine steel wool, but try to clean chemically before abrading with 600 grade paper.

Reconditioning

When reconditioning is required due to electrode aging, it is suggested to try the following chemical treatments presented in the order of the severity of attack on the pH glass, but they may not improve (and in some cases actually further deteriorate) electrode performance.

- Dip the electrode tip in 0.1 M HCl for 15 seconds, rinse in tap water and then immerse tip in 0.1 M NaOH for 15 seconds and rinse in tap water.

Repeat this sequence three times and then recheck the electrode's performance.

If performance has not been restored, try the following step.

- Dip the tip in a 20% solution of ammonium difluoride for 2 to 3 minutes, rinse in tap water and recheck performance.

If performance has not been restored try the following step.

- Immerse electrode tip in 5% HF for 10-15 seconds, rinse well in tap water, quickly rinse in 5 M HCl, rinse well in tap water and recheck performance.

If performance has not been restored another pH electrode should be used.

For ORP sensor it is suggested to clean metal surfaces with a mildly abrasive medium, as toothpaste or very fine scouring powder.



WARNING

Use proper precautions when handling the previous hazardous chemicals. Ammonium difluoride and hydrofluoric acid are extremely hazardous and should only be used by qualified personnel.

Calibration

Calibration is fundamental to achieve a good accuracy and a reliable measurement.

The frequency of calibration is function of the electrode, the pH meter and the solutions the electrode is exposed to. Moreover this frequency is correlated to temperature of application and to how much critical the measurement is. Automatic calibration with standard value of buffer (pH 7, pH 4, pH 10) can be used for general purpose.

It is necessary to consider that pH 10 buffer is less stable than pH 4 buffer as CO₂ can be dissolved in, therefore in case the same buffer bottle is used for several calibration, it's better to prefer pH 4.

Remember to clean electrode in some water before to dip it in each buffer in order to avoid a buffer contamination. In case a higher precision at a fixed value is needed, a manual calibration could be used to perform a calibration using buffers around expected value.

2.11 Selection of conductivity sensor

2.11.1 Conductivity sensor design

2.11.1.1 Conductivity measurement

Conductivity is the ability of an electrolyte solution to pass an electric current. This current is carried by cations and anions. The SI unit of conductivity is Siemens per meter (S/m) and refers to 25 °C. How well a solution conducts electricity depends on several factors, such as concentration, mobility and valence of ions, temperature.

Conductivity is measured by applying an impressed voltage (U) to two electrodes immersed in a solution at a certain distance (d). During this process, the cations migrate to the negative electrode, the anions to the positive electrode and the solution acts as an electrical conductor. In this way the generated current (I) and conductivity or resistivity can be measured.

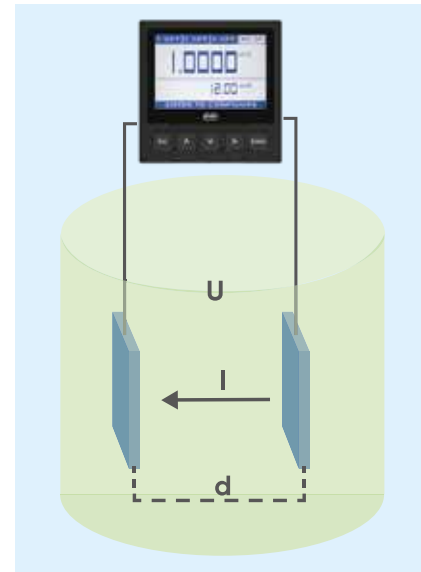

In addition, to calculate conductivity it is fundamental to know what cell constant is. It is defined as the ratio of the distance (d) between the electrodes to the area (S) of the electrodes as described by the following equation:

$$K = \frac{d}{S}$$

where:

K = cell constant (m⁻¹)

d = distance between electrodes (m)

S = surface of electrodes (m²)

Therefore, conductivity can be expressed as:

$$k = \frac{d}{S} * \frac{1}{R}$$

where:

k = conductivity (S/m)

d = distance between electrodes (m)

S = surface of electrodes (m²)

R = resistance (ohm = 1/S)

The cell constant is fundamental for the conductivity calculation, as it directly affects the sensitivity and accuracy of the measurement.

In particular, lower cell constants are required to provide a good signal to the measuring instrument for low conductivity (so high resistivity) samples. Vice versa higher cell constants are required to measure high conductivity (so low resistivity) samples. The measuring instrument must know the exact cell constant of the connected sensor and normalize the reading accordingly.

To give an example, the following table shows some values of constant cell according to operating range of sensor and applications.

Cell constant (K)	0.01	0.1	1	10
Operating range	0.055 µS to 200 µS	0.1 µS to 2000 µS Optimum: 0.5-200 µS	1 µS to 20000 µS Optimum: 5-10000 µS	10 µS to 200000 µS Optimum: 0.5-200 mS
Applications	Ultra-pure water	Deionized water distilled water	Distilled water, tap water, cooling tower	Waste water, sea water

Temperature effects on conductivity

Temperature has a significant effect on conductivity.

In general, an increase in temperature of solution causes a decrease in its viscosity and an increase in the mobility and number of the ions in solution due to dissociation of molecules.

As the conductivity of a solution is dependent on these factors, an increase in the temperature of solution will lead to an increase in its conductivity.

For example, in low ionic concentrations, such as very pure water, the ionization of the water furnishes several conducting ions: this process is temperature dependent, and as a result, the conductivity has a dependence on temperature.

This dependence is usually expressed as a relative change per degree Celsius at a particular temperature, called reference temperature, usually corresponding to 25 °C, 20 °C or 18 °C.

This rate at which a solution's conductivity increases is called temperature coefficient of variation, or temperature compensation coefficient.

The coefficient of variation is different for each solvent or mixture, some values according to different liquids can be found in the following table. In making conductivity readings at high and low temperatures, the data is usually normalized to 25°C.

Solution	Temperature coefficient of variation %/°C at 25°C
Ultrapure water	5.5
NaOH 5%	2.01
NaOH 30%	4.50
HCl 5%	1.58
HCl 30%	1.52
KCl 5%	2.01
KCl 20%	1.68
Fresh water	~ 2.0

From these data, it is clear that a small difference in temperature makes a large difference in conductivity, and the effect is very inconvenient when a high degree of accuracy is required.

2.11.2.1 Conductivity electrodes

Depending on the applications and the main features, there are three different groups of conductivity sensors:

Graphite or Platinum sensor

These conductivity sensors are equipped with graphite or platinum electrodes for high resolution and the body, in epoxy resin, guarantees high resistance and reliability.

They are able to ensure an accurate and high resolution measurement thanks also to the included temperature sensor, combined with the ATC function (automatic temperature compensation) indicator.

In addition, the electrodes are effectively protected, so it is unlikely for the constant cell to be damaged by presence of solids: there are three cell constants available (0.1, 1, 10), one depending on the required exercise interval.

They can be used for laboratory and industrial applications on clean fluids, such as:

- Chemical concentrations.
- Food industry.
- Steam generation.
- Metal finishing and mining.
- Textile industry.
- Pulp and paper.
- Water treatment.
- Reverse osmosis.
- De-ionization.
- Distillation.
- Aquaculture.
- Agriculture and fertilizing systems.



Stainless steel conductivity sensor

Two different types of series are part of the stainless steel sensors.

In particular, the C100 series is designed for agriculture and for light industrial applications and dirty fluids, where the conditions of the samples allow the use of steel. It is used for example in applications in which clogging phenomena can occur:

- Water treatment.
- Food industry.
- Agriculture system.
- Power plant boiler.

This type of sensor is characterized by a particularly convenient ratio between cost and performance.

The combination of the temperature sensor with the ATC function (compensation automatic temperature) of the indicator allows to obtain an accurate measurement. Furthermore, the wide choice of cell constants guarantees the availability of the most suitable product for countless specific applications.

The C300 series, on the other hand, has been designed for ultrapure water monitoring, with a certified cell constant 0,01 and for wastewater with a cell constant 10.



Inductive conductivity transmitter

This inductive conductivity transmitter is made by a 4-20mA output device integrated onto an inductive conductivity sensor. This type of measurement technology allows a broad range of applications especially to measure high values of conductivity (from 10 mS to 1000 mS) in aggressive fluids, in fact C-PVC is the only wetted material).

As no electrodes are directly in contact with liquid, a reliable and stable measurement is guaranteed for a long operating time. A proper automatic temperature compensation (ATC) is granted into instrument body.

It is mainly used in these applications:

- Water and wastewater treatment.
- Cooling tower.
- Scrubber system.
- Metal finishing and corrosion fluids.

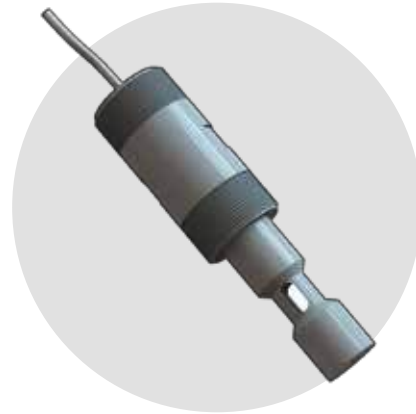

2.11.2 Conductivity sensor installation

There are two ways in which a conductivity sensor can be installed, so it is possible to have:

- in line sensors;
- submersible sensors.

2.11.2.1 Installation guidelines

In line installation

In line installation is available for all conductivity sensors.

In particular, it's possible to perform two different types of in-line installation:

- vertically on a straight pipeline using a proper T fitting: this installation should be carried out with an upside down mounting (or at least at 45°) because this condition help to prevent air entrapment.
- through the side of a T fitting: this installation type is preferred since this configuration reduces the probability of entrapped air bubbles and provides the best continuous sampling of the fluid.

It is always necessary to pay attention that the electrodes of the sensor are completely dipped into a representative solution, so not in a dead volume.

Conductivity sensors can work properly in any direction.

An example of in line installation is shown in the next picture.

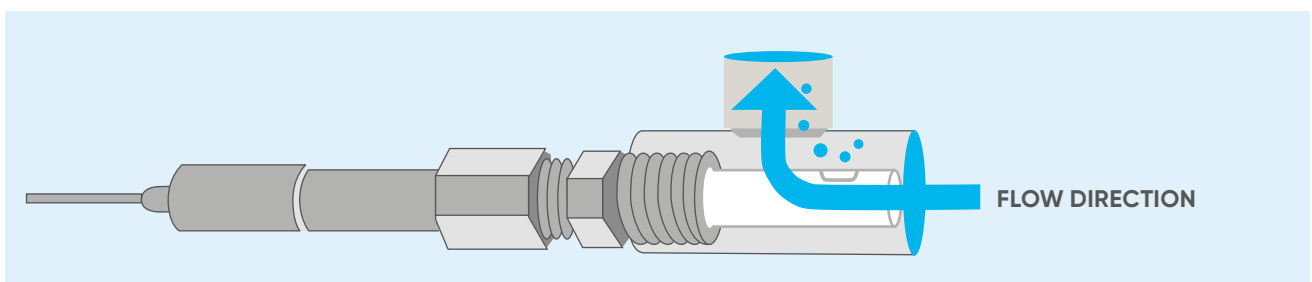

Submersible installation

Submersible installation is available for graphite or platinum conductivity sensor family.

Sensor should be installed near tank outlet away from addition areas in order to measure a representative solution.

The following picture shows an example of submersible installation.

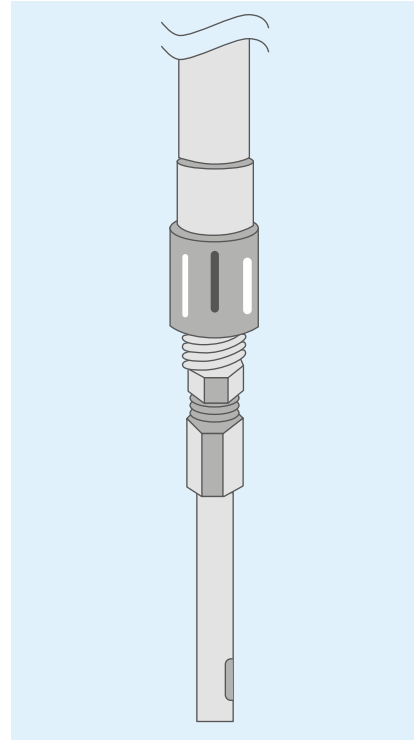

2.11.2.2 Operating guidelines

Care and cleaning

All conductivity sensors can be cleaned with a gentle detergent, in addition graphite or platinum sensor families can be cleaned using a 5% HCl solution.

Do not sand or abrade the electrodes surface as abrasion changes the surface area and will cause erroneous readings.

Anyway every solution compatible with electrodes material and sensor body material can be used.

Calibration

Calibration is fundamental to achieve a good accuracy and a reliable measurement.

The frequency of calibration is a function of the sensor, the solutions that has to be measured and it is correlated to how much critical the measurement is.

Pay attention that air bubbles are not present during calibration since such condition could cause a erroneous readings.

As temperature affects strongly conductivity measurement, it is necessary to pay attention to:

- reference temperature (it should be the same for monitor and for calibration solution);
- temperature compensation: in particular, if this is activated the conductivity value of calibration solution at reference temperature should be used; if it is not activated it is suggested to use the conductivity value of calibration solution at calibration solution temperature.
- temperature compensation factor: check if it's proper for calibration and for measured solution.





3. Installation guidelines 194

3.1 Jointing methods 194

3.1.1 Solvent welding	195
3.1.1.1 Solvent welding of piping system in UPVC	196
3.1.1.2 Solvent welding of piping system in CPVC	200
3.1.1.3 Solvent welding of piping system in ABS	204
3.1.2 Butt welding	210
3.1.3 Socket welding	217
3.1.4 Electrofusion	224
3.1.5 Hot gas welding	228
3.1.6 Flanged joints	232
3.1.7 Threaded joints	239
3.1.8 Straub mechanical joints	243

3.2 Pipeline mounting and recommendations 253

3.2.1 Thermal expansion and contraction	253
3.2.1.1 Mechanical expansion joints	252
3.2.1.2 Offset	259
3.2.1.3 Expansion loops and direction changes	259
3.2.2 Heat tracing	261
3.2.3 Pipelines anchoring	264
3.2.3.1 Piping support and pipe restraint	265
3.2.3.2 Tables and graphs	267
3.2.4 Underground installation (buried system)	279

3.3 Pipeline testing on-site 284

3.4 Storage, transportation and handling 288

3. Installation guidelines

3.1 Jointing methods

One of the reasons why there are more and more civil and industrial sectors that turn to thermoplastic resins to solve design and construction problems in pipelines, can be identified in the great ease of making joints between thermoplastic pipes and fittings using different operating techniques.

This versatility, combined with the other physicochemical characteristics mentioned above, such as good resistance to chemical agents and inertia to electrochemical corrosion, led to a reduction in the installation and maintenance costs of thermoplastic pipes, favouring its use in medium and long-term applications also with respect to traditional construction materials.

Depending on the type of desired coupling, on the physical and mechanical characteristics of the construction material and on the conditions of use and operation, the longitudinal connection of thermoplastic resin pipes and fittings can be achieved by resorting to multiple joint systems which have often very different investments and costs.

Joining systems for connecting thermoplastic pipes are classified into two large groups, the permanent longitudinal joints and the removable longitudinal joints.

In this chapter we want to offer adequate support to all installers who have to deal with the installation of thermoplastic pipes and fittings for the first time.

For this purpose, the data and information considered necessary and useful to perform a correct installation of the thermoplastic resin components according to the main techniques currently adopted in the construction of pipes for conveying pressurized fluids have been summarized.

Permanent joints

Permanent junction systems are all those which, by exploiting an irreversible physical-chemical process, make unremovable longitudinal connections.

Considering the permanent nature of the connection, the use of these systems is widely used where high mechanical strength of the joint and extreme safety in conveying dangerous or toxic fluids or substances that can be contaminated by external agents are required.

The following permanent type joint systems are widely used in the laying of thermoplastic pipes and are described in next chapters:

- solvent welding;
- butt welding;
- infrared welding;
- socket welding;
- hot gas welding;
- electrofusion.

To evaluate the knowledge and practical skills of a welder who is required to perform welding in the construction of new plastic products or to carry out any repairs, it is necessary to refer to EN 13067 standard.

In addition, at the end of each chapter concerning every permanent joint, the most common defects that can occur are described: for more details it is advisable to consult EN 14728 standard.

Removable joints

Removable joint systems are those which, using particular mechanical elements, allow the removal of the connection without affecting the integrity of the pipeline.

They are suitable for those applications where periodic maintenance and inspection of the pipes are necessary.

In particular, the following removable junction systems are described in next chapters:

- junction with flanged elements;
- junction with threaded elements;
- mechanical jointing with Straub coupling.

3.1.1 Solvent Welding

The chemical welding with solvents the most diffused system of longitudinal junction for the coupling of pipes, fittings and valves manufactured in UPVC, CPVC and ABS.

The terms "glue" and "solvent cement" are often used interchangeably with reference to thermoplastic piping installation: on a basic level, both accomplish the immediate goal of joining pipes and fittings, but the substances are actually very different.

Glue functions with adhesion and cohesion. When two pieces of pipe are glued together, adhesive forces are those that connect the glue to each piece of pipe and a cohesive force holds the glue to itself.

On the other hand, solvent welding works in a completely different way: it is carried out using solvent cements obtained by dissolving CPVC, UPVC and ABS polymer in a mixture. This solvent liquefies the walls of the pipe and fitting, allowing the constituent material to chemically combine and be subsequently welded.

The following picture shows the difference between glue and solvent welding.

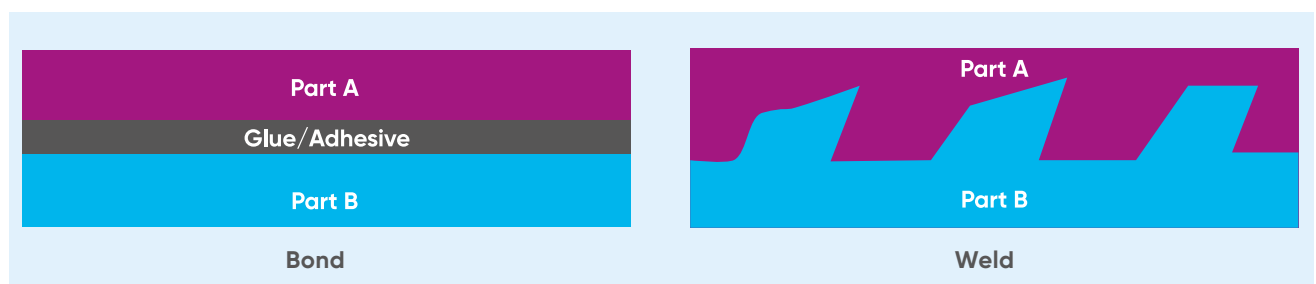

Therefore, this allows to obtain permanent longitudinal connections with mechanical and chemical features similar to the corresponding ones of the used pipes and fittings.

The mixtures must be selected in function of the type of thermoplastic resin to be welded, as the nature of the solvent changes according to it.

It must be remarked also, that all the chemical solvents destined to the longitudinal joint of thermoplastic pipelines must be used for the connection of homogeneous pipes and line accessories: it must be absolutely avoided the use of the same solvent for the welding of elements produced in different thermoplastic resin.

3.1.1.1 Solvent welding of piping system in UPVC

In the installation of pipelines in rigid UPVC the solvent welding is to be considered the more common jointing system, as associates to a wide connection possibility with fittings and accessories in UPVC a limited commitment of resources during the mounting phase.

The use of that jointing technique requests the utilise of pipes and fittings with socket ends: the socket welding with solvent allows to obtain joints with high welding coefficient which maintains unchanged the requirement of resistance to the internal pressure of the connected pipes and fittings.

Unless otherwise specified, the solvent cement used on the surfaces to join must also be usable with the following tolerances:

- maximum interference 0.2 mm;
- maximum clearance 0.6 mm.

The following table shows the value of hydraulic test pressure which must be reached by the glued joints according to the standard ISO 15493 and a safety factor of 2.5.

Test temperature (°C)	Min. test duration (h)	Test pressure (kg/cm ²)
20	1000	0.6 x PN
60	1000	1.7 x PN

As any possibility to join directly pipes with accessories of other compounds is not allowed, the solvent welding is frequently coupled to removable junctions, such as flanges or threads and so on, permitting anyway the use of rigid UPVC pipelines also in particularly sophisticated lines containing various instruments and accessories.

In order to obtain a perfect connection between pipe and fitting it is necessary choose and use the most suitable glue designed and produced for the longitudinal joint of pipes in rigid UPVC, according to the dimensional features of the connecting items and of the service condition at which shall be subjected the just realised junction.

Welding instructions for the longitudinal connection of pipes and fittings in UPVC

Before starting any solvent welding operations, the efficiency and condition of the equipment used and the pieces to be assembled must be verified, in particular the uniformity, fluidity and expiry date of the solvent cement.

The main steps that solvent welding requires are the following:



- 1)** Cut the pipe perpendicular to its axis to obtain a clean square section, preferably using a wheeled pipe cutter designed specifically for thermoplastic pipes.



- 2)** Chamfer the outer edges of the pipe in order to ensure that it enters the socket of the fitting at an angle of 15°.

The chamfering operation must be carried out at all costs, otherwise the lack of chamfer can lead to the solvent being scraped off the surface of the fitting, thus compromising the effectiveness of the joint. The chamfering must be carried out using the appropriate chamfering tool.

To have more details about the chamfer length according to the length and the diameter of the pipe, refer to the following table and to the corresponding picture.

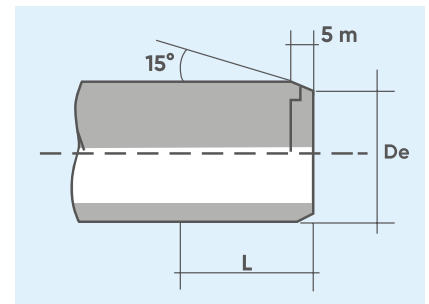

External diameter De (mm)	Cementing length L (mm)	Chamfer Sm (mm)
16	14	-
20	16	1.5
25	18.5	3
32	22	3
40	26	3
50	31	3
63	37.5	5
75	43.5	5
90	51	5
110	61	5
125	68.5	5
140	76	5
160	86	5
180	96	5-6
200	106	5-6
225	118.5	5-6
250	131	5-6
280	146	5-6
315	163.5	5-6



3) Measure the depth of the socket of the fitting to the internal shoulder.



4) Mark the corresponding distance on the end of the pipe.

NOTE: do not carry out any mark by engraving.



5) By using a clean paper towel or applicator soaked in Cleaner-Primer, remove any traces of dirt or grease from the outer surface of the pipe for the entire cementing length.

Repeat the same operation on the internal surface of the socket of the fitting in order to leave the surfaces softened.

Leave the surfaces to dry for a few minutes before applying the solvent cement.

Remember that, in addition to cleaning the joint surfaces, the Cleaner-Primer also performs the important role of softening and preparing the surface to receive the solvent, an operation that enables a perfect joint to be obtained.

NOTE: avoid handling the clean surfaces.



6) Apply the solvent cement in a uniform manner longitudinally over both parts to be assembled, so outer surface of the pipe and internal surface of the fitting.

The application of the glue layer on pipes and fittings must be extended to the full length of the fitting surfaces, and expressly:

- to the entire pipe end length, previously marked on its external surface (picture **A**),
- to the entire socket depth of the fitting up to the internal stop (picture **B**).



To do this it is suggested to use a rough and clean brush adequately dimensioned, its dimension should not be less than half of the diameter of the pipe: for more detailed information refer to the following table.

External diameter D_e (mm)	Type of brush or applicator	Dimensions of brush or applicator (mm)
16-25	Round	8-10
32-63	Round	20-25
75-160	Rectangular/round	45-50
>160	Rectangular/cylindrical	45-50
>160-315	Rectangular/cylindrical	60-65



7) Pipe must be inserted into the fitting or valve immediately after application of the solvent, without rotation; only after reaching the insertion depth provided, it is possible to rotate up to a maximum of 1/4 turn between tube and fitting.

8) Depending on the external diameter of the pipe and possible handling difficulties, the insertion of the pipe into the fitting must be carried out:

- manually by one person for external diameters < 90 mm;
- manually by two people for external diameters for 90 mm < De < 160 mm;
- using mechanical pipe-pullers for external diameters > 160 mm.



9) Immediately after fully inserting the pipe in the fitting, apply pressure to the joined parts for a few seconds.

Then use crepe paper or a clean cloth to remove any excess solvent cement from the outer surfaces, and from internal surfaces where possible.



10) The joined parts must be left to stand in order to allow the solvent cement to set naturally without generating any unnecessary stress.

The setting time depends on the amount of stress that the joint will be placed under.

In particular, the following minimum setting times must be respected according to the ambient temperature:

- before handling the joint:
 - from 5 to 10 minutes for ambient T > 10°C,
 - from 15 to 20 minutes for ambient T < 10°C;
- for joints on pipes of any size or pressure not subject to hydraulic testing:
 - 1 hour for each atm of applied pressure;
- for joints in pipes and fittings of any diameter subject to pressure testing up to PN 16:
 - minimum 24 hours.

The solvent cement setting times indicated are valid at ambient temperature (approximately 25°C): for particular climatic conditions (humidity, temperature and so on), we recommend you contact our technical services department and/or the solvent cement manufacturer for more information.

Amount of solvent cement for UPVC material

The amount of solvent cement used on the joints depends on a number of factors (environmental conditions, pipe size, cement viscosity, operator experience, etc.) which are often difficult to quantify.

In this respect, the table reports the approximate quantities of cement normally used for joining diameter pipes and fittings in UPVC.

D (mm)	Number of joints per kg of solvent cement
16	550
20	500
25	450
32	400
40	300
50	200
63	140
75	90
90	60
110	40
125	30
140	25
160	15
180	12
200	10
225	6
250	4
280	2
315	2

3.1.1.2 Solvent welding of piping system in CPVC

Thanks to the high resin quality and to the own mechanical and chemical-physical features of the CPVC, this represents one of the most economic solution in the range of the thermoplastic materials in order to solve the problems which can be encountered in the distribution of hot and cold sanitary water and in the transport of aggressive chemicals under pressure.

The main reasons of this preference are to be attributed to the following properties:

- high resistance to particularly aggressive chemicals;
- inert to electro-chemical corrosion (optimal to convey hot sanitary water in conventional and solar panels plants);
- reduced coefficient of thermal conductivity (virtual elimination of condensation problems);
- high resistance to ageing, thanks to the chemical-physical features of the base material;
- low superficial roughness which reduces strongly the fluid friction loss and the growth of encrustation and seaweeds;
- possibility of conveying alimentary fluids;
- high thermal stability for temperatures up to 100°C;
- high combustion resistance.

As regards mechanical characteristics, the following table shows the values of hydraulic test pressure which must be reached by the glued joints in CPVC according to the standard ISO 15493 and a safety factor of 2.5.

Test temperature (°C)	Min. test duration (h)	Test pressure (kg/cm ²)
20	1000	1.7 x PN
80	1000	0.5 x PN

As for UPVC, even for CPVC any possibility to join directly pipes and accessories of other materials is not allowed, so the solvent welding is often connected to movable joints, as flanges or threads and so on.

Unless otherwise specified, the solvent cement used on the surfaces to join must also be usable with the following tolerances:

- maximum interference 0.2 mm;
- maximum clearance 0.3 mm.

Welding instructions for the longitudinal connection of pipes and fittings in CPVC

Before starting any solvent welding operations, the efficiency and condition of the equipment used and the pieces to be assembled must be verified, in particular the uniformity, fluidity and expiry date of the solvent cement.

The main steps for welding operations are the following:



- 1) Cut the pipe perpendicular to its axis to obtain a clean square section, if possible by using a wheeled pipe cutter designed specifically for thermoplastic pipes, as shown in this picture.



- 2) Chamfer the outer edges of the pipe in order to ensure that it enters the socket of the fitting at an angle of 15°. The chamfering operation must be carried out at all costs, otherwise the lack of chamfer can lead to the solvent being scraped off the surface of the fitting, thus compromising the effectiveness of the joint. The chamfering must be carried out using the appropriate chamfering tool.

To have more details about the chamfer length according to the length and the diameter of the pipe, refer to the following table and picture.

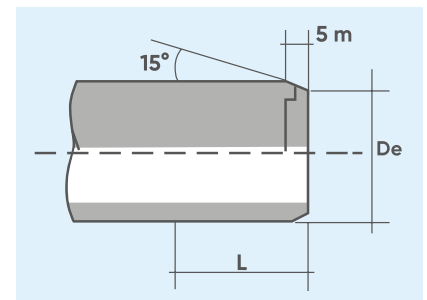

External diameter D_e (mm)	Cementing length L (mm)	Chamfer S_m (mm)
16	14	1.5
20	16	1.5
25	18.5	3
32	22	3
40	26	3
50	31	3
63	37.5	5
75	43.5	5
90	51	5
110	61	5
160	86	5
225	118.5	5-6



3) Measure the depth of the socket of the fitting to the internal shoulder.



4) Mark the corresponding distance on the end of the pipe.

NOTE: do not carry out any mark by engraving.



A

5) Using a clean paper towel or applicator soaked in Cleaner-Primer, remove any traces of dirt or grease from the outer surface of the pipe for the entire cementing length (picture **A**).

Repeat the same operation on the internal surface of the socket of the fitting, leaving the surfaces softened (picture **B**).

NOTE: avoid handling clean surfaces.

Leave the surfaces to dry for a few minutes before applying the solvent cement.

Remember that, in addition to cleaning the joint surfaces, primer performs the important role of softening and preparing the surface to receive the solvent cement, an operation that enables a perfect joint to be obtained.



B



C

5) Apply the solvent cement in a uniform manner longitudinally over both parts to be assembled, so outer surface of the pipe and internal coupling surface of the fitting, by using an applicator (picture **C**) or suitably sized coarse brush (picture **D**) according to the following table.



D

External diameter De (mm)	Type of brush or applicator	Dimensions of brush or applicator (mm)
16-25	Round	8-10
32-63	Round	20-25
75-160	Rectangular/round	45-50
>160	Rectangular/cylindrical	45-50

It is advisable to use an applicator or brush of dimensions not less than half the diameter of the pipe.

The solvent cement must be applied along the entire length of the joining surface of both the pipe and the fitting:

- for the entire depth of the socket of the fitting as far as the internal shoulder;
- for the entire joint length of the pipe previously marked on the outer surface.



6) Pipe must be inserted into the fitting or valve immediately after application of the solvent, without rotation; only after reaching the insertion depth provided, it is possible to rotate up to a maximum of 1/4 turn between tube and fitting.

7) The pipe must be inserted in the fitting as soon and as quick as possible (after no more than 20-25 seconds is recommended). Depending on the external diameter of the pipe and, as a result, possible handling difficulties, the insertion of the pipe into the fitting must be carried out:

- manually by one person for external diameters < 90 mm.
- manually by two people for external diameters from 90 to < 160 mm.
- using mechanical pipe-pullers for external diameters > 160 mm.

8) Immediately after fully inserting the pipe in the fitting, apply pressure to the joined parts for a few seconds. Then use crepe paper or a clean cloth to remove any excess solvent cement from the outer surfaces, and from internal surfaces where possible, as next picture shows.



9) Solvent cement setting: the joined parts must be left to stand in order to allow the solvent cement to set naturally without generating any unnecessary stress.

The setting time depends on the amount of stress that the joint will be placed under. In particular, the following minimum setting times must be respected according to the ambient temperature:

- before handling the joint:
 - from 5 to 10 minutes for ambient $T > 10\text{ }^{\circ}\text{C}$,
 - from 15 to 20 minutes for ambient $T < 10\text{ }^{\circ}\text{C}$;
- for repair joints on pipes of any size or pressure not subject to hydraulic testing:
 - 1 hour for each atm of applied pressure;
- for joints in pipes and fittings of any diameter subject to pressure testing up to PN 16:
 - minimum 24 hours.

The solvent cement setting times indicated are valid at ambient temperature (approximately $25\text{ }^{\circ}\text{C}$). For particular climatic conditions (humidity, temperature and so on), we recommend you contact our technical services department and the solvent cement manufacturer for more

Amount of solvent cement for CPVC material

The amount of solvent cement used on the joints depends on a number of factors (environmental conditions, pipe size, cement viscosity, operator experience, etc.) which are often difficult to quantify.

In this respect, the next table reports the approximate quantities of cement normally used for joining diameter pipes and fittings in CPVC.

D (mm)	Number of joints per kg of solvent cement
16	550
20	500
25	450
32	400
40	300
50	200
63	140
75	90
90	60
110	40
160	15
225	6

3.1.1.3 Solvent welding of piping system in ABS

The ABS material, used in a wide application field which ranges from aggressive fluids to slurries to alimentary fluids, has the following main features:

- optimal wear resistance (suitable to convey corrosive slurries and abrasives);
- low superficial roughness which reduces strongly the fluid friction loss and the growth of encrustation and erosion;
- wide application field of temperatures (between -40 and $+60^{\circ}\text{C}$);
- high impact resistance: ABS lightens ductile behaviour down to -40°C ;
- perfect compatibility with alimentary fluids.

During the installation of pipelines in ABS the previously mentioned indication for solvent welding of UPVC and CPVC is to be remarked.

Unless otherwise specified, the solvent cement used on the surfaces to join must also be usable with the following tolerances:

- maximum interference 0.6 mm;
- maximum clearance 0.2 mm.

Therefore the following table reports the test values related to the resistance to the internal pressure of the glued connections are reported, according to ISO 15493 and with a safety factor of 1.8.

Test temperature ($^{\circ}\text{C}$)	Min. test duration (h)	Test pressure (kg/cm^2)
20	1000	2 x PN

As described for the other materials, even for ABS it isn't allowed any possibility to join directly pipes and accessories of other materials, so the solvent welding is often connected to movable joints.

As regards the glueing of ABS items, it should be carried out with glue type DURAPIPE ABS.

Moreover it is suggested, after treatment with suitable abrading paper, the use of a cleaner type MEK (Methyl-Ethyl-Ketone) before proceeding with the glue application.

Welding instructions for the longitudinal connection of pipes and fittings in ABS

Before starting any solvent welding operations, the efficiency and condition of the equipment used and the pieces to be assembled must be verified, in particular the uniformity, fluidity and expiry date of the solvent cement.

No attempt should be made to increase the clearance between the pipes and fittings. The jointing procedure detailed below must be followed:



1) The pipe must be cut clean and square. A suitable wheel cutter will eliminate swarf.



2) Chamfer the end of the pipe using a coarse file or suitable chamfering tool. The chamfer should be approximately 45° by 3 mm to 5 mm depending on the pipe size.



3) Mark the pipe a known distance from the end and clear of the area to be cleaned, as shown in the picture. This mark should be used to confirm full insertion of pipe into socket of fitting.



4) Ensure that joint surfaces are clean and free from moisture. Clean surfaces thoroughly with Durapipe Eco-cleaner using lint free cloth or a paper towel.



5) Using a clean brush apply cement to the pipe and fitting.

The joint surfaces should be completely covered by cement. Cement should be applied using an appropriate size brush and tin of cement. It is important to apply cement quickly to enable assembly without excessive force being required. When applying cement with brush, the size of the brush should be approximately half the size of the pipe to be jointed: brush size up to 63 mm for 0,5 litre and up to 75 mm for 1 litre tins.



6) Pipe must be inserted into the fitting or valve immediately after application of the solvent, without rotation; only after reaching the insertion depth provided, it is possible to rotate up to a maximum of 1/4 turn between tube and fitting. Hold the pipe and the fitting for times varying from a few seconds up to 1 minute according to the size. The slight taper moulded into the fitting may otherwise cause it to slide off the pipe with consequent loss of joint strength. Application of the correct amount of cement will result in a neat bead of cement at the edge of the fitting and at the edge of the pipe. Excessive deposits inside the fittings must be avoided as these can weaken the wall, particularly on smaller sizes.

When working under cold conditions make sure the joints are free from frost and moisture.



7) Wipe off excess cement from the outside of the joint.



8) Using the mark previously made, check that the pipe has been fully inserted.

9) Do not touch the joint for least 10 minutes.

On larger sizes do not subject the joint to bending or twisting forces for at least 4 hours.

When making subsequent joints, which can be done without waiting, take care not to transmit forces to freshly made joints in the system.

The drying times will vary with fit, amount of solvent cement applied, ambient temperature and working pressure. It is recommended that, wherever possible, joints of sizes up to 225 mm are allowed to dry for at least 24 hours, and sizes of 250 mm and 315 mm for at least 48 hours.

These guidelines are based on an ambient temperature of between 10°C to 40°C.

Longer drying times will be required at lower and higher ambient temperatures.

A working guide where the ambient temperature is between 10°C to 40°C and the contents temperature does not exceed 20°C is as follows:

Size Range	Up to 75 mm	From 90 mm to 125 mm	From 140 mm to 160 mm	From 200 mm to 225 mm	From 250 mm to 315 mm
Drying Time	0.5 h/bar	1 h/bar	1.5 h/bar	2 h/bar	48 h minimum

NOTE: minimum drying period should never be less than 1 hour.

It is necessary to remember that drying times should be extended where ambient temperatures are below 20°C and that solvent cement joints should not be made below 0°C.

For more details contact the Aliaxis Technical department.

Amount of solvent welding for ABS material

The amount of solvent cement used on the joints depends on a number of factors (environmental conditions, pipe size, cement viscosity, operator experience, etc.) which are often difficult to quantify.

In the following table it is possible to find an indication of the number of joints in ABS to be made per litre of cement.

Size (mm)	Recommended container size	Joints per litre of ABS
16-32	0.5 litre	400
40-63	0.5 litre	200
75-110	0.5 litre	70
125-140	1 litre	20
160-225	1 litre	10
250-315	1 litre	5



GENERAL WARNINGS FOR SOLVENT WELDING

During the solvent welding, it is suggested to follow the advice below:

- 1)** In the case where the external diameter of the pipe and the internal diameter of the fitting are at opposite extremes of their tolerance values, the dry pipe cannot be inserted in the dry socket of the fitting. Insertion will only be possible after having applied the Cleaner and Solvent Cement to both parts to be joined.
- 2)** When using the Cleaner and Solvent Cement, the following precautions should be adopted:
 - use gloves and safety glasses to protect hands and eyes;
 - use the Cleaner and Solvent Cement in a working environment with sufficient ventilation to avoid the formation of pockets of air containing concentrations of evaporated solvent, which can irritate the respiratory tract and eyes;
 - due to the volatile nature of the solvents in the cleaner and cement, the containers must be closed immediately after use;
 - solvents in the gaseous phase tend to form flammable mixtures. Therefore, remove any ignition sources such as welding operations, accumulation of electrostatic charges, from the work area, and do not smoke. In all cases, it is advisable to adhere strictly to the solvent cement manufacturer's instructions written on the packaging;
 - in order to prevent a deterioration in the performance of the cleaner and solvent cement, the joining operations should be carried out within an ambient temperature range of between + 5 and + 40° C;
 - to achieve the correct speed of application on sizes of 140 mm and above, cement should be applied simultaneously to pipe and fitting, by two people.
- 3)** After having completed all the joints and prior to putting the lines into service, make sure that the insides of the pipes and fittings are completely free of any solvent traces or vapours. This will prevent contamination of the fluids conveyed.
- 4)** It is suggested to avoid the laying in the trench for pipelines longitudinally jointed since less 10-12 hours from the end of the operation.
- 5)** Avoid tightening completely the flanged connections until the foreseen drying time hasn't concluded.
- 6)** The solvent welding of Aliaxis ball valves shall be preferably carried out with the valve body disconnected from the rest of the line, in order to avoid glue drops on the sealing items.
- 7)** In order to avoid contamination on the conveyed fluids (drinkable water, foods, beverages), be sure that the lines to be put in service would be completely evacuated by solvents vapours eventually present inside the pipelines.
- 8)** During the installation of valves in vertical lines, it is suggested to carry out the solvent welding with the shutting items disconnected from the valve body, due to the normal (internal) solvent dropping.
- 9)** Please note also that the longitudinal joints with solvent maintain unchanged the mechanical features of the base material. Eventual anomalies must be attributed to a not perfect welding execution (the causes can be found out from the analysis of each single case).

Advantages and applications

Solvent welding can be used in several different applications, such as in pumping, drainage and vent, in building sewers and underground systems. One of its most characteristics is that this kind of welding allows to obtain a homogeneous and continuous joint. It can be very useful if working with sensitive material, because it does not require high temperature.

Moreover, as described before, it maintains life expectancy and chemical resistance of the material used and it is easy to master and cost effective, since no expensive tools are needed.

Most common defects

The most common types of defect found if the correct solvent welding procedure is not followed are listed in the following table.

Solvent cement too fluid (incorrect diluent addition)	
Immediate effect	Cementing failure
Consequence	Joint separation or leaks from between the pipe and fitting
Excess solvent cement	
Immediate effect	Internal and external runs beyond the joint zone
Consequence	Weakening of the outer surface of the joint area and formation of bubbles with micro-cracks/sources of fracture in the base material
Excessively dense solvent cement due to evaporated solvent	
Immediate effect	Cementing failure.
Consequence	Joint separation or leaks from between the pipe and fitting Possible surface cracks triggering cracks in the base material
Insufficient and/or incorrect distribution of solvent cement	
Immediate effect	Cementing failure or local weakness
Consequence	Joint separation or leaks from between the pipe and fitting
Incorrect pipe insertion (incomplete, excessive, misaligned)	
Immediate effect	Imperfect joint
Consequence	Transmission of mechanical stresses from the pipe to the fitting and/or leaks from the joint
Impurities and/or humidity on the surfaces of the parts to join	
Immediate effect	Imperfect joint
Consequence	Joint separation or leaks (fluid seepage) from between the pipe and fitting

The Standard EN 14728 classifies imperfections that may be encountered in thermoplastic welded joints.

The following pictures describe respectively:

- A** - an incorrect distribution of solvent cement (there are areas where there is no solvent cement at the pipe/fitting interface);
- B** - foreign material trapped in weld, due to the presence of impurities on the surfaces of the parts to join;
- C** - an incomplete pipe insertion.

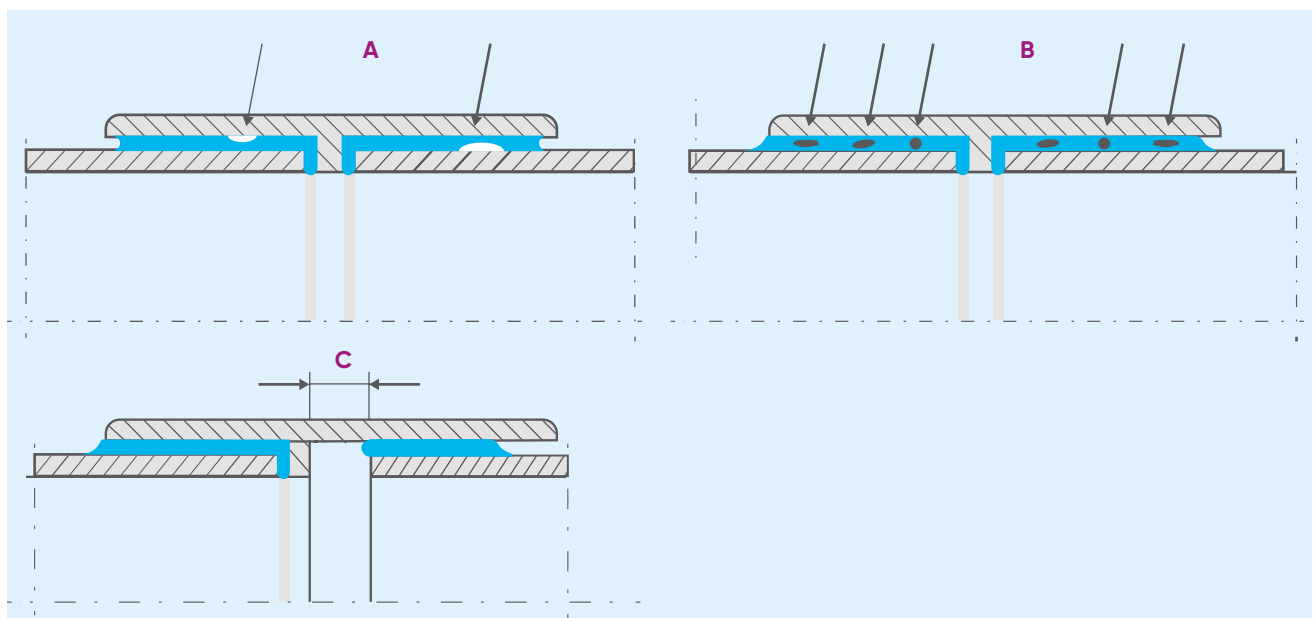

3.1.2 Butt Welding

Butt welding with contact heating elements is the process of joining two elements (pipes, fittings or valve end connectors) of the same diameter and thickness, the joining surfaces of which are heated until fusion by contact with a heating element and then, after the heating element has been removed, are pressed together to form the weld.

The following instructions are provided for reference purposes only. Installers must be properly trained and have an in-depth knowledge of the procedures to be followed according to the type of welding equipment being used.



Welding instructions

To ensure the joint is made properly:

- ambient temperatures must be within the range from +5 °C to +40 °C;
- when inspecting the elements to be welded together, check the dimensions (check for excess ovality);
- check the working temperature of the heating element with a calibrated contact thermometer. This measurement must be made 10 minutes after the rated temperature has been reached, thus allowing the element to heat up over its entire surface area and depth. Fusion temperature must be between 200° C and 220° C;
- check the surface of the heating element (integrity of the non-stick coating) and clean with a lint-free cloth or soft paper wipe;
- check that the welding unit is functioning correctly;
- check the efficiency of the welding unit jaw clamps; ensure they are able to guarantee the correct alignment between the two sides of the joint and that the contact surfaces are perfectly parallel;
- check the pulling force of the carriage, both in terms of friction and in relation to the load to be moved, pipes or fittings;
- check the efficiency of the measuring instruments (pressure gauge and timer);
- check that the pipes and/or fittings to be welded together are of the same diameter and thickness (same SDR);

Below are the step by step instructions on how the pipe and/or fitting material is being prepared for the butt welding.



1) Before positioning the parts to be welded, remove all traces of dirt, grease, oil and dust from the external and internal surfaces of the ends, using a clean, lintfree cloth soaked in a suitable detergent. When choosing the type of liquid detergent, use recommended products supplied by specialist producers: trichloroethane, chloroethene, ethyl alcohol and isopropyl alcohol are all suitable.

2) The ends of the two parts to be welded must be clamped in such a way that axial misalignment does not exceed 10% of the thickness.



3) To guarantee proper parallelism and flatness, and, equally important, to eliminate the film of oxide that forms, the ends of the two parts to be joined must be planed. When this procedure is concluded, bring the two ends into contact and ensure that any clearances between them do not exceed 0.5 mm.

The shavings must form continuously on both the edges to be welded as shown in the figure.

The butt fusion welding of pipes and/or fittings using contact heating elements must be performed by carrying out all the steps in the welding cycle. The picture below refers to the welding cycle taken from DVS 2207.

NOTE: Pay attention to the changes of values in welding cycle table for different materials. For example, below are the welding cycle table for PP-H, PE and PVDF taken from DVS 2207.

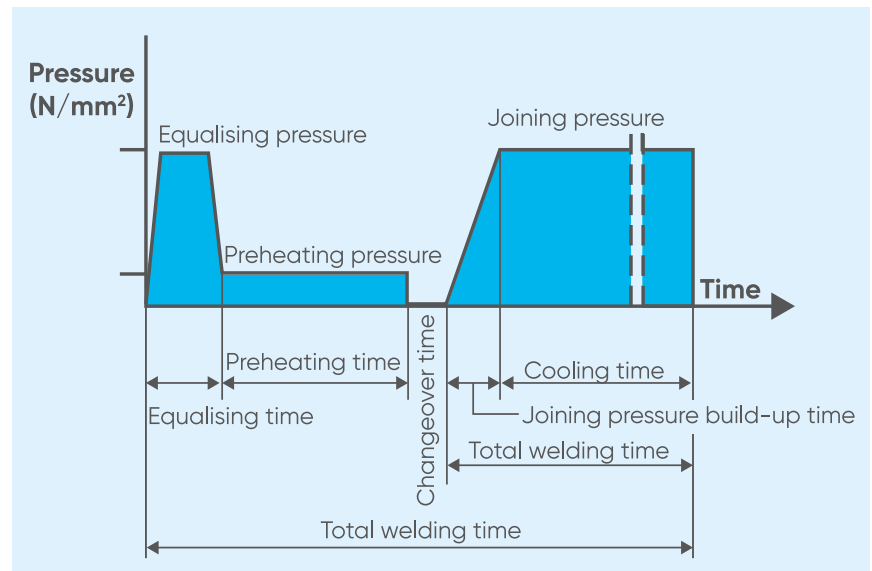

Welding Cycle PP-H

Nominal wall thickness (mm)	Equalizing Bead height on heating element at end of equalizing time (minimum values) (equalizing $p=0.15\pm 0.01$ N/mm ²) (mm)	Preheating Preheating time=10x nominal wall thickness (preheating $p\leq 0.01$ N/mm ²) (sec)	Changeover Changeover time (maximum) (sec)	Joining pressure build-up time (Maximum time, may be undercut by up to 50%) (sec)	Cooling time (minimum values) at joining pressure $p=0.15\pm 0.01$ N/mm ² (min)
up to 4.5	0.5	up to 53	5	6	table below
4.5 - 7	0.5	53 - 81	5 - 6	6 - 7	
7 - 12	1	81 - 135	6 - 7	7 - 11	
12 - 19	1	135 - 206	7 - 9	11 - 17	
19 - 26	1.5	206 - 271	9 - 11	17 - 22	
26 - 37	2	271 - 362	11 - 14	22 - 32	
37 - 50	2.5	362 - 450	14 - 17	32 - 43	
50 - 70	3	450 - 546	17 - 22	43	

Cooling time PP-H

Nominal wall thickness (mm)	Cooling time (minimum values) at joining pressure $p=0.10\pm 0.01$ N/mm ² as a function of ambient temperature			
	Up to 15°C (min)	15°C - 25°C (min)	25°C - 40°C Cooling time (min)	Cooling time (minimum values) at pressure welding $p=0.10\pm 0.01$ N/mm ² in special conditions* (min)
up to 4.5	4	5	6.5	3.5
4.5 - 7	4 - 6	5 - 7.5	6.5 - 9.5	3.5 - 5
7 - 12	6 - 9.5	7.5 - 12	9.5 - 15.5	5 - 8
12 - 19	9.5 - 14	12 - 18	15.5 - 24	8 - 12
19 - 26	14 - 19	18 - 24	24 - 32	12 - 16
26 - 37	19 - 27	24 - 34	32 - 45	16 - 23
37 - 50	27 - 36	34 - 46	45 - 61	23 - 31
50 - 70	36 - 50	46 - 64	61 - 85	31 - 43

* These cooling times apply only under the following conditions:

- welding done in the laboratory/workshop;
- the removal of the part from the welding machine and its temporary storage until it has completely cooled down for the defined time in accordance with the fifth column above causes negligible loading of the joint connection.

Welding Cycle PE

Nominal wall thickness (mm)	Equalizing Bead height on heating element at end of equalizing time (minimum values) (equalizing $p=0.15\pm 0.01$ N/mm ²) (mm)	Preheating Preheating time = 10x nominal wall thickness (preheating $p\leq 0.01$ N/mm ²) (sec)	Changeover Changeover time (maximum) (sec)	Joining pressure build-up time (Maximum time, may be undercut by up to 50%) (sec)	Cooling time (minimum values) at joining pressure $p=0.15\pm 0.01$ N/mm ² (min)
up to 4.5	0.5	up to 45	5	5	table below
4.5 - 7	1	45 - 70	5 - 6	5 - 6	
7 - 12	1.5	70 - 120	6 - 8	6 - 8	
12 - 19	2	120 - 190	8 - 10	8 - 11	
19 - 26	2.5	190 - 260	10 - 12	11 - 14	
26 - 37	3	260 - 370	12 - 16	14 - 19	
37 - 50	3.5	370 - 500	16 - 20	19 - 25	
50 - 70	4	500 - 700	20 - 25	25 - 35	
70 - 90	4.5	700 - 900	25 - 30	35	
90 - 110	5	900 - 1.100	30 - 35	35	
110 - 130	5.5	1.100 - 1.300	max. 35	35	

Cooling time PE

Nominal wall thickness (mm)	Cooling time (minimum values) at joining pressure $p=0.10\pm 0.01$ N/mm ² as a function of ambient temperature		
	Up to 15°C (min)	15°C - 25°C (min)	25°C - 40°C Cooling time (min) (minimum values) at pressure welding $p=0.10\pm 0.01$ N/mm ² in special conditions* (min)
up to 4.5	4	5	6.5
4.5 - 7	4 - 6	5 - 7.5	6.5 - 9.5
7 - 12	6 - 9.5	7.5 - 12	9.5 - 15.5
12 - 19	9.5 - 14	12 - 18	15.5 - 24
19 - 26	14 - 19	18 - 24	24 - 32
26 - 37	19 - 27	24 - 34	32 - 45
37 - 50	27 - 36	34 - 46	45 - 61
50 - 70	36 - 50	46 - 64	61 - 85
70 - 90	50 - 64	64 - 82	85 - 109
90 - 110	64 - 78	82 - 100	109 - 133
110 - 130	78 - 92	100 - 118	133 - 157

Welding cycle PVDF

Nominal wall thickness (mm)	Equalizing Bead height on heating element at end of equalizing time (minimum values) (equalizing $p=0.10 \text{ N/mm}^2$) (mm)	Preheating Preheating time = $10 \times$ nominal wall thickness (preheating $p \leq 0.01 \text{ N/mm}^2$) (sec)	Changeover Changeover time (maximum) (sec)	Joining pressure build-up time (Maximum time, may be undercut by up to 50%) (sec)	Cooling time (minimum values) at joining pressure $p=0.10 \pm 0.01 \text{ N/mm}^2$ $t \approx 1.2 \times$ wall thickness + 2 min (min)
1.9 - 3.5	0.5	59 - 75	3	3 - 4	5 - 6
3.5 - 5.5	0.5	75 - 95	3	4 - 5	6 - 8.5
5.5 - 10	0.5 - 1	95 - 140	4	5 - 7	8.5 - 14
10 - 15	1 - 1.3	140 - 190	4	7 - 9	14 - 19
15 - 20	1.3 - 1.7	190 - 240	5	9 - 11	19 - 25
20 - 25	1.7 - 2	240 - 290	5	11 - 13	25 - 32

Hereby, the steps of the welding cycle are described.

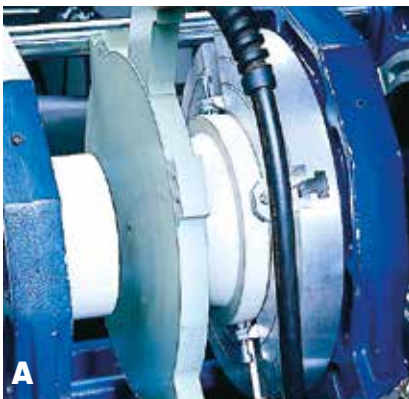

1) As shown in the welding cycle, equalizing is the first step, where the two edges to be welded are located against the heating element at a pressure equal to $p_1 + p_t$, for the necessary time, with the purpose of creating a uniform internal and external bead (picture **A**).

This equalizing step is finished when the bead heights around the entire pipe circumference have reached the values specified in the previous table.

The equalizing pressure value must be such that, when in contact with the heating element, the surfaces to be welded are subjected to the pressure described in the table; to achieve this condition, p_1 pressure values must be taken from the tables supplied by manufacturer of the fusion joining machine, because, apart from the diameter and thickness of the elements to be welded, these values also depend on the cross section of the thrust cylinder in the welder circuit and can therefore alter in accordance with the specific model of welding unit you are using.

The symbol p_t indicates the pulling pressure required to overcome the friction offered by the welding unit and the weight of the pipe locked in the mobile guide, combining to impede the free movement of the guide. This reading is taken on the pressure gauge supplied with the machine, while moving the mobile guide (picture **B**).

In any event, it must never be higher than the pressure value p_1 , otherwise it may prove necessary to use carriages or suspension systems to facilitate movement of the pipe.





2) After the bead has formed, during the preheating step, the pressure is lowered, as can be seen in the table (about 10% of the previous value), thus allowing the material to heat up uniformly through its entire depth.

3) The changeover phase must be performed as rapidly as possible, detaching the pipe edges to be welded from the heating element, extracting the element without damaging the softened surfaces and then immediately bringing the two edges to be welded into contact with each other.

Note: This procedure must be performed quickly to avoid the risk of excessive cooling of the edges (surface temperature falls by 17 °C in just 3 seconds).

4) In the jointing build-up period the two edges are brought into contact as shown in the picture and the relative pressure is increased progressively to the value $(p_5 + p_t)$, where $p_5 = p_1$ and p_t is the pulling pressure.



5) Welding pressure must be maintained for the time described in the cooling time for joining pressure column. The picture below portrays how the welded region looks like after its being welded.

6) Once the joint has been welded, contact pressure is removed and the joined parts can be removed from the fusion jointing machine, although it must not be subjected to mechanical stress until it has cooled completely.

Time requested to get a complete cooling is the same described in the table in "Cooling time" column.



WARNINGS

During the butt welding, take care of the following recommendations:

- Always wear appropriate personal protective equipment (for example, gloves and safety glasses to protect hands and eyes).
- Follow all the safety instructions specified by welding equipment manufacturer.
- It is a good practice, after the planing stage, to inspect the resulting shavings to verify the absence of manufacturing defects. Shavings must be removed from the internal surface of the components to be welded using a brush or a clean cloth.
- In any event, after planing, the two surfaces must not be touched or contaminated in any other way; for this reason, the welding operations must be performed immediately after preparation.
- If any traces of dust have settled on the planed surfaces, before they can be welded, they should be cleaned with a cloth soaked in specific detergent.

Advantages and applications

Butt welding is well suitable for wide range of section sizes and complex shapes as this technique stands more economical especially for the components whose diameter exceeding 200mm. In addition, this welding technique does not require any additional fittings for joining and the equipment could be operated fully or semi-automatic.

The butt-welded components are being mainly used in the construction sites and also its typical applications include repair in water utility and chemicals.

Checking the quality of the welded joints

Joints can be checked using two alternative techniques: non-destructive tests and destructive tests. While these latter tests call for the use of special equipment, the quality of the joint can also be checked with a simple visual inspection. Visual inspections should assess the following points:

- the weld bead must be uniform around the entire circumference of the joint;
- the notch in the center of the bead must remain above the outside diameter of the welded parts;
- the external surface of the bead must not show any signs of porosity or inclusions of dust or other contaminants;
- there should be no visible signs of surface breakup;
- the surface of the weld bead should not have a very highly reflective finish, as this is a sign of overheating;
- axial misalignment of the welded parts must be no greater than 10% of their thickness.

Most common defects

The table below reports the most common types of defect encountered if the correct welding procedure is not followed.

Irregular path of the weld bead around the circumference of the pipe	
Possible causes	Insufficiently meticulous preparation of ends to be welded with consequent uneven heat distribution
Reduced size of weld bead	
Possible causes	Incorrect adjustment of welding parameters (temperature, pressure and time)
Notch in centre of bead is too deep	
Possible causes	Temperature or pressure values are too low
Inclusions in the surface of the weld bead	
Possible causes	Insufficient cleaning of the ends to be welded
Porosity of weld bead	
Possible causes	Welding performed in excessively humid ambient conditions
Surface of weld bead presents an excessively smooth shiny finish	
Possible causes	Overheating during welding
Misalignment exceeds 10% of the thickness of the pipe and the fitting	
Possible causes	Incorrectly executed centring or excessive ovality of pipe

Infra-Red Welding

Infrared (IR) welding is a technique of non-contact thermal welding that creates extremely solid welds that are airtight & liquid tight. Infrared radiation is most generally referred to as the heat from sunlight, and as with any source of light, electromagnetic radiation is emitted at extremely high levels of intensity.

As a deliberate heating source, infrared radiation may be used, making it more common in industrial and semiconductor production processes. Thermoplastic components can be heated very easily to molten temperatures as these wavelengths can be regulated (IR Welding) and then joined together similarly to hot plate welding (socket fusion, butt fusion).

Welding Instructions

During infrared welding, both part halves are held rigidly in position near an infrared emitting platen.

The platen then emits powerful infrared light into both parts along the determined joint path, usually a circle or line. The platen is quickly removed, and the part halves are immediately driven together and allowed to re-solidify under pressure.

The fusion joints generated from Infrared welding are homogeneous and exhibits good characteristics.

Advantages and applications of Infra-Red welding

One of the biggest advantages of this welding technique is it allows a greater design flexibility in material choice (no contact applications). Since, this technique involves as no contact applications thereby eliminates the replacement of inserts/coating material for the platen (heater) to prevent adhesion with the parts. Moreover, this technique is 50 % faster than butt fusion welding. There's no or minimal risk of contamination and bead formation is also very minimal. Due to very uniform heating the stress formation at the weld joints is very less.

The typical application areas of Infra-Red welding are for example, components which has irregular and more complex shapes.

3.1.3 Socket Welding

Hot socket welding is a methodology which involves fusing the pipe in the fitting's socket. The joint is made by simultaneously fusing the male and female surfaces by means of special manual or automatic heating devices. These devices, in their simplest form, are composed of a heating plate on which a series of heating bushes are assembled. The devices come with an appropriate heating system complete with an automatic temperature controller. No additional materials are required for this type of welding. Socket welding does not affect the chemical resistance of the material, nor does it influence the inner pressure resistance of the assembled pipes and fittings. The pipe to be welded must be cut, chamfered and peeled if necessary. The external surface of the pipe and the internal surface of the fitting must be carefully cleaned, and the external surfaces of the pipe and fitting can be marked with a reference notch to eliminate the risk of inadvertent rotation while the joint is setting. The next step is to insert the pipe in the female bush and the fitting in the male bush and hold them in position for the necessary heating time; when this time has elapsed, the parts must be quickly removed from the bushes and then the pipe inserted into the fitting to the full previously determined insertion length, ensuring the reference notches are correctly aligned. The two elements must be supported for approximately 15 seconds after initial insertion and then left to cool at ambient temperature without using forced air flows or water immersion.



Welding instructions

The method described below is applicable only when creating thermal socket welds that call for the use of manual type welding equipment.

The use of automatic and semi-automatic appliances, which are particularly suitable for diameters greater than 63 mm, calls for a specific working knowledge of the welding tool. In this case, adhere strictly to the tool manufacturer's instructions.



1) Select the female bushes and the male bushes of the required diameters, insert them and secure them to the heating plate as shown in the picture.



2) Carefully clean the contact surfaces as shown in the picture. When choosing the type of liquid detergent, use recommended products supplied by specialist producers: trichloroethane, chlorothene, ethyl alcohol and isopropyl alcohol are all suitable.



3) Set the temperature of the heating tool. To form the joint correctly, the temperature should be set between 250° C and 270° C.

4) When the appliance has reached the preset temperature, check the temperature of the heating plate using a fast acting thermoprobe.

5) Cut the pipe (picture **A**), chamfer it and if necessary, peel it out (picture **B**).



The peeling diameter and length and the chamfer depth must correspond to the values shown in the Pipe peeling and chamfer dimensions table reported below. The chamfering process can be performed either after peeling or concurrently with this operation, using special calibrated tools.

Pipe peeling and chamfer dimensions PP-H

External diameter D_e (mm)	Peeling length L_p (mm)	Chamfer S_m (mm)
20	14	2
25	16	2
32	18	2
40	20	2
50	23	2
63	27	3
75	31	3
90	35	3
110	41	3

Pipe peeling and chamfer dimensions PVDF

External diameter D_e (mm)	Peeling length L_p (mm)	Chamfer S_m (mm)
16	13	2
20	14	2
25	16	2
32	18	2
40	20	2
50	23	2
63	27	3
75	31	3
90	35	3
110	41	3



6) Mark the pipe with the insertion length L_i as shown in the picture, referring to the values indicated in the pipe insertion length table reported below.

Pipe insertion length PP-H

External diameter D_e (mm)	Length of insertion into the fitting's socket L_i (mm)
20	14
25	15
32	17
40	18
50	20
63	26
75	29
90	32
110	35

Pipe insertion length PVDF

External diameter D_e (mm)	Length of insertion into the fitting's socket L_i (mm)
16	12
20	14
25	15
32	17
40	18
50	20
63	26
75	29
90	32
110	35



7) Mark a longitudinal reference line on the outside of the pipe and the fitting to prevent the two parts from rotating while the joint is being made as shown in the picture.



8) Clean the fitting and pipe from any traces of oil or dust on the weld surfaces.



9) After having checked that the surface temperature of the heating plate has stabilized at the required value, insert the pipe into the female bush and the fitting in the male bush as shown in the picture.

Holding the parts inserted in the two bushes (fitting inserted to limit stop, pipe inserted up to the end of the peeling length), wait for the minimum heating time shown in the Heating, welding and cooling times table reported below which are all taken from DVS 2207.

De (mm)	PP pipes according to: DVS 2207 Part 11			
	Minimum thickness* (mm)	Heating time (sec)	Change over time (s)	Cooling time (min)
20	2.5	5	4	2
25	2.7	7	4	2
32	3	8	6	4
40	3.7	12	6	4
50	4.6	18	6	4
63	3.6	24	8	6
75	4.3	30	8	6
90	6.1	40	8	6
110	6.3	50	10	8

* For proper welding, we recommend using pipes with wall thickness exceeding 2 mm, and precisely:

- for De up to 50 mm: pipe series PN 10 and PN 16;
- for De from 63 to 110 mm: pipe series PN 16, PN 10 and PN 6.

Heating, welding and cooling times PVDF

De (mm)	PVDF pipes according to: DVS 2207 Part 15			
	Minimum thickness* (mm)	Heating time (sec)	Change over time (s)	Cooling time (min)
16	1.5	4	4	2
20	1.9	6	4	2
25	1.9	8	4	2
32	2.4	10	4	4
40	2.4	12	4	4
50	3	18	4	4
63	3	20	6	6
75	3	22	6	6
90	3	25	6	6
110	3	30	6	8

* For proper welding, we recommend using pipes with wall thickness exceeding 2 mm, and precisely:

- for De up to 50 mm: pipe series PN 10 and PN 16;
- for De from 63 to 110 mm: pipe series PN 16, PN 10 and PN 6.



10) When the minimum heating time has elapsed, quickly remove the elements from the bushes and fit the pipe into the fitting for the entire insertion length L1 marked previously as in the figure. Do not turn the pipe in the fitting; ensure the longitudinal reference marks are perfectly aligned as you can see in the picture below.

11) According to the table named "Heating, welding and cooling times", hold the jointed elements for the welding time, called "Changeover time". Then let them to cool down for the "Cooling time". It is important to remark that this step should be at ambient temperature and without using forced air flows or water immersion.

12) When the internal and external surfaces have cooled sufficiently, pressurize the plant for the joint hydraulic test.



WARNINGS

During the socket welding, take care of the recommendations below:

- always wear appropriate personal protective equipment (for example, gloves and safety glasses to protect hands and eyes);
- follow all the safety instructions specified by welding equipment manufacturer;
- with socket fusion joining strategy there is no compensation can be possible for joint orientation or depth errors because joint cooling happens so rapidly that once pipe penetration into the socket attachment is halted, correction cannot be performed;
- when there is a limited working space and the number of joints to be made is less, we suggest that the piping system must be prefabricated, as much as possible, where the heating tool can be secured in a bench vise;
- the joints which are made properly with good alignment and joint depth are very challenging to perform physically. This is particularly true for freehand final joints where the Heat-Tool is carried by one of the joining team members, another pushes a socket attachment to the male Heating Anvil (heat face set), while the pipe is forced into the female Anvil by the third team member. To melt those components on/in the Anvils, a stout but steady force is needed, and they will only go on/in when melted, regardless of axial force. The real challenge is maintaining the force to drive the socket attachment fast enough and straight enough into the pipe, so that the orientation of the pipe and penetration depth into the socket is correct. We therefore propose that any preparation attempt to prefabricate all the joints on the Bench-Mount Joining Machine be made feasible;
- socket connections can be field checked for valid socket dimensional tolerances before making socket thermo-fusion joints. If there happens to be an oversize socket connection, it cannot be used;
- molten plastic material is capable of causing significant burns. Prevent interaction with the heat-tool and the hot plastic. When the installers have to leave the work area, it is often a smart idea to fold a thermal blanket over a hot heat-tool-handhold or bench-mount. A-Caution Hot-Sign is ideal when absent, also delicately written on a cardboard box flap and posted on the workbench;
- when setting up the Hand-held Heated tool, the instructions following must be taken at most care. Heat-Tools at the plant are pre-set at 250 °C to 270 °C. By turning the thermostat adjustment screw with the instrument included in the Hand-Held Joining Kit, the tool temperature can be changed. This instrument is identical to a blade of a screwdriver, the shank of which has been twisted 90 °C. The temperature will be lowered by a clockwise rotation, while the temperature will be increased by a counterclockwise rotation.

Advantages and applications

Socket welding method plays a crucial role where less machinery is required. Since, the technique uses more contact surface area during welding, reduces the time needed to heat and fuse the pipe. Moreover, this welding technique requires less pressure than butt welding.

The typical application areas of socket welding are for example, water and gas services, irrigation systems, chemical process and waste and so on.

Checking the quality of the welded joints

The torsion shear test and radial peeling test are applicable for a quick check of the quality of socket welding pipe connections. The wall thickness of the pipe should be ≥ 4 mm.

- Torsion shear test: the torsion shear test is used for the evaluation of the fracture behaviour and the fracture appearance of the welding joint. For this purpose, the test sample is fixed completely in a bench vice with one part e.g. socket cross section. The other part e.g. pipe cross section, is caught with a suitable tool and twisted for 90° in the welding section. The pitch rate is very low in order to widely exclude the fracture behaviour of the test sample. The clamping areas should be slightly undercut in order to insert the twisting moment directed to the welding joint section.
- Radial peeling test: for this test the pipe cross section of the test sample which is fixed by the socket cross section in the winch vice by means of a suitable pliers or another clamping device is radially peeled at possibly low speed. For evaluation refer the table below.

Evaluation criteria for torsion shear and radial peeling test

Fracture behaviour	Type, Characteristic	Evaluation
High release forces, ductile fracture, > 80 % of the welding zone	Very structured fracture appearance with plastic and ductile yield	Minor faults
Welding zone is partly or completely melt, but only spot-welded	Isolated delamination, contaminations, insufficient surface peeling	
Brittle fracture	Release zone is large-pored, fine structured, interspersed with a lot of voids, partly burnt, overheated welding joint	Unacceptable faults
	Pipe surface is not melt, welding joint too cold, too large welding gap	

Most common defects

- In-correct turning of the adjustment screw of Heating-Tool results burning of the heating element.
- Performing welding before making sure that there are no contaminations present on the surfaces to be welded.
- Improper clamping may result in the misalignment of the pipe.
- Performing welding under undesired working conditions, (e.g. ambient temperature, heating tool temperature, etc) leads to the undesired joint results.

3.1.4 Electrofusion

Electrofusion is a very safe and user-friendly welding technology, mainly used for PE pipes in gas, water, sewage and industrial applications. The heating element is formed of wire and an inherent part of couplers, shapes and many other types of fittings and valves.

When a current is applied to the welding wire, thanks to the Joule effect, the surrounding plastic is heated to 200 °C. The inside of the socket and the outside of the pipe would melt and converge. Temperature control or fusing time control is applied to reach the proper amount of melt, and to stop the heating at the right point of time. When cooling down, the plastic fuses to create a solid and homogeneous connection without any additional sealing material or gasket.

Electrofusion can be used with polyolefin materials showing a semi-crystalline microstructure, like PE80, PE100, PE100-RC, PE-X, PP, PB or PA.

It is the most currently used welding technique to assemble PE pipes and some multi-layer pipes.



Welding Instructions

Below are the step-by-step instructions on how the electrofusion welding is carried out.



- 1) Measure and mark the insertion depth of the pipe into the fitting.
- 2) Scrape the ends of the tubes by a rotation scraper to remove the oxidized surface layer, allowing the clean material to come into contact with the fitting.
- 3) Clean the pipe ends and the internal face of the fitting with an approved cleaner.
- 4) Re-new the marking of the insertion depth to allow monitoring during the electrofusion process
- 5) Insert the ends of the pipes into the fitting at the right depth.



6) Secure with pliers and connect the fitting to the electrofusion box using electrical wires.



7) Scan or read the electrofusion barcode and start the procedure. In case of issues during reading of the barcode, the welding parameters can be deduced from the number over the barcode and typed in the welding machine manually.

8) After the procedure has stopped automatically, the connection may not be moved or put under pressure before the cooling time has expired

To carry out the electrofusion welding the proper understanding of the process, equipment and tools associated with it is mandatory. Comprehending the welding instructions for example, understanding of heating time, cooling time, temperature compensation and so on is required for the working personnel.

The picture below shows an example of electrofusion barcode according to ISO 13950. It has to be scanned to start the procedure.

The meaning of numbers in the barcode is the following:

- digits 1 to 8 are used to describe the name of the fitting manufacturer, the type of the fitting, the energy correction applicable to the nominal fusion time, the type and the indication of the cooling time;
- digits 9 to 11 express the diameter of the fitting;
- digit 12 expresses the resistance value (K);
- digits 13 to 14 express the nominal fusion voltage (V);
- digits 15, 16, 17 express the resistance of heating element (Ω);
- digit 18 expresses the variation of resistance (%);
- digits 19, 20, 21 express the heating time (s);
- digits 22 to 23 express the energy correction(%);

Numbers in bold represent the batch number.

To get more information refer to ISO 13950.





WARNINGS

During the electrofusion welding, it is suggested to follow the instructions given below:

- always wear appropriate personal protective equipment (for example, gloves and safety glasses to protect hands and eyes);
- follow all the safety instructions specified by welding equipment manufacturer;
- the surfaces of the pipes to be fused and the interior surface of the fittings must be absolutely clean, dry and free from any grease. These areas must be cleaned with a suitable cleaning agent and exclusively with absorbent, lint-free and non-dyed paper directly before the assembly and after scraping. When cleaning, ensure that no contaminations from the unscraped pipe surface are introduced into the fusion zone;
- if the oxide layer is not removed completely, inhomogeneous, leaking fusion joints may result;
- an excessive swarf removal may result in excessively large annular gap which either cannot or only insufficiently closed by fusion. Please thus regularly check the condition of the blade at the scraper tool. Worn blades must be replaced;
- fusion between different PE qualities like PE80/PE100 or PE100/PE100-RC or PE100/PE-X is possible, while different materials cannot be welded together;
- cooling time is very important to make sure that the desired connection quality is reached;
- care should be given while cutting the pipe. A non-rectangular pipe cutting may cause the heating coil partially not being covered by the pipe which may result in overheating, uncontrolled melt formation or self-ignition.

Advantages and applications of Electrofusion welding

This welding technique is very well suited for polyolefins and other crystalline polymers. Electrofusion is becoming more popular as it covers a large range of diameter components. Moreover, this technique allows repair without having to remove the pipes. Besides, no formation of fusion beads inside the pipe makes this technique a most preferred one. In addition, its automated fusion process control ensures the high process reliability.

The typical application areas of electrofusion welding technique are for example, in building gas, water or sewage lines of PE, or industrial pipelines made of PP or PE.

Larger insertion depth for a perfect result

One of the benefits of using our electrofusion fitting is it has a large insertion depth which makes it highly efficient solution in yielding a good result. It provides extra safety as the pipe ends are held far better during the electrofusion process.

Longer fusion zone for more bite

Another advantage of using our electrofusion fitting is comes due to its longer fusion zone which enables more bite. This aspect eventually yields reduction in the bending stress and also helps preventing from the loss of melting pressure. In addition, it helps in the compensation of pipes that have not been cut right-angled and compensate reverted pipe ends. Longer fusion zones enable larger area to absorb energy. Moreover, it ensures higher stability and higher installation safety.

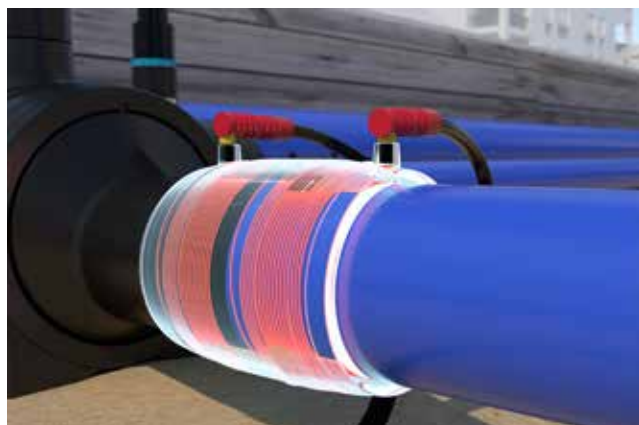

The table below is helpful to better understand the differences between Frialen® fusion zone and the requirements of the European Standard. The table follows DIN EN 12201-3, DIN EN 1555-3 Standards.

De (mm)	Min. fusion zone length (mm) according to DIN EN 12201-3 DIN EN 1555-3	Fusion zone length of FRIALEN (mm)	Ratio
32	10	21	2.1
63	11	29	2.6
125	16	42	2.6
225	26	71	2.7

Exposed heating coil for improved hold

The main advantage of having an exposed heating coil in our electrofusion fitting is to obtain an improved hold. Besides, this aspect yields a lot of other benefits. The oxide skin, which is also present inside the fitting, is much smaller and doesn't affect the welding quality. Moreover, it ensures a quick melting of pipe and fitting surfaces. Heating up and reaching the necessary fusion pressure is performed in the shortest possible time.

Two-thirds of heating coil are embedded into the fitting which avoids any damage of the wire.

The pictures show respectively an example of fitting with exposed heating coil and the final wave formation of the molten material.

During welding

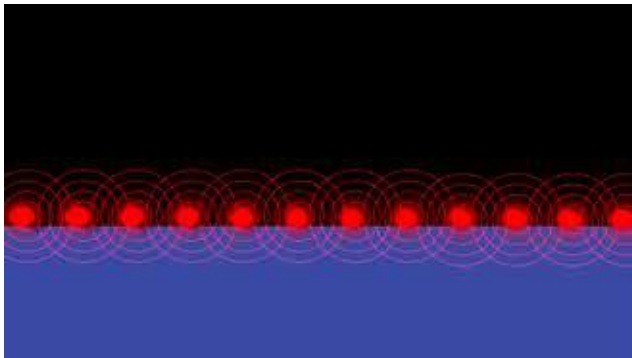

Wave formation after welding

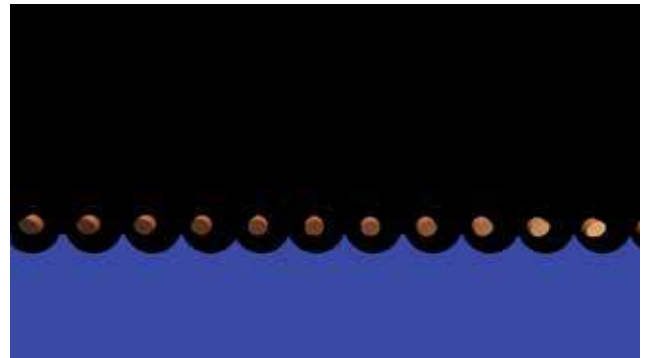

Checking the quality of the welded joint

The PIN indicators of FRIALEN safety fittings indicate if welding has been realised or not.

Before fusion



After fusion



Anyway, to be sure that the fusion has been successful it is suggested to check the fusion box.

Large couplers are equipped with a colour indicator: purple colour is visible after fusion, while the indicator does not show any colours before the fusion.

Most common defects

- A non-rectangular pipe cutting may cause the heating coil partially not being covered by the pipe which may result in overheating, uncontrolled melt formation or self-ignition.
- Pipe surface not being scraped properly is also one of the most common reason for defected joints. Use of proper scraper tools are highly recommended to avoid these kinds of problems.
- In-correct marking of the insertion depth results in a defected joint. For proper marking of insertion depth, make sure that half-length of the coupler plus 5 mm of an additional tolerance is given.
- Paying no attention to re-rounding of pipes when the pipes are not in a shape. Pipes, in particular bundled coils and drums may lose their roundness during storage. If the pipe out of roundness in the fusion zone area exceeds 1.5% of outer diameter or is >3 mm, these pipes must be rounded in the fusion zone area. Use of proper rounding clamps are recommended for re-rounding.
- In-correct use or not using holding devices may results in mis-alignment of the pipe.
- Tilting of the pipe during the insertion, using the same degreaser wipe over and over again and moving a fitting before it has completely cooled may results incorrect jointing.

3.1.5 Hot gas welding

In hot gas welding the joining faces and the outer zones of the weld filler are converted to a plastic state by hot gas, as a rule heated air, and joined together under pressure.

Several materials can be welded by hot gas welding, such as PE, CPVC, UPVC, PP and PVDF.

In general, a hot gas welder is designed to perform three functions: preheating the base material, guiding and preheating the welding rod, and applying pressure to the weld area.

Two different type of welder can be found:

- hot gas welding with torch separate from filler rod (WF): heating is carried out by means of the round nozzle. The bevelled end of the welding wire is held to the start of the welding groove and heated together with the base material. The nozzle is conducted in the direction of the weld so that the current of hot air distributed itself over base material and welding wire. This is conducted in the direction of the weld subjecting the welding wire to as vertical a pressure as possible, as shown in the picture

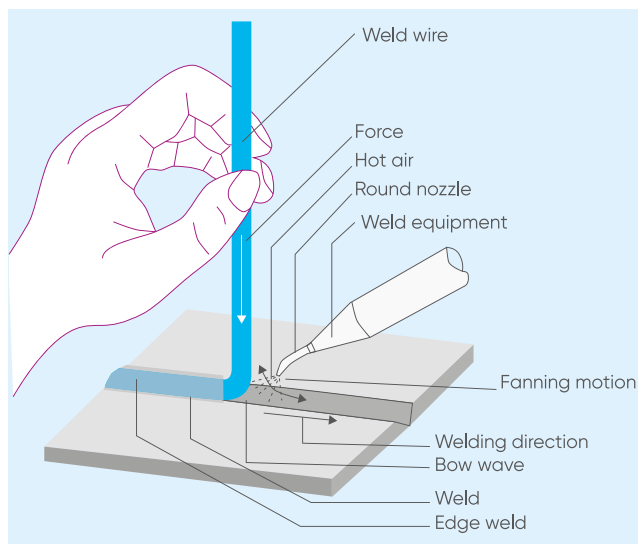

- hot gas string-bead welding (WZ): the welding wire is heated in the stringer nozzle and pressed into the welding groove via a spout-like extension at the lower part of the nozzle. The welding wire is drawn along automatically through the forward movement of the nozzle. The necessary welding pressure can be applied more uniformly and more simply. An example in shown in the picture.

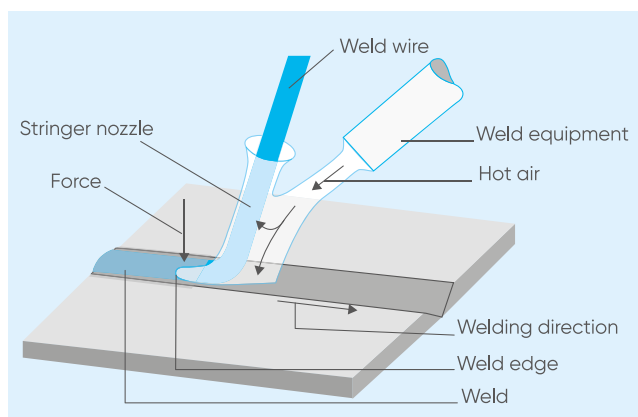

Welding instructions

The quality of the gas used as the heat transfer medium, the pressure and the temperature are critical factors in the quality of the weld.

High-speed hot gas welding requires the use of gas supplied at low pressure and high volume, which is free of oil and moisture.

In the following table, taken from DVS 2207, some recommended values of welding parameters for different materials are listed.

Material symbol	Type of Welding ⁽¹⁾	Welding force (N) with weld wire ⁽²⁾		Hot air temperature °C ⁽³⁾	Quantity of air l/min
		round 3 mm Ø	round 4 mm Ø		
PE-HD	WF	6...10	15...20	300...250	40...60
	WZ	10...16	25...35		
PE-LD (4)	WF			260...320	
	WZ				
PP	WF	6...10	15...20	280...330	
	WZ	10...16	25...35		
PVC-U, PVC-HI	WF	5...9	8...12	320...370	
	WZ	8...12	15...25		
PVC-P ⁽⁴⁾	WF	15...20	18...25	300...370	
	WZ	4...8	7...12		
PVC-C	WF	10...15	15...20	350...400	
	WZ	15...20	20...25		
PMMA ⁽⁵⁾	WF	12...16	12...16	320...370	
	WZ	12...16	20...30		
PVDF	WF	10...15	15...20	350...400	
	WZ	12...17	25...35		

⁽¹⁾ WF = Hot-gas welding with torch separate from filler rod; WZ = Hot-gas string-bead welding.

⁽²⁾ The welding force can be checked by test welding on a sheet balance.

⁽³⁾ Measured in a hot-air current approx. 5 mm inside the nozzle, in the case of orund nozzles in the nozzle centre, in that of stringer nozzles in the main nozzle opening.

⁽⁴⁾ WF is possible in the case of these plastic only with a suitable pad roll.

⁽⁵⁾ Welded with PVC welding filler.

To perform a good rod welding it is necessary to follow these suggestions:

- 1) The ends of the pieces of material to be joined must be bevelled in order to produce the best weld. The bevel may be produced with an adjustable saw, a router or other suitable tool. The angle between the bevels of the two pieces to be joined should be between 60 and 70 degrees, except when one piece is joined perpendicularly to another, in which case, the angle is reduced to 45 degrees.
- 2) The parts to be assembled must be very clean. To remove surface residue, slight grinding or scraping with a sharp blade at the area to be welded and the weld rod is strongly recommended.
- 3) If the joint will not be tacked prior to welding, it is recommended to leave a gap of 0,5 - 1 mm wide between the two pieces to be joined so that the welding material may penetrate to the root of the bevel and overflow slightly on the other side. If the parts will first be tacked, they should be butted together with no gap. The parts to be joined should be mounted firmly in place with appropriate clamps as necessary.

In the following picture typical welded joint configurations are shown.

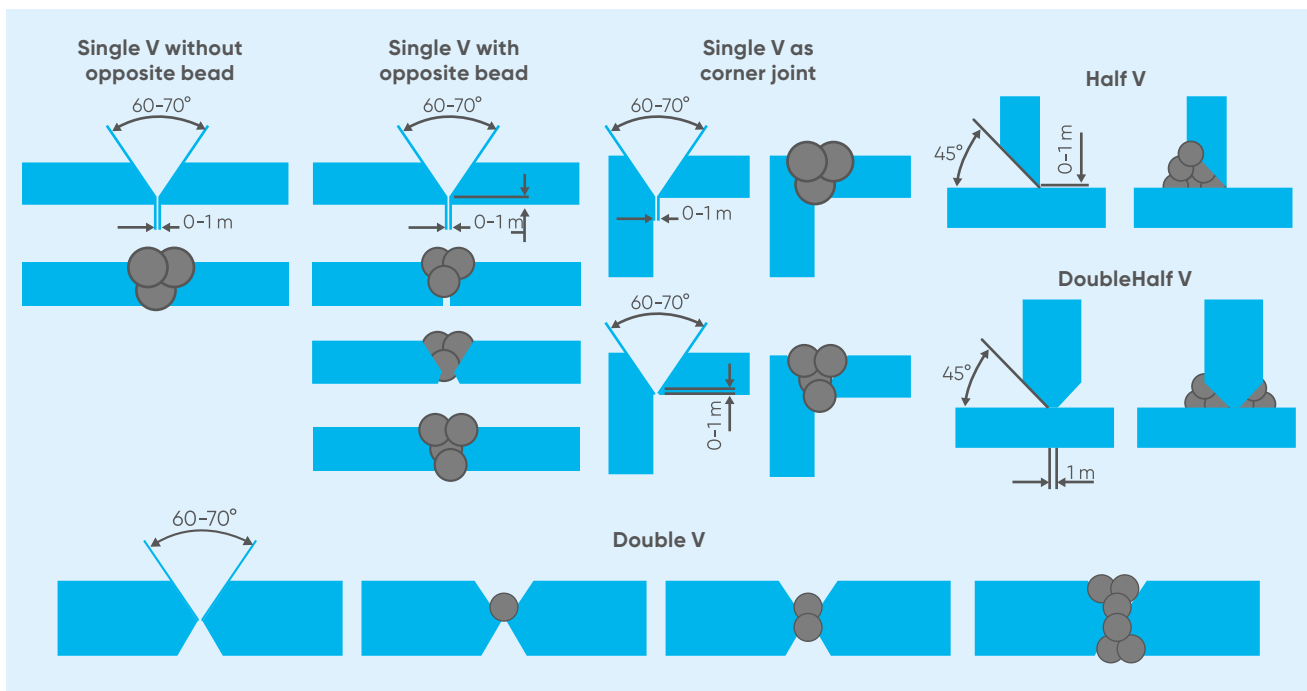

4) To make it easier to start welding, a sharp angle may be cut on the lead end of the welding rod. The welding rod should not be inserted into the high speed-welding tip until immediately before the operator is ready to begin welding, otherwise burning of the rod may result.

5) To begin welding, the operator holds the welding tip above the area to be welded, in order to prevent scorching of the material before work begins, as shown in the picture.



6) Then the operator inserts the welding rod into the preheating tube and places the pointed tip on the material at the starting point of the weld. Holding the welder at roughly a 45 degree angle, it is necessary to push the rod through the tip until it contacts the base material. Once welding begins, it must be continued at a fairly constant rate of speed.

7) To stop welding before the rod is used up, the operator should tilt the welder backward, cut the rod off with the tip of the shoe and immediately remove the remaining rod from the welding tip. Welding may also be terminated by pulling the welder tip up over the remaining rod and cutting the rod.

Multiple beads should be applied as necessary until the joint is completely filled as shown in previous picture. If the joint to be welded is a double V or a double half V joint, the best results are obtained if layers of beads are put down alternately on opposite sides of the joint.

The table presents recommendations for bead lay-up for different material thicknesses and joint configurations.

Material thickness mm		Weld wire number x diameter
Single-V weid	2	1 x 4
	3	3 x 3
	4	1 x 3 + 2 x 4
	5	6 x 3
Double	4	2 (1 x 4)
	5	2 (3 x 3)
	6	2 (3 x 3)
	8	2 (1 x 3 + 2 x 4)
	10	2 (6 x 3)



WARNING

Since temperature and pressure are critical factors in hot gas welding, it is important to carefully follow the indications given on temperature and applied strength to avoid making a wrong weld.

Advantages and applications

Rod welding is used in pipelines for water and gas services, in particular it is suggested for small or particular productions and special works, because it can be applied on many kinds of surfaces and on materials with different shapes. Moreover plastic welds are surely much lighter than mechanical fasteners, so when it is possible it is advisable to prefer this kind of connections to the mechanical one.

Checking the quality of the welded joint

As welding progresses, visual inspection of the weld may indicate its quality: browned or charred edges occur when the welder is moving too slowly or overheating.

If the rod has been softened too much by overheating, it will stretch and break or flatten out.

3.1.6 Flanged Joints

The joint with flanged ends is the most popular removable joint system for the longitudinal connection of large diameter thermoplastic pipes and is particularly suitable for all installations where a rapid disconnection of line components and accessories is expressly required for maintenance and control operations.

This system offers the possibility of connecting equipment and sections of pipes made of different construction materials, provided that the flanges to be coupled have the same drilling template.

The flanges used in the connection of thermoplastic pipes and fittings differ in the different connection system for the type of contact surface where the hydraulic seal of the coupling is implemented; in particular it is possible to find free or fixed flanges:

- **Free flanges:** flanges that are not rigidly connected to the pipe but are free to rotate around its axis. The hydraulic seal of the joint is obtained by compressing special elastomeric gaskets housed between the contact of the support stub ends, the only elements of the coupling system connected directly to the piping with permanent or movable joints.

The particular advantages of this flanging system can be summarized as follows:

- elimination of drilling pre-alignment operations during installation of the junction between flange and pipe.
- possibility to orient around the central axis of the pipeline branch fittings and valves with flanged ends for a complete 360° rotation arc.
- possibility of using flanges of non-homogeneous material with that of the pipes.
- wide availability of support stub ends made of thermoplastic material with different finishing of the sealing surfaces (flat face, serrated face or machine for butterfly valves).

- **Fixed flanges:** flanges that are directly connected to the pipeline with permanent or removable joints. In the case of permanent longitudinal connection (welding with solvent, welding in the socket, butt or electrofusion) the flange and the joint stub end are made of the same construction material as the pipe, while only for longitudinal connections of the mobile type (rubber ring, compression joint, etc.) it is possible to use flanges and stub ends of material that is not homogeneous with the pipe.

Since the joint stub end helps to increase the mechanical strength of the flange, the fixed flanges are particularly suitable for both high pressure applications and for couplings with flat elastomeric gaskets, where the tightening torque of the bolts is particularly high.

Within this group it is possible to find raised face (RF) and flat face (FF) flanges: raised face flange is called in this way because of the raised surface above the bolting circle where the gasket is placed. Sealing this type of flange face is accomplished by compressing a gasket between mating flanges in the raised area of the flanges.

Flat face flanges do not have the raised area like the RF flange. Instead, the whole surface is flat. That means that the gasket used with the FF flange has full contact with the whole surface where two flanges are mated.

Seal shape

Taking into account of the operating conditions and the sealing forces, the selection of suitable flange seals in thermoplastic piping is dependent on the following factors:

- shape;
- dimension;
- material;
- chemical resistance to the medium.

In general, however, it is not possible to determine exactly in advance which type of sealing surface should be used for a particular application, without having previous specific experience on which depending on a relative selection criteria.

Three different contact surfaces are generally used for free flanges with support stub end:

- **sealing surface with flat face:** the flat face sealing surfaces are used in couplings with flat gaskets for conveying non-hazardous fluids at low pressure or in couplings with o-ring gaskets. Fixed flanges with flat sealing surfaces are widely used for coupling with blind flanges in the execution of blind flanged connections for services such as vents and drainages. Moreover they are also used coupled with butterfly valves equipped with a liner seal or clapet valve with o-ring;
- **sealing surface with serrated flat face:** the serrated flat face sealing surfaces have concentric grooves on the gasket bearing surfaces which increase the residual compression of the flat gaskets in high pressure applications. This type of sealing surface is widely used in all flange couplings in transit, where flanges in thermoplastic material are connected to counter flanges in metallic material (cast iron, carbon and alloy steels);
- **sealing surface with seat for elastomeric ring:** these are less common than the previous ones; they are suitable for flanged couplings in thermoplastic material, since limited values of the tightening forces of the bolts are required to obtain a perfect hydraulic seal of the joint.

Seal materials

The gaskets used in flanged joints are classified according to the material and the shape, which is directly related to the type of sealing surface of the flange.

In conveying aggressive industrial fluids ethylene or fluorinated elastomers, such as EPDM and FPM are extensively used due to their high chemical and mechanical resistance even at high temperatures.

Rubbers such as NBR and PTFE, on the other hand, offer great reliability in the transport of drinking water or water to be potable, even if nowadays NBR is little used due to its low chemical resistance.

The selection of the construction material of a gasket depends on the nature of the fluid conveyed in the pipeline and on the operating conditions to which the flanged joint is subjected.

Moreover, the material of a gasket also characterizes the tightening load of the bolts used in the flanged coupling: it is necessary to remember that the use of elastomers denoting different hardness and compression set values requires the application of diversified tightening moments that guarantee the hydraulic seal of the joint.

Since the compression of the gasket depends on the characteristics of the elastomeric material, on the type of contact surface of the flange and on the operating pressure of the piping, it is always advisable, if previous experiences are not usable, to check the tightening loads to be attribute to the bolts.

Choice of bolts

The bolts used for the flanging of thermoplastic pipes consist of fully or partially threaded metal bars, called tie rods, completed by two stop nuts or in normal bolts with totally or partially threaded shank, completed by a tightening nut.

The type and dimensions of the bolts depend on the flange drilling template and on the type of flange connection selected.

Bolts in carbon steels and low alloy steels, denoting unit breaking loads between 50 and 70 kg/mm², guarantees adequate mechanical resistance of the flanged joints, since any metal creep phenomena are assumed non-existent due to the limited operating temperatures to which thermoplastic pipes are subjected.

The use of bolts, nuts and tie rods in stainless steel and in high resistance copper, bronze and brass alloys is exclusively to be considered in applications characterized by environmental corrosion phenomena, such as burial in aggressive soils, corrosion from atmospheric pollution and marine environment.

In the latter cases, an adequate protective surface treatment, like galvanizing or epoxy painting, can be many times sufficient to limit the particular phenomena of environmental corrosion over time.

For the choice of materials, it is suggested to refer to the various international standards in force which include classification, testing and packaging.

When choosing the thread, it is preferable to use coarse-pitch bolts, since it guarantees better resistance to stripping of the threads compared to the equivalent bolts with fine-pitch threading.

It is also recommended to use the general specifications for the choice of bolts and tie rods when selecting the clamping nuts.

Normalized flanges

To facilitate the interchangeability of equipment and line accessories with flanged ends and to avoid sizing calculations during the design phase, all the flanges currently used in the construction of thermoplastic pipes are produced in accordance with specific international standards for unification.

The international unification standards for the construction of flanges for thermoplastic pipes, take their cue from the equivalent standards for metal pipes, specify the dimensions of the coupling elements of a flange, and expressly:

- the drilling distance (or diameter of the drilling circle);
- the number and diameter of the bolts and bolt holes;
- the external diameter and thickness of the flange.

The dimensions of the coupling elements, simply called the drilling template, are unified according to the nominal pressure PN of the flange and a conventional coupling diameter, simply called nominal diameter DN.

To check the compatibility between the different drilling templates prescribed by the unification standards, it is advisable to consult the following table, which illustrates the main coupling dimensions of the flanged joints according to DIN 2501, with drilling PN10/16 up to DN 150 and PN10 from DN200.

Backing rings dimensions according to DIN 2501, with drilling PN10/16 up to DN150 and PN10 from DN200

De (mm)	DN	Pitch diameter (mm)	Hole diameter (mm)	Number of bolts
20	15	65	14	4
25	20	75	14	4
32	25	85	14	4
50	32	100	18	4
50	40	110	18	4
63	50	125	18	4
75	65	145	18	4
90	80	160	18	8
110	100	180	18	8
125	125	210	18	8
140	125	210	18	8
160	150	240	22	8
200	200	295	22	8
225	200	295	22	8
250	250	350	22	12
280	250	350	22	12
315	300	400	22	12
355	350	460	22	16
400	400	515	25	16

For further information on our complete flange portfolio and different drilling standards and sizing available please refers to our Aliaxis system catalogues.

Installation Instructions

To guarantee the correct installation of flanged elements, we recommend to perform the following operations:

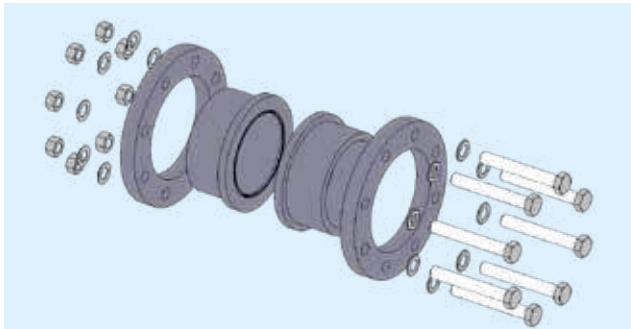

- 1) Insert the possible backing ring onto the pipe, before proceeding with the installation of the stub.
- 2) In the event of a fixed flange, check the drilling is correctly aligned with the counter flange.
- 3) Check that the position of the counter flange takes into account the overall dimensions of the face to face distance of the components.

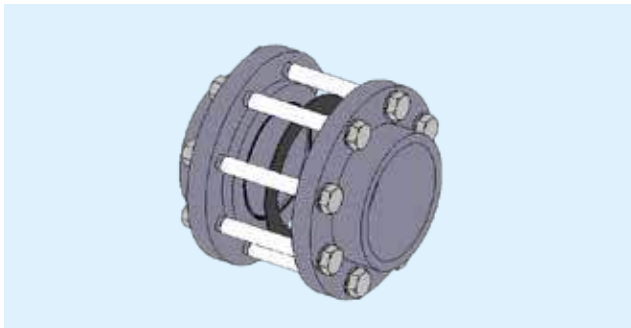

- 4) Insert the flat gasket between the stubs (this step is not necessary for FIP and Astore butterfly valves), making sure the sealing surfaces of the flanges have not been separated by an excessive distance.

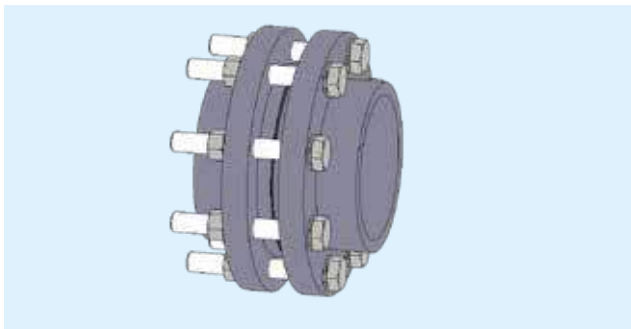

- 5) Proceed with solvent welding, or welding of the fixed flanges or stub in the case of backing rings, following the welding or solvent welding instructions.
- 6) Insert all the bolts, washers and nuts.

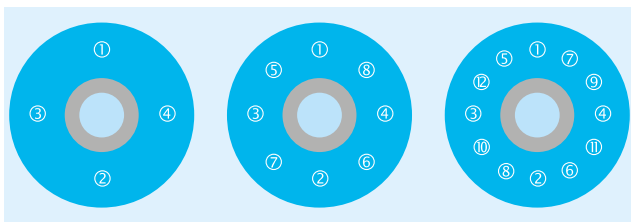

- 7) Once the cooling time is up, proceed with tightening the bolts in a "cross-wise" order, as described in the picture according to 4, 8 or 12 bolt flange.
- 8) Complete the bolt tightening process using a torque wrench until the right tightening torque value is reached.

In next table values of tightening torque are represented for nuts and bolts to achieve the seal with flanges in CPVC and UPVC with gaskets in EPDM/FPM/NBR.

Tightening torque for CPVC and UPVC backing rings

De (mm)	DN	Torque value (Nm)
20	15	9
25	20	9
32	25	9
40	32	9
50	40	9
63	50	12
75	65	15
90	80	18
110	100	20
125	125	35
140	125	55
160	150	40
200	200	55
225	200	55
250	250	70
280	250	70
315	300	70
355	350	75
400	400	75

Tolerance on torque is +/-10%.

Tightening torques for flange bolts in ABS piping system are listed in this table.

Tightening torque for ABS backing rings

De (mm)	DN	Torque value (Nm)
16	10	15
20	15	15
25	20	15
32	25	15
40	32	20
50	40	30
63	50	35
75	65	40
90	80	40
110	100	40
140	125	50
160	150	60
225	200	70
250	250	80
315	300	100

Tolerance on torque is +/-10%.

In the next tables values of tightening torque are listed to achieve the seal with PP flanges with stainless steel core.

Tightening torque for PP-St backing rings and blind flanges

De (mm)	DN	Torque value for backing rings (Nm)	Torque value for blind flanges (Nm)
20	15	15	15
25	20	15	15
32	25	15	15
40	32	20	25
50	40	30	35
63	50	35	35
75	65	40	40
90	80	40	40
110	100	40	45
125	100	40	45
140	125	50	50
160	150	60	60
180	150	60	60
200	200	70	70
225	200	70	70
250	250	80	100
280	250	80	100
315	300	100	110
355	350	120	160
400	400	140	170

In the next table are reported the minimum lengths of bolts for flanged connections of FIP butterfly valves.

Bolts minimum length for flanged connections of FIP butterfly valves

De (mm)	DN	L _{min} (mm)
50	40	M 16x150
63	50	M 16x150
75	65	M 16x170
90	80	M 16x180
110	100	M 16x180
125/140	125	M 16x210
160/180	150	M 20x240
200/225	200	M 20x260
250/280	250	M 20x310
315	300	M 20x340
355	350	M 20x360
400	400	M 24x420

In the table below are reported the minimum lengths of bolts for flanged joints of pipes.

Bolts minimum length for flanged joints of pipes.

De (mm)	DN	L _{min} (mm)
20	15	M 12x70
25	20	M 12x70
32	25	M 12x70
40	32	M 16x85
50	40	M 16x85
63	50	M 16x95
75	65	M 16x95
90	80	M 16x105
110	100	M 16x105
125	125	M 16x115
140	125	M 16x120
160	150	M 20x135
200	200	M 20x140
225	200	M 20x140
250	250	M 20x150
280	250	M 20x160
315	300	M 20x180
355	350	M 20x180
400	400	M 22x180

Please note that:

- the use of flanges in coated metal or fibreglass may allow the application of higher tightening torques, provided these do not exceed the elastoplastic limit of the material;
- the use of different elastomeric seal materials from those listed in the previous table may require slightly higher tightening torques;
- Aliaxis always recommends the use of suitably sized washers for any bolt used in the coupling flange.



WARNING

In our butterfly valves the liner seat extends around to both faces of the valve. As a result, no gaskets are required due to the seat serve the function of them. Moreover, using flat gaskets in butterfly valves may create tightness problems because of rubber to rubber contact.

Advantages and applications

Flanges joints are used in fire protection pipelines, or in gas, water and industrial process systems. They are used because they can provide a leak-proof disconnection point and allow inserting metering and regulating devices in pumping. They are easily removable, economical and, as described before, give possibility to join two pipes of different size together.

3.1.7 Threaded Joints

By definition, the threaded joint is that longitudinal connection system that allows the connection of two complementary elements (male and female) through a helical movement of the same.

The joining of thermoplastic pipes and fittings through threaded ends is widely used in civil and industrial systems where there is a need to connect non-homogeneous equipment and accessories.

The application on homogeneous thermoplastic lines is instead preferred when the piping network must be disassembled for occasional cleaning or modification operations.

Since the thread reduces the effective wall thickness, the threaded pipes are characterized by a lower mechanical resistance compared to the non-threaded ones and those that can be joined by thermal welding or by solvent.

Requiring a particular rigidity of the material, the thread is recommended only for particular thermoplastic resins: for example it is widely used in homogeneous rigid PVC pipes, since it associates undoubted installation advantages, such as the possibility of immediate operation, quick disconnection of connections and a wide range of accessories and fittings for the construction of even complex lines

It is also used in C-PVC and ABS, while it is not recommended for PP and PE pipes unless appropriate additions of fillers in the mix, like fiberglass, which increase rigidity and mechanical resistance.

In the production of rigid PVC pipes and fittings, BSP threads (British Standard Pipe) or NPT threads (National Pipe Thread) are used.

The main characteristics are the following ones:

1) BSP thread: has been adopted internationally for interconnecting and sealing pipes and fittings by mating an external (male) thread with an internal (female) thread. It has been adopted as standard in plumbing and pipe fitting, except in North America, where NPT and related threads are used.

Two types of threads are distinguished:

- British Standard Pipe Parallel thread (BSPP), which have a constant diameter; denoted by the letter G. Female and Male threads are both parallel. BSPP thread used where a pressure-tight joint is achieved by the compression of soft material (such as an o-ring seal or a washer) between the end face of the male thread and a socket face, with the tightening of a backnut;
- British Standard Pipe Taper thread (BSPT), whose diameter increases or decreases along the length of the thread; denoted by the letter R. BSPT thread is used where pressure-tightness is made through the mating of two threads together. International standards require all female thread is parallel and male thread is tapered.

Before looking at the BSPP thread configuration in detail and comparing it to an NPT, it may be useful to define the main elements of a thread:

- major diameter: the outer diameter;
- minor diameter: the internal diameter;
- crest: prominent part of a thread;
- thickness of thread: distance between the adjacent sides of the thread measured along or parallel to the pitch line;
- helix angle: angle between any helix and an axial line on its right;
- pitch: the distance between adjoining threads;
- form: the profile or shape of a thread;
- root: bottom of the groove between the two flanking surfaces;
- flank: straight sides that connect the crest and the root.

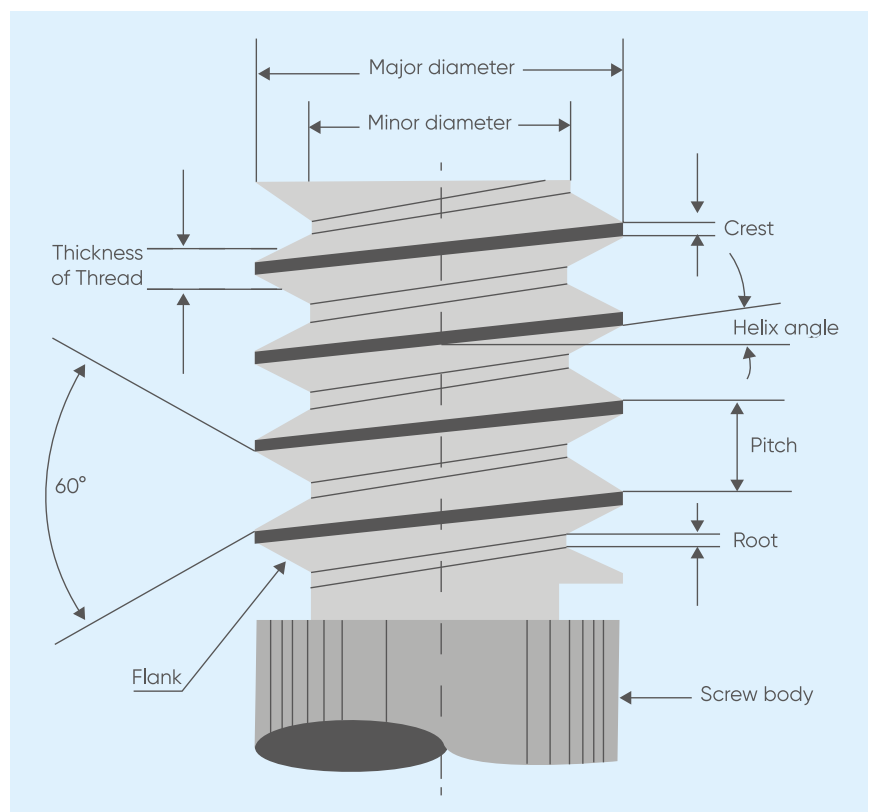

In these two images a BSPP thread configuration is represented.

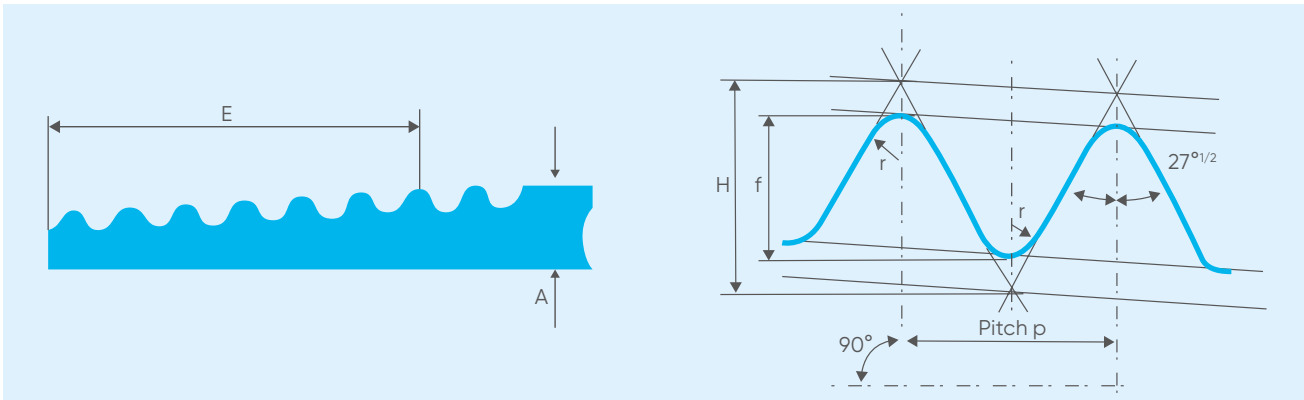

The standard ISO 228 - 1 contains main dimensions for pipe threads where pressure-tight joints are not made on the threads, that are listed in the following table.

DN (in)	Number of threads in 25.4 mm	Pitch (mm)	Height of thread (mm)	Effective threads length (mm)
	n	p	h	E
1/4"	19	1.337	0.856	9.688
3/8"	19	1.337	0.856	10.025
1/2"	14	1.814	1.162	13.152
3/4"	14	1.814	1.162	14.514
1"	11	2.309	1.479	16.714
1 1/4"	11	2.309	1.479	19.050
1 1/2"	11	2.309	1.479	19.050
2	11	2.309	1.479	23.378
2 1/2"	11	2.309	1.479	26.698
3	11	2.309	1.479	29.873
4	11	2.309	1.479	35.791

The standard ISO 7 - 1 contains main dimensions for pipe threads where pressure-tight joints are made on the threads, that are listed in the following table.

DN (in)	Number of threads in 25.4 mm	Pitch (mm)	Height of thread (mm)	Effective threads length (mm)
	n	p	h	E
1/4"	19	1.337	0.856	9.7
3/8"	19	1.337	0.856	10.1
1/2"	14	1.814	1.162	13.2
3/4"	14	1.814	1.162	14.5
1"	11	2.309	1.479	16.8
1 1/4"	11	2.309	1.479	19.1
1 1/2"	11	2.309	1.479	19.1
2	11	2.309	1.479	23.4
2 1/2"	11	2.309	1.479	26.7
3	11	2.309	1.479	29.8
4	11	2.309	1.4789	35.8

2) NPT thread: it corresponds to the American national technical standards for screw threads, and it is particularly used in the construction of pipelines for the transport of pressurized fluids in the chemical and petrochemical industry.

The following two pictures show a cylindrical NPT thread configuration.

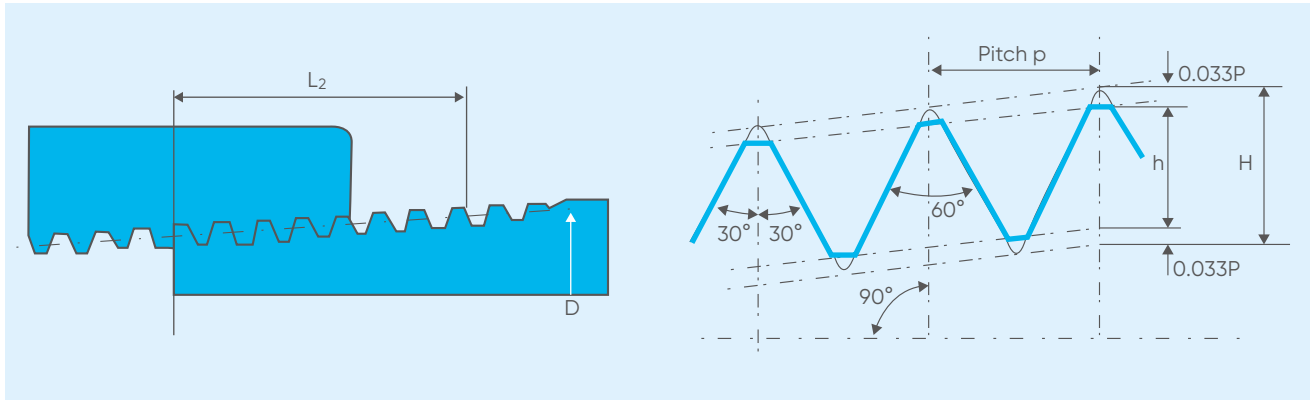

Defined for water tightness in the threads, the NPT thread is used for tapered screw and sleeve couplings, whose dimensions and characteristics are illustrated in the ANSI B1.20.1 standards and subsequent amendments.

Main dimensions are listed in the table.

DN (in)	Number of threads in 25.4 mm	Pitch (mm)	Height of thread (mm)	Effective threads length (mm)
	n	p	h	E
1/4"	18	1.4112	1.1288	10.2057
3/8"	18	1.4112	1.1288	10.3581
1/2"	14	1.8143	1.4514	13.556
3/4"	14	1.8143	1.4514	13.8608
1"	11.5	2.2088	1.7671	17.3431
1 1/4"	11.5	2.2088	1.7671	17.9527
1 1/2"	11.5	2.2088	1.7671	18.3769
2	11.5	2.2088	1.7671	19.2151
2 1/2"	8	3.175	2.54	28.8925
3	8	3.175	2.54	30.48
4	8	3.175	2.54	33.02

Installation instructions

To guarantee the hydraulic seal of the joint on fittings and valves with a threaded female end, Aliaxis recommend you perform the following operations:



1) Start winding some PTFE sealing tape on the outside of the threaded male end, taking care not to obstruct the through-hole on the pipe, fitting or valve



2) Complete the first winding layer by winding the tape clockwise until you reach the root of the thread. Remember to keep the tape taut throughout the entire process.



3) Press on the tips of the thread to make sure the tape adheres fully to the support clip.

4) Increase the thickness of the PTFE layer by continuing to apply the taut tape and winding it clockwise until you achieve the optimal level.

6) Make sure the layer of PTFE is not removed during screwing, as this would compromise the hydraulic seal of the joint.

7) Complete screwing the two ends exploiting the entire length of the thread with the aid of a strap wrench or similar tool.

8) Avoid tightening the elements too much, as this could damage the threads or cause stress to the elements themselves.

For correct installation, Aliaxis recommends to only use sealing tape in non-sintered PTFE.

Under all circumstances avoid using materials such as hemp, lint or paints usually implemented for the hydraulic seal on metal threads.



WARNINGS

Avoid using threaded joints in the following cases:

- highly critical applications, such as for conveying chemically aggressive or toxic fluids;
- in the presence of medium or high pressures: in this case, Aliaxis recommend the use of solvent welding joints, hot welding joints or flanged joints;
- systems subject to mechanical and/or thermal stresses such as water hammers, strong variations in temperature, bends, misalignments and cross tensions which could cause the threaded joint to break prematurely;
- coupling of elements with excessive distance from one another.

Advantages and applications

Threaded joints are used in water and gas pipelines. They offer a high load-carrying capacity and reliability. Inspection, repair or replacement of threaded assembly are not expensive but easy, because they can be dismantled when required.

3.1.8 Mechanical Jointing of pipelines with Straub coupling

There are numerous possibilities for connecting pipes that require a lot of special knowledge paired with keeping extensive stock. Straub couplings were invented more than 50 years ago in order to sort out this "clutter". The basic idea of the Straub pipe connection is to connect plain pipe ends without any need to treat neither the pipe ends nor the coupling.

The quick, easy and reliable Straubing took the place of welding or flange connections. Thanks to its ingenious concept, the original STRAUB coupling is regarded as one of the groundbreaking innovations in the global market of pipe connection technology.

Two distinctions can be noticeable in the STRAUB range: GRIP couplings are axially restraint, while FLEX couplings are axially non-restraint.

The dynamic STRAUB-GRIP anchoring system is able to absorb the axial forces arising from the internal pressure, by special anchoring rings engaging in the relevant pipe material and providing a mechanical connection. If the axial tensile load on the pipe increases due to increasing internal pressure, the anchoring ring engages deeper into the pipe surface.



While the standard application for STRAUB-GRIP couplings is to connect metal pipes of nearly any kind, there are two different solutions for the use with plastic pipes: STRAUB-COMBI-GRIP which is used for transitions from metal to plastic pipes and STRAUB-PLAST-GRIP for the connection of plastic pipes.

The installation and connection of plastic pipes presents new challenges for the contractor. Many connection types are dependent on the weather or temperature or need electrical equipment and special tools for the installation, or special knowledge and approvals. Pipes made of all types of plastic can be easily connected with STRAUB-PLAST-GRIP. In particular, two different plastics can be connected to each other.

In the case of adjustments to or changes of already installed systems, the pipe connection can be easily detached and re-used. The costs/benefits ratio is positively influenced.

STRAUB-COMBI-GRIP and STRAUB-PLAST-GRIP are axial restraint reliable pipe connections that can be used everywhere at any time. Both couplings are available in the diameter ranges from 38 mm up to 355 mm and can be used in the temperature ranges from -20°C till +100°C with EPDM gasket, and from -20°C till +80°C with NBR gasket.



One more variety in the axially restrained pipe couplings is called STRAUB-PLAST-PRO which is used mainly for the installation of pressure pipes made of polyethylene (PE). STRAUB-PLAST-PRO offers an alternative to traditional jointing methods of PE used in water, wastewater, industrial plants and maintenance applications. The complete product range is available for PE pipes in dimension SDR 11 (63.0 - 180.0 mm; PN 16) and SDR 17 (125.0 - 355.0 mm; PN 10).

The full product range offers the great advantage that pipes can easily be connected without the need of external power supply and pipe end preparation, even under demanding external weather conditions.

The pipes made of PE 80 or PE 100 are connected with a combination of liner inserts and external shells. The jointing concept allows the product to be assembled easily and in very short time.

PE pipes with added protective layers are available in a variety of designs such as PE pipes with a diffusion proof aluminium foil barrier layer that are commonly preferred to be laid in contaminated soil sites. Thus, pollutants are prevented from entering into the pipe and the medium is prevented from getting into ground soil.

STRAUB-PLAST-PRO also connects barrier layer pipes easily and safely without any pipe end preparation. Before assembly the pipe outside diameter should be confirmed and checked that it fits into the working range of the individual shell. The temperature working range covers -5°C till $+40^{\circ}\text{C}$.

STRAUB-PLAST-PRO has been successfully tested according to the British Standard WIS 4-24-01 and fulfil the requirements of European standard EN 1254-3.



STRAUB-FLEX pipe couplings enable pipe connections for practically all conceivable pipe diameters, for the same or different types of pipe materials, various media and temperatures as well as for a wide range of the operating pressure values.

As STRAUB-FLEX pipe couplings cannot axially absorb any forces, the pipes must be secured axially using appropriate measures on-site such as tie rods, fixed and sliding points, concrete abutments etc. The sealing sleeve separates the coupling casing from the pipe surface so that sound, vibrations and oscillations are optimally damped.

STRAUB-FLEX couplings are available in the diameter ranges from 48.3 mm up to 4064 mm and can be used in the temperature ranges from -20°C till $+180^{\circ}\text{C}$. The sealing sleeves of these couplings are made of EPDM, NBR, or FKM.



STRAUB-OPEN-FLEX on the other hand, are the pipe couplings have the same characteristics as STRAUB-FLEX couplings but expand their possible uses. The casings of the STRAUB-OPEN-FLEX product series can be hinged or available as 2-part or 3-part version. As a result, STRAUB-OPEN-FLEX couplings can be used for connecting pipes or repairs without removal of existing pipes.

STRAUB-OPEN-FLEX couplings are available in the diameter ranges from 48.3 mm up to 4064 mm and can be used in the temperature ranges from -20°C till $+180^{\circ}\text{C}$. The sealing sleeves of these couplings are made of EPDM, NBR, or FKM.



There is also a possibility that while pipe installation requires connection of pipes having different external diameters. Our solution for the above-mentioned scenario is called STRAUB-STEP-FLEX.

The possible diameter differences of the pipes to be connected can be 10 mm up to max. 30 mm. Larger diameter differences can be achieved using the integration of a reduction fitting piece with two couplings. Smaller diameter differences (5 - 9 mm) can be bridged on request using STRAUB-FLEX 2 / 3.

Under pressure, STRAUB-STEP-FLEX pipe couplings, due to the diameter differences, are always pushed by internal forces in the direction of the smaller pipe diameter and must therefore be secured against slipping using appropriate measures.

Thrust rings are available on request; retainers are not necessary for non-pressurized applications.

STRAUB-STEP-FLEX couplings are available in the outside diameter ranges from 219.1 mm up to 2032 mm and can be used in the temperature ranges from -20°C till $+100^{\circ}\text{C}$. The sealing sleeves of these couplings are made of EPDM. The diameter differences between the pipes to connect up to 30 mm is possible.



Strip Inserts

The safe connection of STRAUB coupling is ensured by the uniqueness and advanced features of its accessories. Strip inserts are used to protect the sealing sleeve against mechanical or chemical damage in the pipe end area. Strip inserts are required for:

- excessive distance between pipe ends;
- axial movement (expansion, contraction);
- angular deflection and axial misalignment;
- vacuum (e.g. suction line);
- external pressure (e.g. underwater pipeline);
- high temperature;
- fuel and combustibles;
- swelling of the rubber caused by contact with chemicals.

The material selection is determined by the medium and the temperature. At environmental temperatures, with saltwater and chemicals, strip inserts in plastic are used. Stainless steel strip inserts are required for higher temperatures, vacuum and external pressure. Combinations of plastic and stainless steel are also possible. T-profile strip inserts ensure the installation position where there are strong and dynamic loads.

Strip inserts made of PVDF can be used in the temperature ranges -30°C up to 115°C , whereas HDPE strip inserts are suitable in the temperature ranges -50°C up to 70°C .

The tables below could be useful in choosing the appropriate strip insert depends on the coupling.

STRAUB pipe coupling	Stainless steel		Plastic		Plastic-T-Profile *	
	AISI 316 L or similar	AISI 301	PVDF	HDPE	PVDF	HDPE
STRAUB-METAL-GRIP			x			
STRAUB-GRIP 25.0-168.3 mm	x		x	x		
STRAUB-GRIP 180.0-711.2 mm	x					
STRAUB-ECO-GRIP	x					
STRAUB-PLAST / COMBI-GRIP	x		x			
STRAUB-FLEX / OPEN-FLEX 1	x		x		x (from 76.1 mm)*	
STRAUB-FLEX / OPEN-FLEX 2	x			x		x *
STRAUB-FLEX / OPEN-FLEX 3	x			x		x *
STRAUB-FLEX / OPEN-FLEX 3.5		x		x		
STRAUB-FLEX / OPEN-FLEX 4		x		x		

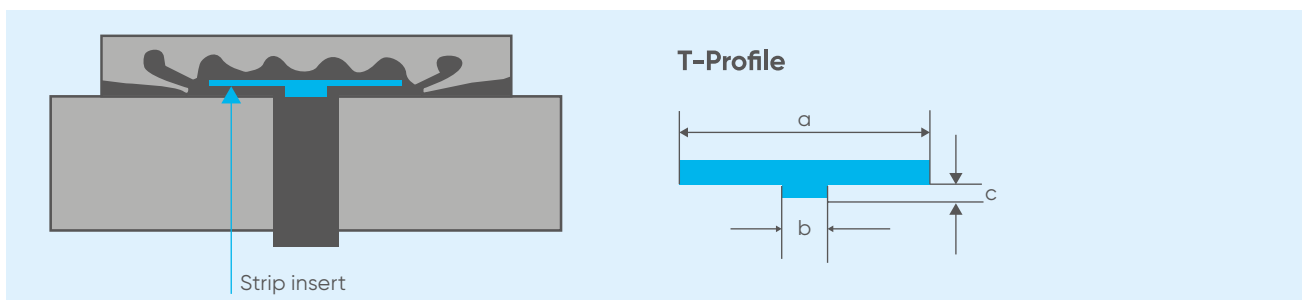

* The characteristics of Plastic-T-Profile for OPEN-FLEX 1, OPEN-FLEX 2, OPEN-FLEX 3 are listed in the next table.

Plastic-T-Profile	De	Strip width a (mm)	Cam width b (mm)	Cam height c (mm)
STRAUB-FLEX / OPEN-FLEX 1	76.1 - 118.0 mm	45	5	3.5
	127.0-168.3 mm	55	5	3.5
STRAUB-FLEX / OPEN-FLEX 2	all De	75	7.5	6
STRAUB-FLEX / OPEN-FLEX 3	all De	118	10	6

Stiffening Rings

Thermoplastic pipes can be deformed under the influence of pressure and heat. Through the use of STRAUB stiffening rings, a constriction of the plastic pipe ends is prevented. STRAUB stiffening rings consist of stainless-steel DIN 14301/AISI 304 and are available in slotted (De 40 - 315mm) and welded designs (De 355 - 1600 mm). One of the following may be required:

- inside diameter;
- SDR number;
- wall thickness of the plastic pipe

If the pipes already exhibit constriction due to long storage, we recommend cutting off these constricted sections before fitting the STRAUB stiffening rings. Slotted stiffening rings must be fitted in the direction of the arrow marked and installed flush with the pipe end.

Note: For plastic pipes in PVC, ABS and CPVC, and with fiberglass pipes, no stiffening rings are required for media temperatures under 40°C.



The table below which is valid only for soft thermoplastic pipes for example PP, PE, etc. can be useful in choosing the stiffening ring for STRAUB-PLAST-GRIP coupling.

SDR	41	33/32.25	26	17.6	17	11	7.4/7.25
Serie-Nr.	S 20	S 16/S 15.625	S 12.5	S 8.3	S 8	S 5	S 3.2/S 3.125
Norm	DIN 8074	DIN 8074	DIN 8074	DIN 8074	DIN 8074	DIN 8074	DIN 8074
Pipe De	Pipe Di	Pipe Di	Pipe Di	Pipe Di	Pipe Di	Pipe Di	Pipe Di
De (mm)	(mm)	(mm)	(mm)	(mm)	(mm)	(mm)	(mm)
40	-	-	36.4	35.4	35.2	32.6	29
50	-	46.4	46.0	44.2	44.0	40.8	36.2
63	59.4	59.0	58.0	55.8	55.4	51.4	45.8
75	71.2	70.4	69.2	66.4	66.0	61.4	54.4
90	85.6	84.4	83.0	79.8	79.2	73.6	65.4
110	104.6	103.2	101.6	97.4	96.8	90.0	79.8
125	118.8	117.2	115.4	110.8	110.2	102.2	90.8
140	133.0	131.4	129.2	124.0	123.4	114.6	101.6
160	152.0	150.2	147.6	141.8	141.0	130.8	116.2
180	171.2	169.0	166.2	159.6	158.6	147.2	130.8
200	190.2	187.6	184.6	177.2	176.2	163.6	145.2
225	214.0	211.2	207.8	199.4	198.2	184.0	163.4
250	237.6	234.6	230.8	221.6	220.4	204.6	181.6
280	266.2	262.8	258.6	248.2	246.8	229.2	203.4
315	299.6	295.6	290.8	279.2	277.6	257.8	228.8

Choosing stiffening rings owing to measurements on pipes only conditionally possible

Valid only to soft thermoplastic pipes f.e. PE, PP, etc.

Stiffening rings are optional accessories and must be ordered separately.

Installation instructions

1) A space between pipe ends can arise through misalignment, ground movement, inaccurate assembly or changes in length. STRAUB couplings can bridge spaces between pipe ends.

- 5 - 10 mm without strip insert (depending on pipe De, please observe the coupling label)
- 5 - 35 mm with strip insert (depending on pipe De, please observe technical data sheet)

Strip inserts are used in case of: large distance between pipe ends, swelling due to aggressive liquids, vacuum, under outside pressure, high temperature. Strip inserts are extras and must be ordered separately.

Do not exceed the listed pipe gap; further information refer the table below.

De (mm)	α in degrees						
	1	2	4	6	8	10	12
	Rmax (mm)			Rmax (mm)			
26.9	0.5	1	2	3	4	5	6
30.0	0.5	1	2	3	4	5	6
33.7	0.5	1	2	3	4	6	7
38.0	1	1	3	4	5	7	8
40.0	1	2	3	4	6	7	8
42.4	1	2	3	4	6	7	9
44.5	1	2	3	5	6	8	9
48.3	1	2	3	5	7	8	10
50.0	1	2	4	5	7	9	11
54.0	1	2	4	6	8	9	11
57.0	1	2	4	6	8	10	12
60.3	1	2	4	6	8	11	13
63.0	1	2	4	7	9	11	13
75.0	1	3	5	8	11	13	16
76.1	1	3	5	8	11	13	16
84.0	2	3	6	9	12	15	18
88.9	2	3	6	9	12	16	19
90.0	2	3	6	9	13	16	19
104.0	2	4	7	11	15	18	22
108.0	2	4	8	11	15	19	23
110.0	2	4	8	12	15	19	23
114.3	2	2	8	12	16	20	24
125.0	2	2	9	13	17	22	26
129.0	2	5	9	14	18	23	27
133.0	2	5	9	14	19	23	28
139.7	2	5	10	15	20	24	29
140.0	2	5	10	15	20	24	29
154.0	3	5	11	16	22	27	32
159.0	3	6	11	17	22	28	33
160.0	3	6	11	17	22	28	33
168.3	3	6	12	18	24	30	35

De (mm)	α in degrees					
	1	2	3	4	6	8
	Rmax (mm)			Rmax (mm)		
180.0	3	6	9	13	19	25
200.0	4	7	11	14	21	28
219.1	4	8	12	15	23	31
244.5	4	9	13	17	26	34
250.0	4	9	13	17	26	35
267.0	5	9	14	19	28	37
273.0	5	10	14	19	29	38
304.0	5	11	16	21	32	42
323.9	6	11	17	23	34	45
355.6	6	12	19	25	37	50
406.4	7	14	21	28	43	57
457.2	8	16	24	32	48	
508.0	9	18	27	36	53	-
559.0	10	20	29	39	59	
575.0	10	20	30	40	-	-
609.6	11	21	32	43		
711.2	12	25	37	50	-	-
762.0	13	27	40	53		
812.8	14	28	43	57	-	-
914.4	16	32	48			
1016.0	18	36	53	-	-	-
1117.6	20	39	59			
1219.2	21	43	-		--	-
1320.8	23	46				
1422.4	25	50	-	-	-	-
1524.0	27	53				
1625.6	28	57	-	-	-	-
1727.2	30					
1828.8	32	-	-	-	-	-
1930.4	34					
2032.0	36	-	-	-	-	-

Gaps between pipe ends are created by angular deflection, inaccurate assembly and changes in length. This gap must not exceed the value R_p (R_p = pipe end gap / may be obtained from product datasheet). Using a strip insert, the pipe and gap can be enlarged. This maximum value depends on the design of each coupling type and may be obtained from the relevant product datasheet.

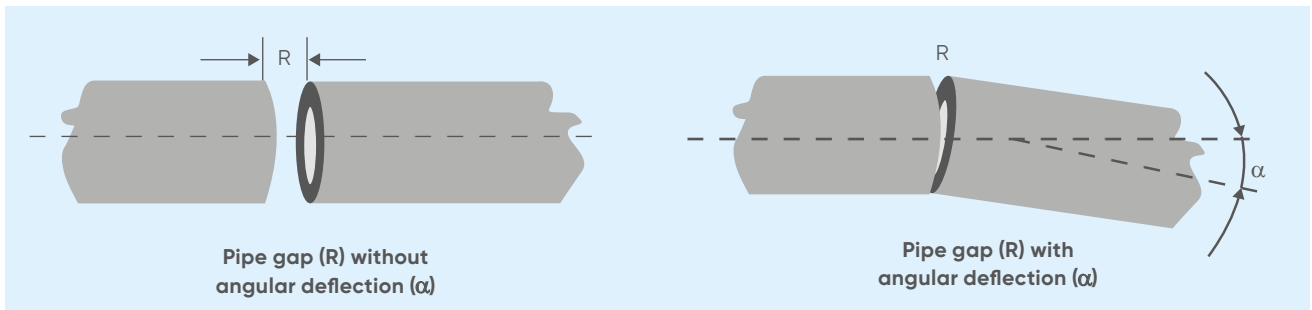

2) STRAUB couplings to connect two pipes with all around angular deflection to the pipe axis:

- $< \varnothing 60.3 \text{ mm}$ ----->>> 5°
- $> \varnothing 76.1 \text{ mm}$ ----->>> 4°
- $> \varnothing 219.1 \text{ mm}$ ----->>> 2°
- $> \varnothing 609.6 \text{ mm}$ ----->>> 1°

See distance between pipe ends [R^p]

3) STRAUB pipe couplings allow a low axial misalignment:

- 1% of outside diameter (max. 3 mm)

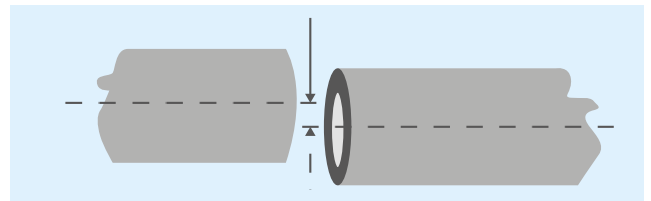

4) STRAUB couplings compensate pipes with different outside diameters.

The following requirements must be satisfied:

- $< \varnothing 100 \text{ mm}$ ----->>> 2 mm
- $> \varnothing 100 \text{ mm}$ ----->>> 2% of D_e
- $> \varnothing 300 \text{ mm}$ ----->>> 6 mm
- D_e -difference up to 9 mm ----->>> STRAUB-FLEX
- D_e -difference from 10 mm ----->>> STRAUB-STEP-FLEX

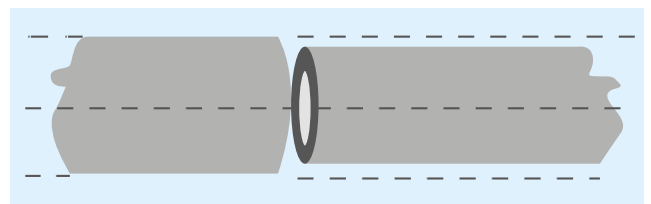

5) Pipes often show an out-of-roundness (difference between the biggest and the smallest outside diameter). The reliable out of roundness is:

- STRAUB-FLEX 1 ----->>> 4 mm
- STRAUB-FLEX 2 ----->>> 2% of \varnothing
- STRAUB-FLEX 3 ----->>> 2% of \varnothing
- STRAUB-FLEX 3.5 ----->>> 2% of \varnothing
- STRAUB-FLEX 4 ----->>> 2% of \varnothing

STRAUB-FLEX 2: to provide over-slide possibility, out-of-roundness [X] has also to be within the admissible difference in diameters ($X = \text{max. } 6 \text{ mm}$).

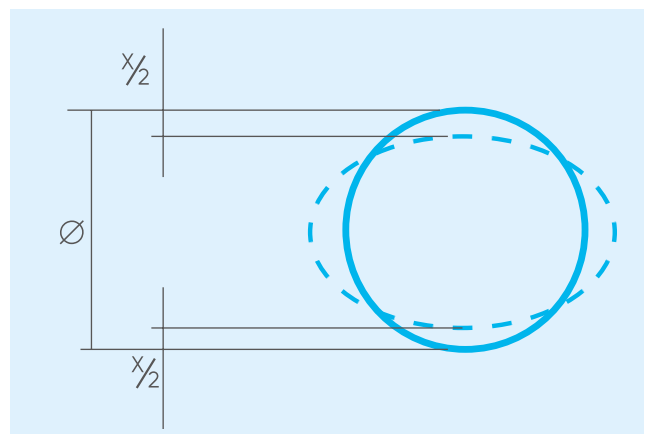

6) The PN internal pressure acts directly as tensile force on every pipe connection. The prevailing tensile force can be calculated from the respective internal pressure and the known pipe diameter. It cannot be absorbed by STRAUB-FLEX and STRAUB-OPEN-FLEX.

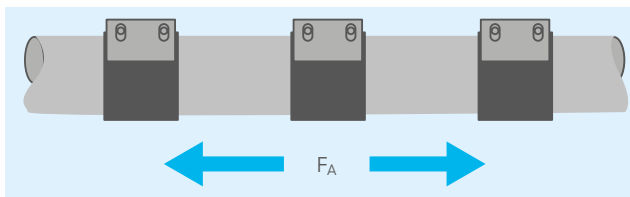

7) If the pipes are obstructed in their axial movement, the pipe has the tendency to buckle in the case of increasing internal pressure in combination with inadequate pipe routing. It cannot be absorbed by STRAUB-FLEX and STRAUB-GRIP.

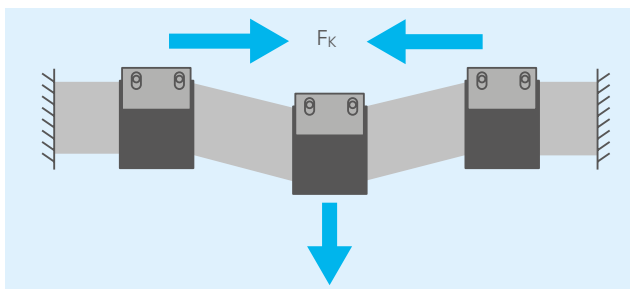

8) This consists of the weight of the pipe section and the weight of the medium contained in it. Pipe couplings can only absorb very small shear forces. It can only be absorbed to a limited extent by STRAUB-FLEX and STRAUB-GRIP.

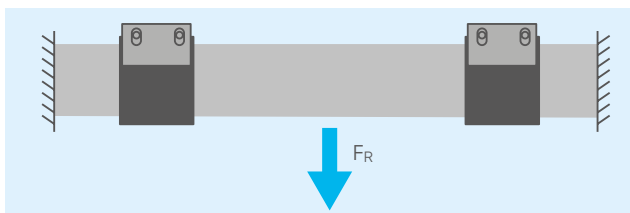

9) Pipes are exposed to temperature fluctuations whether from the medium (e.g. cold and warm water) or the environment (e.g. sunlight, cold in winter). These temperature fluctuations cause axial movements in the pipe.

The axial movement depends on the pipe material, the length of the respective pipe section and the temperature fluctuation.

When using STRAUB-GRIP pipe couplings, the pipe fastenings are selected so that the axial movement is transformed to angular deflection.

If STRAUB-FLEX pipe couplings are used, it must be ensured that the occurring axial change in each pipe section is not greater than the compensation capability of the used STRAUB-FLEX pipe coupling.

The table shows the values for maximum permissible axial length changes for STRAUB-FLEX and STRAUB-OPEN-FLEX.

STRAUB-FLEX STRAUB-OPEN-FLEX	Δl (mm)
1	5
2	10
3	15
3.5	15
4	20

10) Pipe fastening using STRAUB-GRIP:

- the pipes are anchored in the coupling;
- only mounts / supports are necessary;
- axial movements of the pipes must be compensated for outside the coupling, e.g. with expansion arches (refer the picture given below)

Pipe fastening using STRAUB-FLEX:

- the pipes are not anchored in the coupling;
- every pipe section needs one fixed point and one or more pipe guides;
- axial movements of the pipes can be compensated for within the coupling

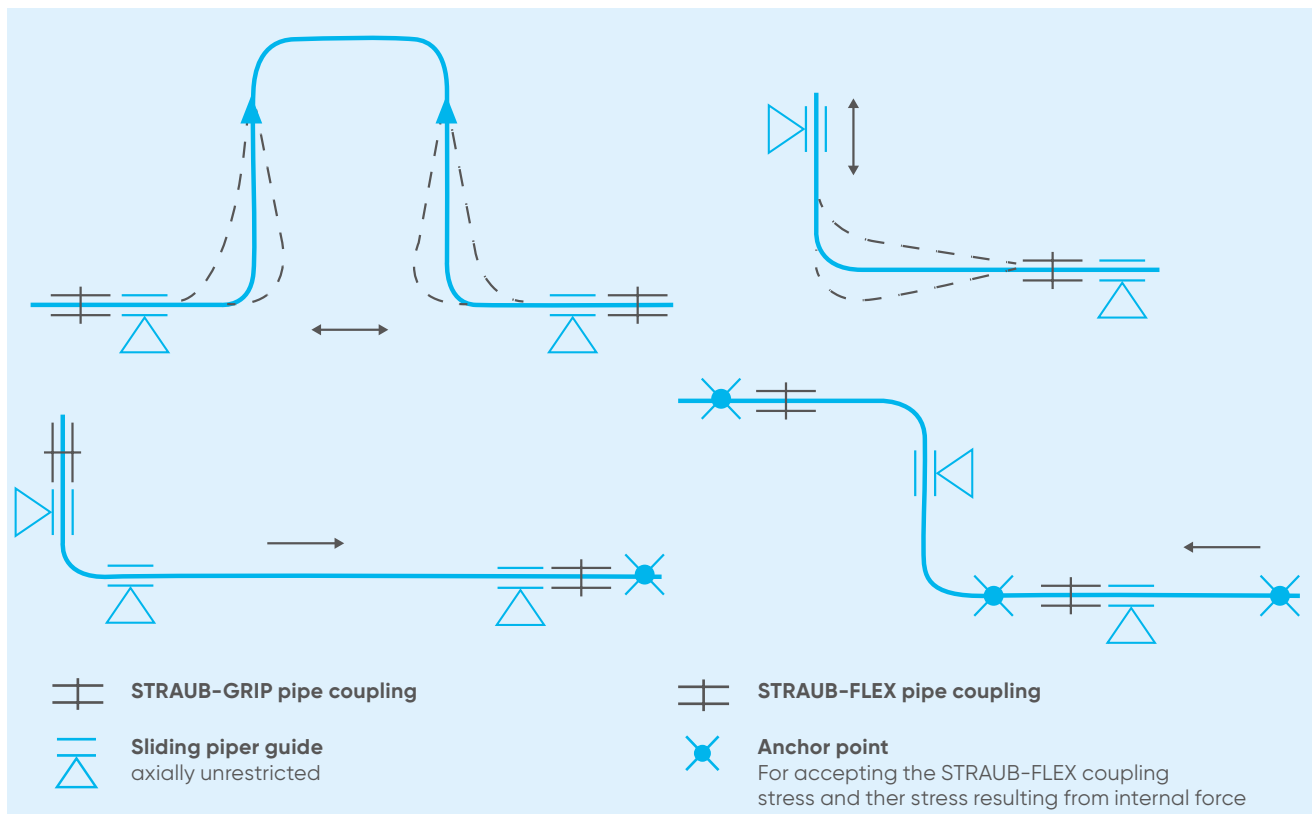
**WARNINGS**

While calculating the axial movement compensation, the thermal factors below should be considered.

- If the operating temperature is higher than the installation temperature, this results in elongation of the pipe.
In contrast, the pipe contracts if it is lower than the installation temperature.

Material specifications of STRAUB couplings

There are different material qualities available according to size, type, corrosion resistivity and pressure rating of the couplings. Basically, W1 is fully made of galvanized carbon steel, whereas W2 is made of stainless-steel casing and carbon steel bolts/bars. The other variety W4 is made of normal stainless-steel casing and high-quality stainless-steel bolts/bars, W5 is fully made of high-quality stainless steel.

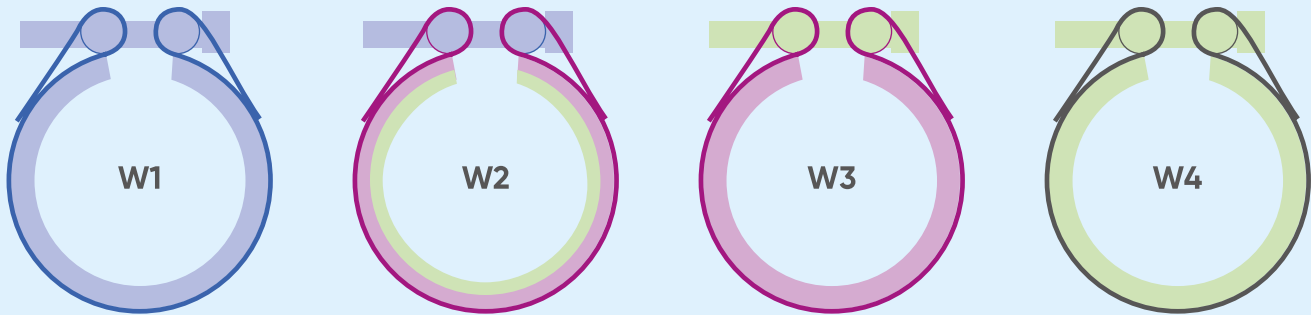

The table below could be useful in choosing the appropriate material based on the application.

Components	Materials							
	W1		W2		W4		W5	
	DIN	AISI	DIN	AISI	DIN	AISI	DIN	AISI
Casing	A738 or similar, hot-dip galvanised	1024	1.4404	316 L	1.4301	304	1.4404	316 L
			1.4301	304				
			1.4162	S32101			1.4162	S32101
Bolts	1.7220	4135	1.7220	4135	A4 - 80	A4 - 80	A4 - 80	A4 - 80
Bars	1.0737 galvanised	12L14	1.0737 galvanised	12L14	1.4404 1.4435	316 L	1.4404 1.4435	316 L
Anchoring ring	1.4310	301	1.4310 1.4301 (PLAST-GRIP)	301 304	1.4310 1.4301 (PLAST-GRIP)	301 304	1.4310	301
Strip inserts (option)	1.4435 PVDF/HDPE	316 L	1.4435 PVDF/HDPE	316 L	1.4435 PVDF/HDPE	316 L	1.4435 PVDF/HDPE	316 L

Advantages and applications

STRAUB couplings are compatible with almost any traditional jointing system. It is more reliable as it compensates axial movement and angular deflections. Moreover, it possesses pressure resistance capability and ensures a stress-free, flexible pipe joint. STRAUB couplings serve for many years as they are corrosion- and temperature resistant, also possess good resistance against chemicals. Since STRAUB coupling requires no special types of equipment or tools and set-up times, it is a more economical solution. It is the perfect solution where there is a need for a compact solution as STRAUB couplings are less in weight compared to flanges. Due to its great benefits, STRAUB couplings are mainly used in the application areas such as Water & Gas utilities, Groundwork & Industry, and Shipbuilding & Offshore.

3.2 Pipeline mounting and recommendations

3.2.1 Thermal expansion and contraction

When carrying out a project for a thermoplastic resin plant, it is always necessary to take into account any expansion and contraction due to temperature variations.

Thermal effects in plastics are different from metals: to illustrate the point, the figure below outlines the differences between different plastics and metal piping materials according to their coefficient of linear expansion.

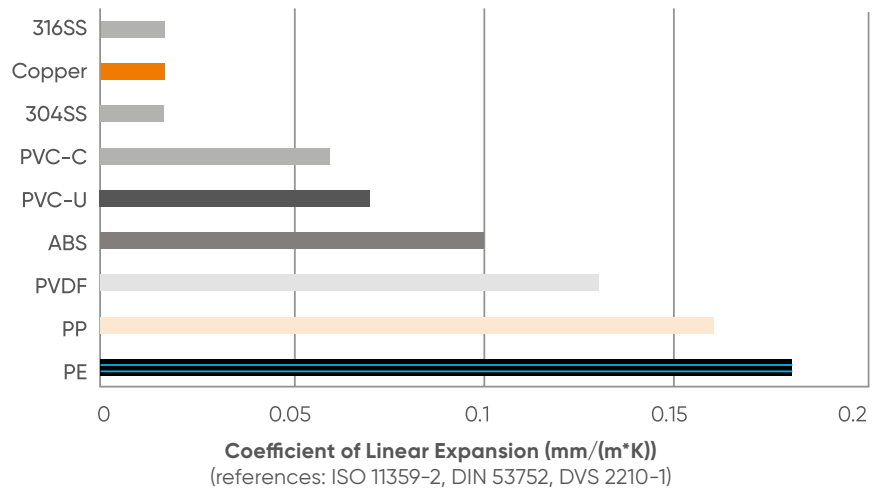

An increase in temperature in a system will cause the thermoplastic pipe to want to expand.

The problem is that if the system is locked in position and not allowed to expand, obviously the stress will increase and if it exceeds the allowable tolerated stress by the system, the piping will fatigue and eventually could fail.

In particular, progressive deformation may occur upon repeated thermal cycling or on prolonged exposure to elevated temperature in a restrained system.

Therefore thermoplastic systems require sufficient flexibility to prevent the expansion and contraction to avoid:

- failure of piping or supports from over strain or fatigue;
- leakage;
- detrimental stresses or distortion in piping or connected equipment.

Generally the expansion, or contraction, due to the birth of a thermal jump, can be easily evaluated by using the formula:

$$\Delta L = \alpha * L * \Delta T$$

where:

ΔL =value of the expansion or contraction (mm)

ΔT =temperature difference (°C)

L = length of the pipe (m)

α = coefficient of linear expansion or contraction (1/°C)

The values of the coefficient of expansion α for different materials are shown in the next table.

α	UPVC	CPVC	ABS	PP	PE HD	PVDF
(1/°C)	$0.8 * 10^{-4}$	$0.67 * 10^{-4}$	$1 * 10^{-4}$	$1.5 * 10^{-4}$	$2 * 10^{-4}$	$1.20 * 10^{-4}$

To calculate the parameters in the previous equation it is recommended to use the calculation tool on Aliaxis websites.

Generally, the compensation of thermal expansion is obtained by means of elements which, by exploiting or increasing the intrinsic elasticity of the lines, allow to limit the effects generated by the dimensional variations induced in the pipes.

A correct and economical selection of suitable thermal compensation systems leads to the use of the following elements:

- mechanical expansion joints;
- offset;
- expansion loops;
- direction changes.

Obviously, to determine the right employment of the three methods, the following data must be known and analysed:

- design, service and installation temperature conditions;
- type of material and size of the pipe;
- chemical and physical properties of the conveyed fluid;
- pipeline layout including all dimensions and all different thermal movements induced by not homogeneous materials employed for the construction of process plant equipment;
- movements and maximum end loads on the thermal points where the pipeline is connected to equipment with limited mechanical strength;
- design and service hydraulic conditions such as static and dynamic pressure.

3.2.1.1 Mechanical expansion joints

Expansion joints ensure effective absorption of displacements and dimensional variations in pipes subjected to repeated thermal cycles.

An example of expansion joints is shown in the next picture.

They are applied in installations where there is little space available and the excessive cost of the supporting and anchoring infrastructures makes it impossible to compensate for thermal expansion by means of additional pipe sections.

Expansion joints are chosen for their ability to absorb axial, transverse and rotational displacements of pipes subject to temperature variations. Two types of expansion joints are used for thermoplastic pipes: sliding and flexible joints.

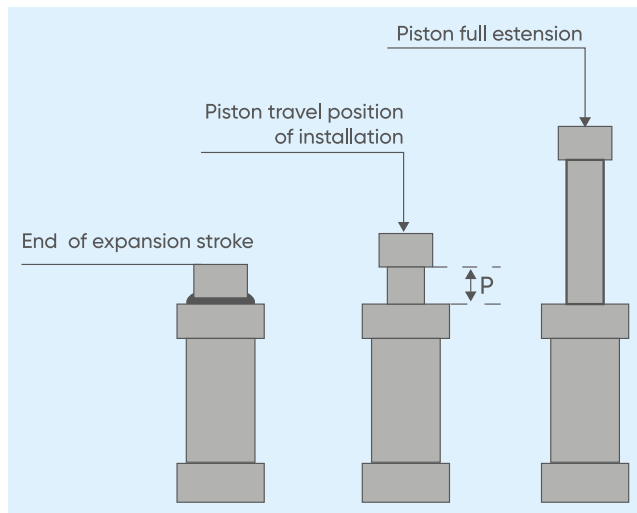

Sliding joints

These compensators consist of two sliding elements that allow the absorption of axial displacements of the pipes.

A sliding joint is shown in the following picture.

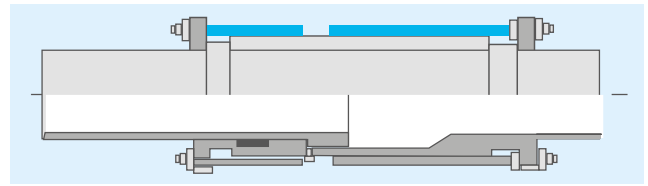

The bodies are in thermoplastic resins (UPVC, CPVC, PP and ABS) and equipped with O-ring elements, so they allow to absorb axial expansions between 150 and 600 mm.

Sliding joint is suggested when it is not possible to use expansion loops or direction changes, but its application for conveying encrusting fluids and solid suspension materials is not recommended.

To avoid instability phenomena, the long-excursion telescopic compensators are equipped with directional guides with stroke limiters, which guarantee coaxial sliding between the guide chamber and the piston. It is also necessary to subject them to periodic inspection and maintenance operations: in this way the state of the sealing elements is checked to exclude any leakage phenomena between the chamber and the piston that may arise due to the presence of encrustations and limited lubrication.

Flexible joints

Flexible compensators allow the absorption of axial and transverse expansions by distorting certain elements made of highly flexible materials, an example is shown in the next pictures.

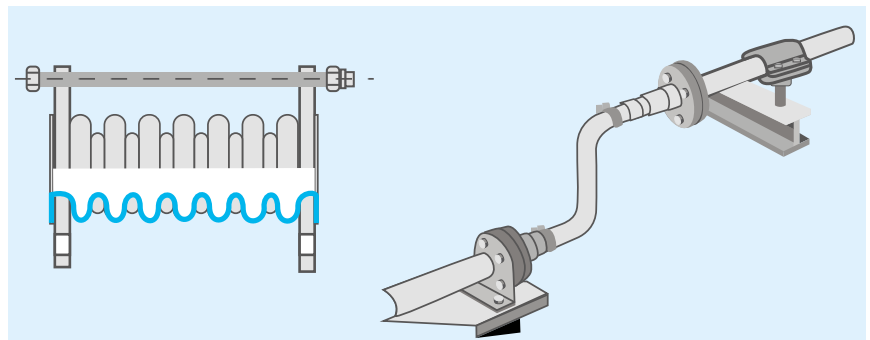

Two types of flexible compensators can be used: bellows and rubber joints.

The bellows compensators are made with corrugated elastic pluri-elements in PTFE which absorb axial expansions between 10 and 200 mm: they have the advantage of not having sealing parts that can suffer leaks and maintenance and are also used for the transport of aggressive substances at high temperatures.

The rubber compensators are similar to the bellows ones but are made with single elastic elements in elastomeric material. They are suitable for conveying dense substances and viscous fluids, their absorption capacity is limited and varies between 10 and 60 mm.

The flexible element is made of different elastomers, such as EPM and NBR are used for operating temperatures up to 90 °C. When the axial thermal displacements are extremely high or such as not to allow absorption through the conventional expansion joints, it is possible to use compensation elements obtained from pieces of flexible pipe, connected to the system by mechanical inserts. The limit of use of this flexible pipe must be determined according to the maximum operating temperature and pressure and the minimum bending radius allowed by the material.

Installation of expansion joints

The wrong or precarious installation of expansion joints has often been the main cause of various failures in thermal stressed pipes. Thermoplastic pipes are characterized by low modulus of elasticity, therefore the axial forces developed during a temperature change are relatively small when compared to metallic systems.

To make decisions on how to compensate for thermal effects it can be useful to calculate the stress present in the system. Restricting linear movement caused by thermal expansion and contraction results in thermal stress, that can be calculated by this equation:

$$S_t = E * \alpha * \Delta T$$

where:

S_t = thermal stress induced in the pipe (N/mm²)

E = modulus of elasticity (N/mm²)

α = coefficient of thermal expansion (mm/(mm * °C))

ΔT = (T_{max} - T_{install}) (°C)

Having the thermal stress of the system, the thermal end load on the piping and anchors can be determined by the following equation:

$$F_t = S_t * A = E * \alpha * \Delta T * A$$

where

F_t = pipe thermal end load (N)

$A = \pi/4 * (D_e^2 - D_i^2)$ = cross-sectional area of pipe (mm²)

E = modulus of elasticity (N/mm²)

α = unit linear coefficient of thermal expansion (mm/(mm*°C))

ΔT = difference between maximum and minimum temperature (°C)



Expansion joint must be selected and installed also to ensure the absorption of any possible pipe contraction due to temperature dropping.

Therefore it is necessary to select a precompression length of the expanding element before installing the expansion joint.

The amount of this length, called preset length and indicated by L^* , can be evaluate by using this equation:

$$L^* = R * \left(\frac{T_i - T_{min}}{T_{max} - T_{min}} \right)$$

where:

L^* = length of preset (mm)

R = stroke of expansion joint (mm)

T_i = installation temperature (°C)

T_{min} = minimum temperature (°C)

T_{max} = maximum temperature (°C)

Suitable anchors must be provided to sustain the direct pressure thrust as well as any other loading which may be imposed upon the expansion joints, while directional guides, installed along the expanding pipes, must assure that the joint is protected from all loads which cannot be carried and accommodated.

Installation of several expansion joints on one pipe run between two consecutive anchors is always unadvisable.

At this point it could be useful to understand where to where to place a telescopic joint within a system. Four different cases have been analysed:

Example A

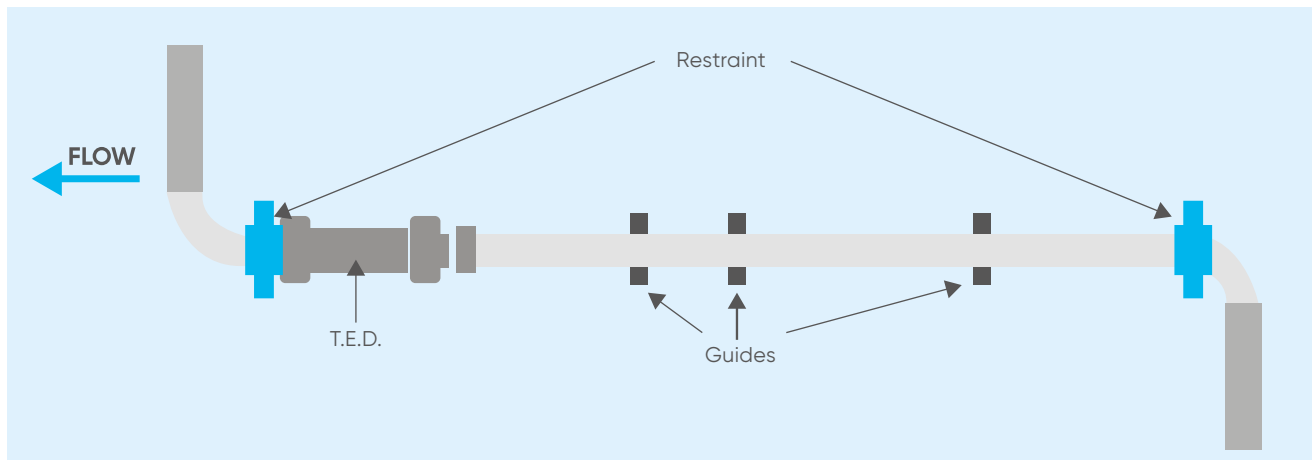

It shows a long pipe run, anchored at each end, which requires absorption of thermal expansion.

Calculations have determined that a single device can be used with intermediate pipe guides. It is recommended that the device be located as close as possible to the anchor at the end of the run (based on flow direction).

The first guide should be installed in the proximity of the connection between the pipe and the receiver on the moving arm of the compensator. This will ensure that the deflection is limited to the expected axial direction. The second guide is located relatively close to the first to avoid bowing of the pipe. Additional guides, evenly spaced, will be installed as needed.

Example B

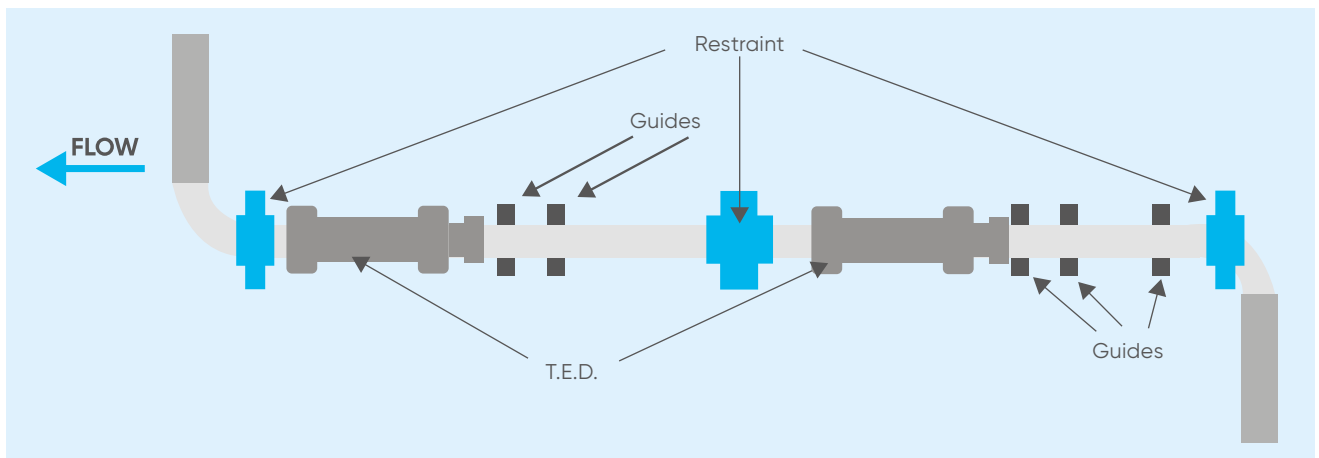

It illustrates an even longer pipe run.

Calculations have determined that two devices must be employed.

As a result, the run has been divided into two equal segments by a median anchoring point. A compensator is positioned at each end of the previously separated runs.

Guide placement is consistent with the outlines in Example A.

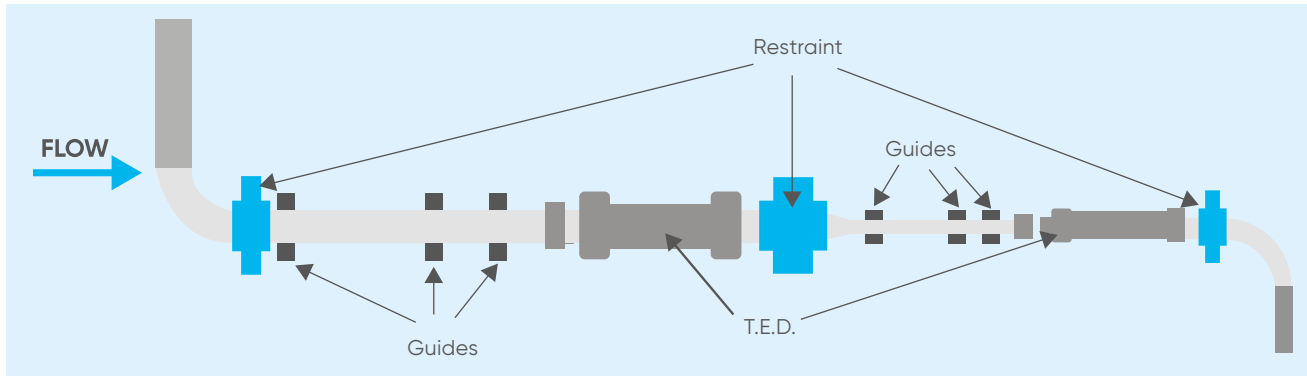
Example C

It illustrates a long run in which a larger diameter pipe is reduced to a smaller diameter near the middle of the run.

Although the amount of expansion in thermoplastic is not a function of the pipe diameter, should it be determined that two separate devices are needed, it is good practice to subdivide the run with an anchor at the transition point.

Subsequently identical procedures to those in Example B are to be followed.

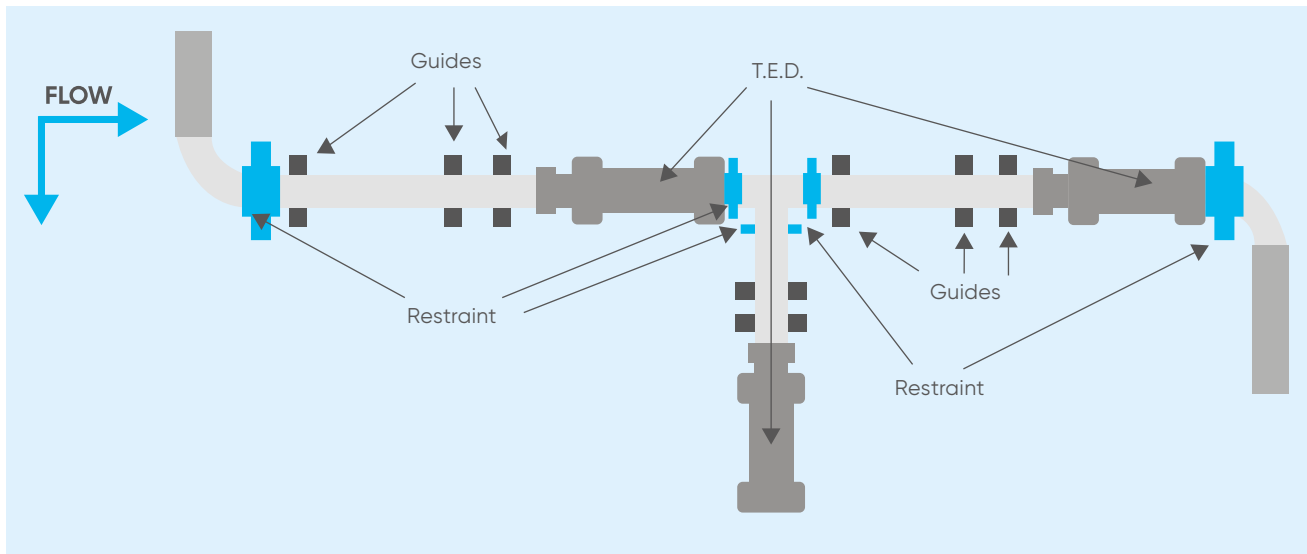
Example D

It illustrates the branching of a long run.

For the main pipe section an identical arrangement to that of Example B is

used, however a main anchor must be used at the TEE rather than the intermediate anchor. The main anchor is designed to resist the pressure thrust of the branch line.

In the direction of the main line the anchor must also resist any dynamic pressure thrust imbalance that results from the turbulence caused by the branch line.

Should the run in the branch line require it, a telescopic compensator will be installed following the procedure in Example A.

3.2.1.2 Offset

Expansion offset is used when the pipe needs to avoid fixed structure.

An example is shown in the picture.

Expansion offsets are usually placed in the centre of a pipe run.

Each elbow, as well as the vertical length of pipe, allow for some degree of deflection, while hangers or guides are used to set each pipe run.

As the pipe expands, the top and bottom elbows will push in, and this will cause the vertical length to angle to the right.

On the other hand, with contraction the vertical pipe will angle to the left.

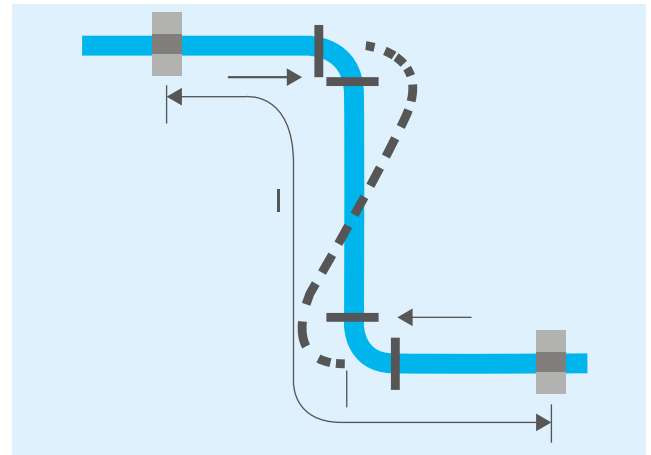

3.2.1.3 Expansion loops and direction changes

When the thermal expansion reaches high values the expansion compensators, due to the limited compression stroke, are uneconomical: in these cases expansion loops or direction changes are used.

In the next pictures a typical expansion loop and direction change is represented.

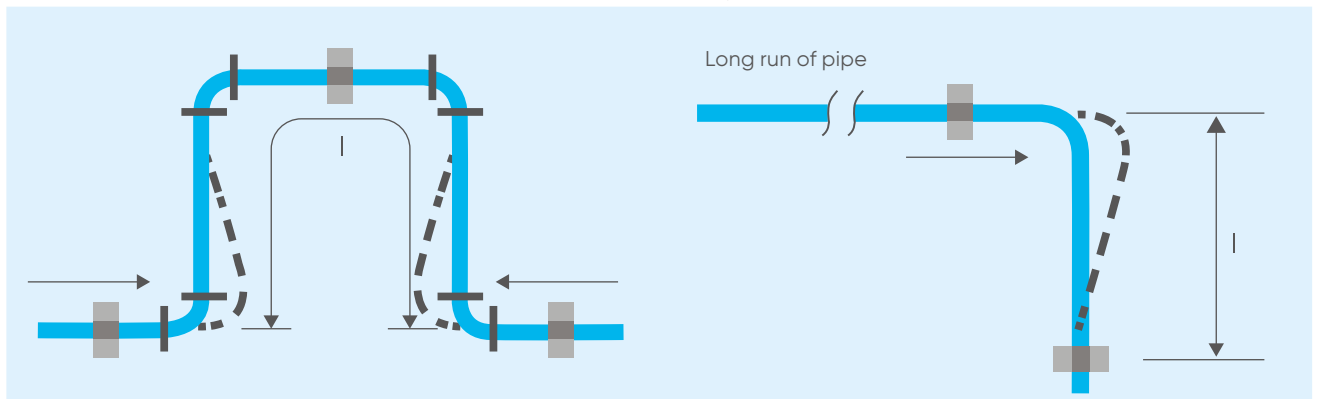

During an expansion the U opening of expansion loop narrows, while during a contraction the U opening widens.

Change of direction, on the other hand, allows for some degree of movement: during the expansion the corner moves out, while during the contraction the corner moves in.

It is recommended that expansion loops should be constructed with 90° elbows and straight pipe that are solvent welded together in order to handle the stressed during expansion more effectively.

The installation of expansion loops requires particular care by fitting suitable directional guides ensuring the alignment of expanding pipes: guide location must also guarantee that the expansion loop is only undergoing bending stresses and that the expanding pipes are free to move along their own longitudinal axis.

The design of expansion loops and changes of direction is based on the elastic properties of pipe and requires an analysis of pipeline flexibility.

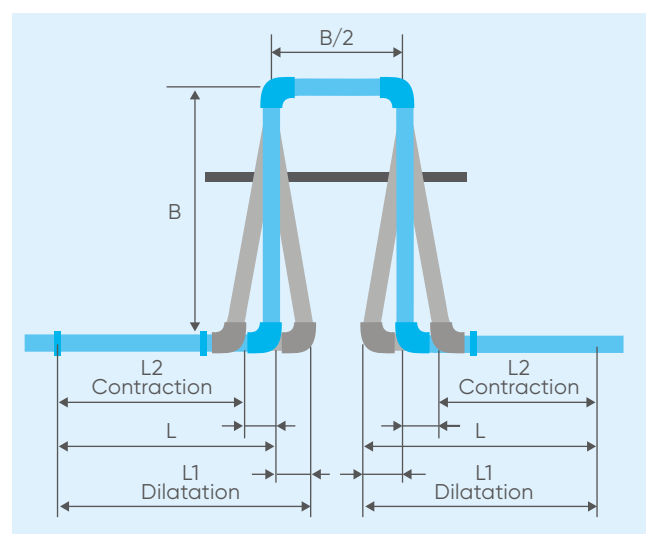

In addition, it is possible to notice that the loop width corresponds to the length B divided by 2.

To determine length B required to absorb the calculated expansion in the case of expansion loop it is suggested to use this equation:

$$B = 34 * \left(De * \frac{\Delta L}{2} \right)^{\frac{1}{2}}$$

where:

B = segment of the pipe (mm)

De = external diameter (mm)

ΔL = length deviation, remembering that $\Delta L = \alpha * L * \Delta T$

It is also possible to calculate the segment B using the following chart, always in function of the diameter of the pipe and the length deviation.

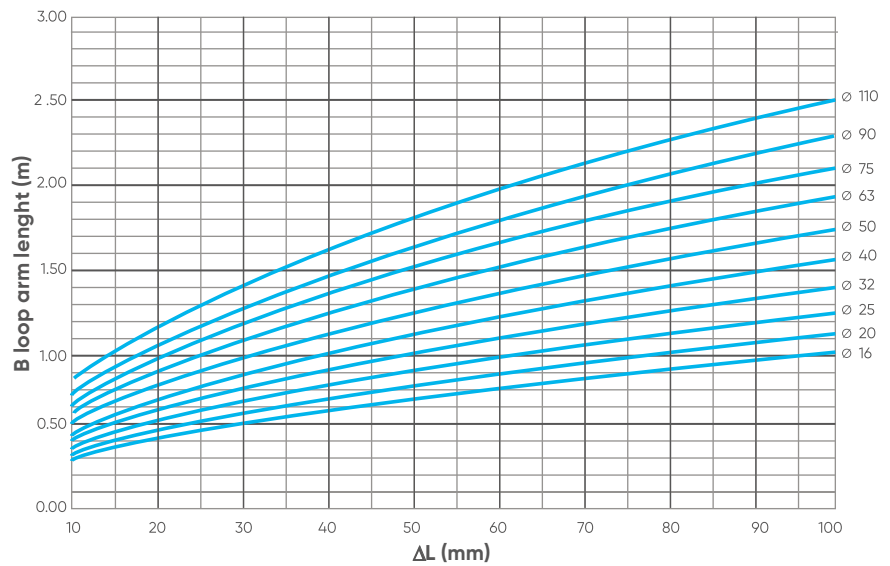

In the case of direction change, the distance B is the amount of distance required prior to placing anchor on the pipe from the elbow, as can be seen in the next picture.

As for expansion loop, by leaving the distance B free floating, the pipe can expand and contract freely to eliminate the stress present in the system.

Within B segment, it is still required to support the pipe according to the standard support spacing, but without fixing it tightly: the support should be smooth and free of sharp edges since the pipe will move back and forth.

At this point the length B required to absorb the calculated expansion in the case of direction change can be calculated by this equation:

$$B = 34 * \left(De * \Delta L \right)^{\frac{1}{2}}$$

where:

B = segment of the pipe (mm)

De = external diameter (mm)

ΔL = length deviation, remembering that $\Delta L = \alpha * L * \Delta T$

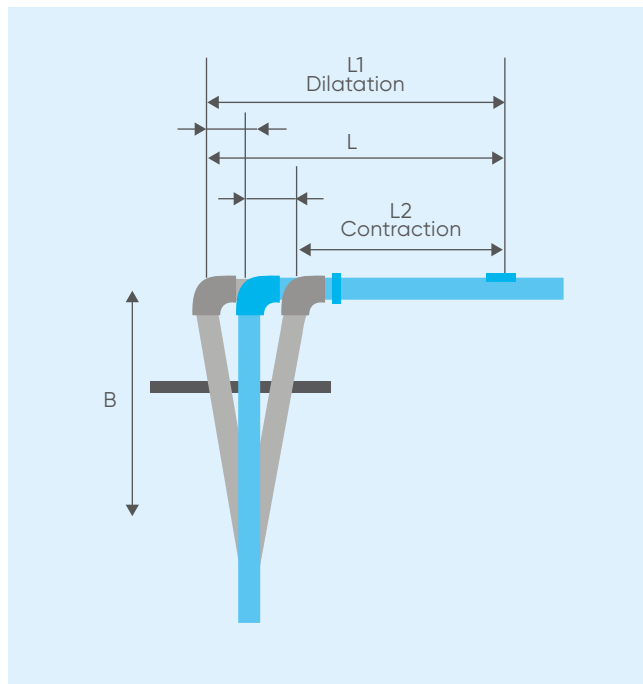

In addition, it is also possible to calculate the segment B using the following chart, always in function of the diameter of the pipe and the length deviation.

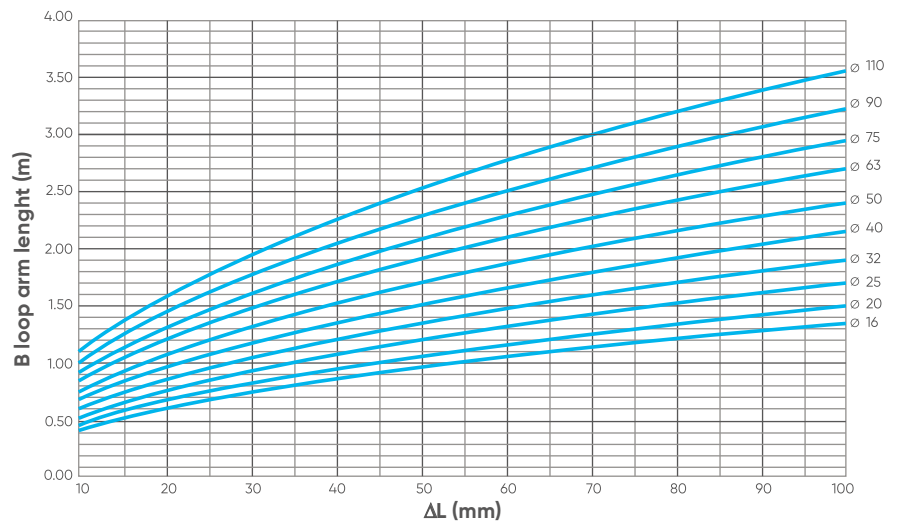

PRACTICAL EXAMPLE

To calculate segment B of a 6 meter long change of direction with a diameter of 90 mm and a $\Delta T = 40\text{ }^{\circ}\text{C}$ made of U-PVC.

Knowing that for U-PVC

$$\alpha = 0.00008\text{ }1/^{\circ}\text{C}$$

it is possible to calculate ΔL .

$$\Delta L = \alpha * L * \Delta T = 18,7\text{ mm}$$

In this way, by applying the equation, B can be found.

$$B = 34 * (De * \Delta L)^{\frac{1}{2}} = 1,4\text{ m}$$

Alternatively, knowing the value of ΔL and De it is possible to derive the value of B from the graph, as shown in the figure.

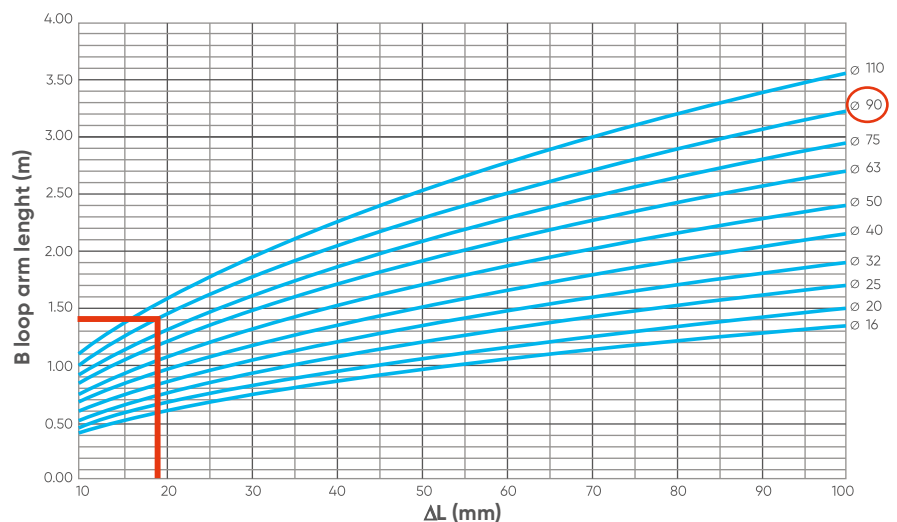

3.2.2 Heat tracing

In a chemical process temperature control is required in the case of fluids which, with the lowering of temperature, can cause problems during operation, for example an increase in viscosity, a transition to a solid state, separation of components, precipitation of suspended substances, decomposition and so on.

There are some very reliable methods of providing freeze protection and temperature maintenance: external electrical tracking using "self-regulating" type electric heaters and the method of insulation by means of double containment like the AkathermThermoPlus product range.

External self-regulating heat tracing design

Plastic pipes melt at relatively low temperatures compared to metal pipes: if temperatures are sufficiently high, the outer walls of a plastic pipe can char or burn. Due to these characteristics, the only recommended type of electric heat detector is the self-regulating type: by automatically varying the thermal power and providing the necessary heat, the heater compensates for installation and operating variables such as voltage fluctuations, heat sinks and variations in ambient temperature.

Self-regulation works through the use of a self-regulating cable with a semiconducting matrix composed of a mixture of polymer and conductive carbon extruded onto two conductors.

At first this matrix is irradiated to fix its structure and an initial memory.

The carbon molecules form conductive chains between them, which can be considered as many small electrical resistances placed in parallel between the two conductors; when the conductors are powered at one end and insulated on the opposite side of the circuit, electric current passes through these resistors producing heat.

As the temperature of the cable increases, the polymer molecules expand and break the carbon chains, as can be seen in the photo, so consequently the power decreases.

Because of the initial irradiation, the matrix has memorized its initial molecular structure, so the phenomenon is reversible: in fact, when the temperature of the cable decreases, the material comes back to its initial conditions.

To correctly design a system with electrical heat tracking, it is necessary to know some variables, such as design temperature difference voltage, area, environment and total pipe length.



Then the following steps should be followed:

- 1) To select the appropriate heater according to the maximum exposure temperature and desired maintenance temperatures.
- 2) To select an appropriate heater according to the thermal output curves for that particular heater, so that the thermal output at the holding temperature is equal to or greater than the heat loss.
- 3) If the calculated heat loss is greater than the power supplied by the heater it is suggested to follow these tips:

- use thicker insulation;
- use insulation with lower thermal conductivity;
- use two or more parallel strips;
- use spiral thermal trace.

In the following picture an example of how to collocate the tape on pipe is shown.

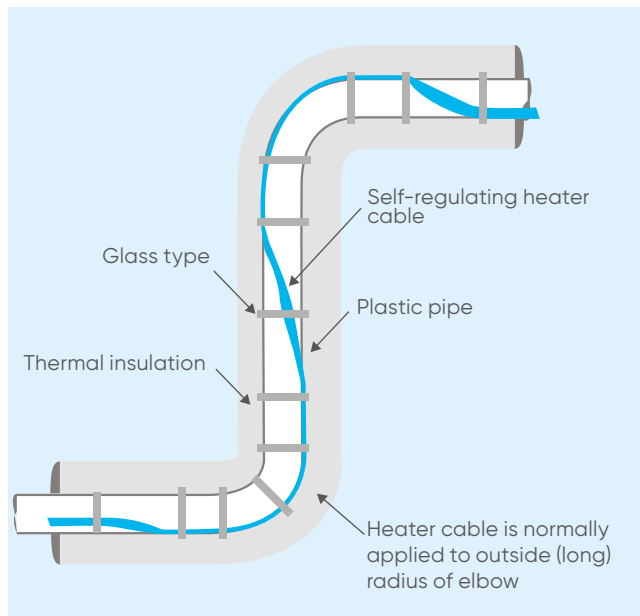

AkathermThermoPlus

In general, double containment systems are used to transport fluids or dangerous substances. AkathermThermoPlus is a double containment system that also allows to obtain anti-freeze protection or the maintenance of a certain temperature inside the pipe by means of a heating cable.

In general, a double containment pipe consists of a protective pipe, spacers, internal pipe, as can be seen in the picture.

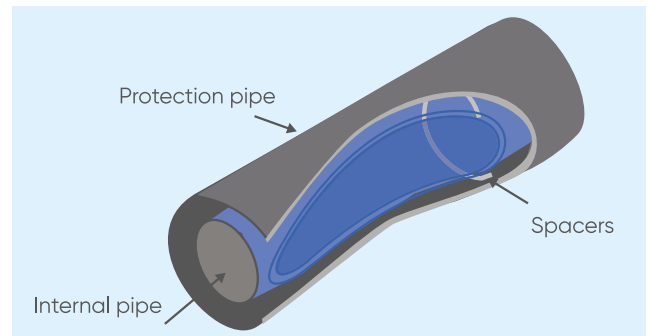

The AkathermPlus annular design can be presented in three different variants depending on the final application:



In particular in the following photo it is possible to analyze the internal structure of the system, it is necessary to remember that the material of which the pipe is made is PE-HD.

AkathermThermoPlus can be used in different areas of application, for example in industrial and chemical plants, in power plants, in sewage systems or in the food industry.

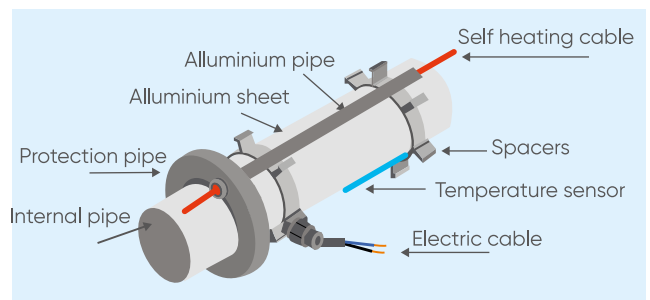

3.2.3 Pipelines anchoring

Pipeline anchoring plays an important role for the proper operation of the piping systems. A pipe must be supported following a proper span in order to preserve the durability of the piping system.

Thermoplastic pipelines are characterized by high coefficients of thermal expansion and low axial modulus of elasticity, therefore an adequate supporting systems are required to bear the permanent loads generated by the weight of pipes and fittings and to absorb the mechanical stresses developed by temperature changes.

Selection of support types and their location will depend upon operating conditions and pipe lay-out as well as upon restrictions imposed on pipe stresses and movements.

With the aid of suitable pipe supports, piping loads produced due to pressure, temperature, weight or occasional event must be transmitted from pipe to supporting structures.

Laying systems for plastic pipes

When planning and laying thermoplastic piping systems, the material characteristics must always be taken into account. The design of a reliable piping system depends on the professional application and processing of the plastics. The following information are intended as a guide, especially for the planning side. The picture below shows a general differentiation in the installation method of a plastic piping systems.

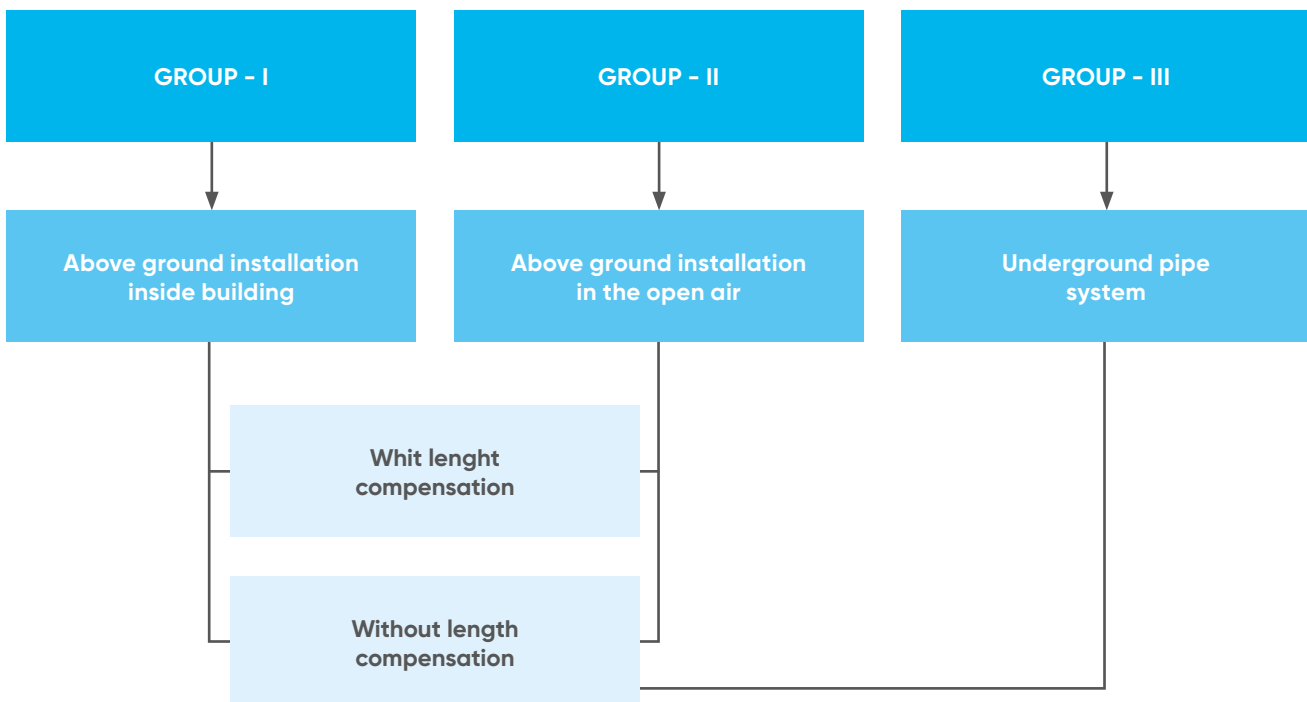

Group-I and Group-II form the above-ground installed plastic piping systems with and without length compensation inside buildings or outside. These systems generally require a support structure and are used, for example, in the chemical industry, in sewage treatment plants and in swimming pool construction. They usually require the greatest processing effort.

Group-III pipelines (underground piping systems) are, for example, part of municipal water networks. However, they are just as frequently installed in the field of industrial wastewater technology. Due to the flexibility of plastic pipes, the cost of underground work is lower than that of laying steel, cast iron or concrete pipes.

Concreted pipelines are a special form of underground pipelines. Due to the lack of or limited accessibility for maintenance, the special form of laying should be reserved for low-stress gravity or drainage pipes. Encasing in concrete transforms a flexible pipe into a rigid structure with no flexural strength, annihilating many benefits of plastic pipe systems.

3.2.3.1 Piping Support and Pipe Restraint

The term restraint is invariably used for piping supports.

Anyway, there is a little difference between pipe support and restraint: pipe supports are used to support the piping system by carrying the vertical load whereas pipe restraints limit the movements of the pipe so takes care of the horizontal loads. Pipe support and restraints combinedly can be said pipe support systems.

Pipe supports

Brackets have the task of safely absorbing all loads of a pipeline and transferring them to a building or substructure. Due to the limited and temperature-dependent strength and dimensional stability of thermoplastic pipelines, the requirements are different from those for metallic pipelines.

When laying the piping, the first step is to install the support system which is to hold the pipeline strands. This procedure avoids the use of unnecessary auxiliary constructions and unsuitable provisional arrangement and, in addition, it is a safe installation method which largely excludes unacceptable loads on the pipeline during installation.

The reverse procedure, such as adapting the supports to pipes already installed and temporarily fixed, is only allowed in exceptional cases since the subsequent installation of the planned supports can involve constraints that limit the operational safety of the pipeline. In the case of larger pipelines, the risk of failure and its consequences increases if the temporary supports are not subjected to a strength assessment. Such a procedure is therefore not permitted.

In principle, the pipe support must be classified according to its function.

Plain bracket (GL)

The plain bracket in a horizontally laid pipeline can only absorb vertically directed forces (loads). Above all, it should provide the lowest possible resistance to the operation-related changes in length of the pipeline. Freedom of movement must be given both in the longitudinal direction of the pipe and transverse to the pipe axis.

Guide bracket (FL)

The guide bracket must prevent the pipeline from sliding sideways. It is therefore capable of absorbing transverse forces and is required, for example, in axially clamped pipe sections to prevent buckling. Depending on its function, the guide bearing can be fixed or movable in the direction of the pipe axis. Sliding the pipe in the clamp, as a replacement for a guide bearing with sliding shoe, is an unsafe solution and must therefore be ruled out.

Fixed point (FP)

Fixed points are intended to prevent the displacement of individual pipe sections in any direction. They also serve to absorb reaction forces when compensators or sliding and plug-in sleeves are used. Fixed points must be installed in such a way that the changes in length in the pipe system can be assigned to the compensation elements in size and direction.

Horizontal pipe runs (HL)

Support locations of horizontal pipe runs are depending on the already existing structures that are available for the support of the piping and the location of concentrated loads, such as valve and heavy pipeline equipments. To minimize bending and shear stresses due to static loads is the main goal in support location design. Supports spacing are therefore based on the allowable total stress of the pipe and on the pre-fixed amount of allowable deflection between supports.

To get the length between supports, it is suggested to look at the tables in the next chapter.

This length varies according to pipe materials, dimensions and temperatures.

Vertical pipe runs (VL)

Risers or vertical pipe runs may be supported following the same guide spacing used for horizontal pipes. However, a reduction of the distance between adjacent guides is suggested to prevent columnar instability.

Support locations

In a thermoplastic pipeline, support location cannot be determined by pre-established rules since every single time different engineering factors make one solution more appropriate than another.

Pipe dimensions and materials, pipeline configurations, valves and fittings location, availability of attachments to building or other structures, thermal expansions and vibrations generating sources, overloads developed by earthquakes and atmospheric agents may prove binding factors to be taken into account by the engineer to determine the correct position of every single support.

The purpose of this paragraph is therefore to provide general criteria and suggestions apt to assist the design engineer in his study.

The paragraph following by contains the specific information regarding pipe clips support spacing for different materials according to DVS 2210 standards.

Pipe clip supports

The installation of thermoplastic pipe systems requires the use of support clips to prevent flexing and the resulting mechanical stresses. When laying pipelines, both the pipe support widths and the mounting distances has to be considered. Both terms describe the fastening of pipelines with the difference that on the one hand the permissible deflection of the pipeline and on the other hand the buckling of the pipeline is saved.

When determining the span width based on the permissible deflection, the pipeline is regarded as a so-called continuous beam, in which only the end sections (before and after the pipe bend) are flexible.

When determining the span width based on the permissible buckling (pipe span widths for clamped pipe systems), the plastic pipeline must be checked against possible lateral buckling. The smaller of the two determined span values define the minimum pipe support width to be maintained.

The distance between the clips depends on the pipe material, SDR, surface temperature and the density of the conveyed fluid.

Before installing the clips, check the distances reported in the tables below, which is in accordance to DVS 2210-01 guidelines for water pipes.

Aliaxis in its range of products offers four types of pipe clips, shown in the next table.

The decision on which to choose depends on several variables such as, for example, the material and the DN range.

COBRA	MONOKLIP	FIP-GOEMA	ASTORE
			

3.2.3.2 Tables and Graphs

To avoid performing calculations, it is possible to take into account the following tables and graphs that show the customary spans of thermoplastic pipes according to DVS 2210-1. They are based on experimental data.

Pipe support spacing for UPVC

Pipe size De (mm)	Nominal diameter DN	Support span width (LA) in mm at room temperature (TR)				
		20°C	30°C	40°C	50°C	60°C
16	10	950	900	850	750	600
20	15	1100	1050	1000	900	700
25	20	1200	1150	1050	950	750
32	25	1350	1300	1250	1100	900
40	32	1450	1400	1350	1250	1000
50	40	1600	1550	1500	1400	1150
63	50	1800	1750	1700	1550	1300
75	65	2000	1900	1850	1700	1450
90	80	2200	2100	2000	1850	1550
110	100	2400	2250	2250	2050	1750
125	100	2550	2400	2400	2200	1850
140	125	2700	2600	2500	2300	1950
160	150	2900	2800	2700	2500	2100
180	150	3100	2950	2850	2650	2200
200	200	3250	3150	3000	2800	2350
225	200	3450	3300	3200	2950	2500
250	250	3650	3500	3350	3100	2600
280	250	3750	3700	3550	3300	2750
315	300	4100	3900	3750	3500	2950
355	350	4300	4200	4000	3700	3100
400	400	4600	4450	4250	3950	3300

 Marked region: SDR 13.6 / S 6.3 / PN 16.

 Other region: SDR 21 / S 10 / PN 10.

For different SDR values, multiply the data in the table by the following factors:

- 1.08 for SDR 13,6 / S6.3 / PN16 : size range De 25 – 400;
- 1.15 for SDR 11 / S5 / PN20 : entire size range.

It is important to remember that, according to the transported substance, the support span width has to be multiplied by the factor in the table.

Material	PN	Transported substances		
		Water	Others	
			Density (g/cm ³)	
		1	1.25	1.50
UPVC	10	1	0.96	0.92
	16			
	20			

Pipe support spacing for CPVC

Pipe size De (mm)	Nominal diameter DN	Support span width (LA) in mm at room temperature (TR)							
		20°C	30°C	40°C	50°C	60°C	70°C	80°C	90°C
16	10	1000	950	900	850	750	675	600	500
20	15	1150	1100	1025	950	875	775	700	600
25	20	1200	1150	1100	1000	900	800	700	600
32	25	1350	1250	1200	1100	1000	900	800	700
40	32	1500	1400	1300	1250	1150	1050	900	800
50	40	1650	1600	1500	1400	1300	1200	1100	900
63	50	1850	1750	1650	1600	1500	1350	1250	1050
75	65	2050	1950	1850	1750	1650	1500	1350	1200
90	80	2250	2100	2000	1900	1800	1650	1500	1300
110	100	2500	2350	2200	2100	1950	1800	1650	1450
125	100	2650	2500	2350	2250	2100	1950	1750	1550
140	125	2800	2650	2500	2350	2200	2050	1850	1650
160	150	3000	2850	2700	2550	2400	2200	2000	1750
180	150	3150	3000	2850	2700	2500	2300	2100	1850
200	200	3350	3150	3000	2850	2650	2450	2200	1950
225	200	3550	3350	3200	3000	2800	2600	2350	2100
250	250	3750	3550	3350	3150	3000	2750	2500	2200
280	250	3950	3750	3550	3350	3150	2900	2650	2350
315	300	4200	4000	3750	3550	3350	3050	2800	2450
355	350	4450	4250	4000	3800	3550	3250	2950	2650
400	400	4750	4500	4250	4000	3750	3450	3150	2800

 Marked region: SDR 13.6 / S 6.3 / PN 16.

 Other region: SDR 21 / S 10 / PN 10.

For different SDR values, multiply the data in the table by the following factors:

- 1.08 for SDR 13,6 / S6.3 / PN16 : size range De 40 - 400;
- 1,12 for SDR 11 / S 5 / PN20 : entire size range

It is important to remember that, according to the transported substance, the support span width has to be multiplied by the factor in the table.

Material	PN	Transported substances		
		Water	Others	
		Density (g/cm ³)		
		1	1.25	1.50
CPVC	10	1	0.96	0.92
	16			
	20			

Pipe support spacing for ABS

In addition to what reported on DVS rules for polyvinyl chloride and polyolefins, for ABS our expert recommends these values.

Pipe size De (mm)	Nominal diameter DN	Support span width (LA) in mm at room temperature (TR)		
		20°C	50°C	60°C
16	10	800	500	400
20	15	900	600	500
25	20	1000	700	600
32	25	1100	800	700
40	32	1200	900	700
50	40	1300	1000	700
63	50	1400	1100	800
75	65	1500	1200	800
90	80	1600	1200	900
110	100	1800	1300	1000
125	100	1900	1400	1000
140	125	2000	1500	1100
160	150	2100	1600	1200
200	150	2200	1700	1300
225	200	2300	1800	1500
250	250	2500	2000	1700
315	300	2900	2400	2100

The values in the table is based on Class C pipe in each size. For sizes 32 mm, 40 mm, 50 mm, 63 mm, 75 mm, 90 mm, and 110 mm the support distance can be increased by 10% for class E pipes.

In addition it is important to remember that, if the transported substance has a specific gravity greater than 1, the distance must be decreased by dividing the recommended centre distances by the specific gravity.

Pipe support spacing for PP

Pipe size De (mm)	Nominal diameter DN	Support span width (LA) in mm at room temperature (TR)						
		20°C	30°C	40°C	50°C	60°C	70°C	80°C
16	10	650	625	600	775	550	525	500
20	15	700	675	650	625	600	575	550
25	20	800	775	750	725	700	675	650
32	25	950	925	900	875	850	800	750
40	32	1100	1075	1050	1000	950	925	875
50	40	1250	1225	1200	1150	1100	1050	1000
63	50	1450	1425	1400	1350	1300	1250	1200
75	65	1550	1500	1450	1400	1350	1300	1250
90	80	1650	1600	1550	1500	1450	1400	1350
110	100	1850	1800	1750	1700	1600	1500	1400
125	100	2000	1950	1900	1800	1700	1600	1500
140	125	2100	2050	2000	1900	1800	1700	1600
160	150	2250	2200	2100	2000	1900	1800	1700
180	150	2350	2300	2200	2100	2000	1900	1800
200	200	2500	2400	2300	2200	2100	2000	1900
225	200	2650	2550	2450	2350	2250	2150	2000
250	250	2800	2700	2600	2500	2400	2300	2150
280	250	2950	2850	2750	2650	2550	2450	2300
315	300	3150	3050	2950	2850	2700	2600	2450
355	350	3350	3250	3150	3000	2850	2750	2600
400	400	3550	3450	3350	3200	3050	2900	2750

The values in the table correspond to SDR 11/S 5/PN 10.

The distance can be increased by 30% in case of vertical installation of the pipe.

For different SDR values, multiply the data in the table by the following factors:

- 0.91 for SDR 17.6 / S 8.3 / PN 6.

It is important to remember that, according to the transported substance, the support span width has to be multiplied by the factor in the table.

Material	PN	Transported substances		
		Water	Others	
		Density (g/cm ³)		
		1	1.25	1.50
PP	6	1	0.96	0.92
	10			

Pipe support spacing for PE-HD

Pipe size De (mm)	Nominal diameter DN	Support span width (LA) in mm at room temperature (TR)				
		20°C	30°C	40°C	50°C	60°C
16	10	500	450	450	400	350
20	15	575	550	500	450	400
25	20	650	600	550	550	500
32	25	750	750	650	650	550
40	32	900	850	750	750	650
50	40	1050	1000	900	850	750
63	50	1200	1150	1050	1000	900
75	65	1350	1300	1200	1100	1000
90	80	1500	1450	1350	1250	1150
110	100	1650	1600	1500	1450	1300
125	100	1750	1700	1600	1550	1400
140	125	1900	1850	1750	1650	1500
160	150	2050	1950	1850	1750	1600
180	150	2150	2050	1950	1850	1750
200	200	2300	2200	2100	2000	1900
225	200	2450	2350	2250	2150	2050
250	250	2600	2500	2400	2300	2100
280	250	2750	2650	2550	2400	2200
315	300	2900	2800	2700	2550	2350
355	350	3100	3000	2900	2750	2550
400	400	3300	3150	3050	2900	2700

The values in the table correspond to SDR 17 / S8 / PN10.

For vertically laid pipes, the support distances can be multiplied by 1.3.

For different SDR values, multiply the data in the table by the following factors:

- 0.91 for SDR 26 / S 12.5 / PN 6;
- 1.07 for SDR 11 / S 5 / PN 16.

It is important to remember that, according to the transported substance, the support span width has to be multiplied by the factor in the table.

Material	PN	Transported substances		
		Water	Others	
		Density (g/cm ³)		
		1	1.25	1.50
PE-HD	6	1	0.96	0.92
	10			
	16			

Pipe support spacing for PVDF

Pipe size De (mm)	Nominal diameter DN	Support span width (LA) in mm at room temperature (TR)								
		20°C	30°C	40°C	50°C	60°C	70°C	80°C	100°C	120°C
16	10	725	700	650	600	575	550	500	450	400
20	15	850	800	750	750	700	650	600	500	450
25	20	950	900	850	800	750	700	675	600	500
32	25	1100	1050	1000	950	900	850	800	700	600
40	32	1200	1150	1100	1050	1000	950	900	750	650
50	40	1400	1350	1300	1200	1150	1100	1000	900	750
63	50	1400	1350	1300	1250	1200	1150	1100	950	800
75	65	1500	1450	1400	1350	1300	1250	1200	1050	850
90	80	1600	1550	1500	1450	1400	1350	1300	1100	950
110	100	1800	1750	1700	1650	1550	1500	1450	1250	1100
125	100	1900	1850	1800	1700	1650	1600	1500	1350	1200
140	125	2000	1950	1900	1800	1750	1700	1600	1450	1250
160	150	2150	2100	2050	1950	1850	1800	1700	1550	1350
180	150	2300	2200	2150	2050	1950	1900	1800	1600	1400
200	200	2400	2350	2250	2150	2100	2000	1900	1700	1500
225	200	2550	2500	2400	2300	2200	2100	2000	1800	1600
250	250	2650	2600	2500	2400	2300	2200	2100	1900	1700
280	250	2850	2750	2650	2550	2450	2350	2250	2000	1800
315	300	3000	2950	2850	2750	2600	2500	2400	2150	1900
355	350	3200	3100	3000	2850	2750	2650	2500	2250	2000
400	400	3400	3300	3200	3050	2950	2800	2650	2400	2100

 Marked region: SDR 21 / S 10 / PN 16

 Other region: SDR 33 / S 16 / PN 10

For different SDR values, multiply the data in the table by the following factors:

- 1.08 for SDR21 / S10 / PN16 : size range De 63 - 400;
- 1.12 for SDR17 / S8 / PN20: entire size range.

It is important to remember that, according to the transported substance, the support span width has to be multiplied by the factor in the table.

Material	PN	Transported substances		
		Water	Others	
		Density (g/cm ³)		
		1	1.25	1.50
PVDF	10	1	0.96	0.92
	16			
	20			

The graphs below are generated from the pipe support spacing tables according to DVS 2210-1.

Graph Pipe support spacing UPVC

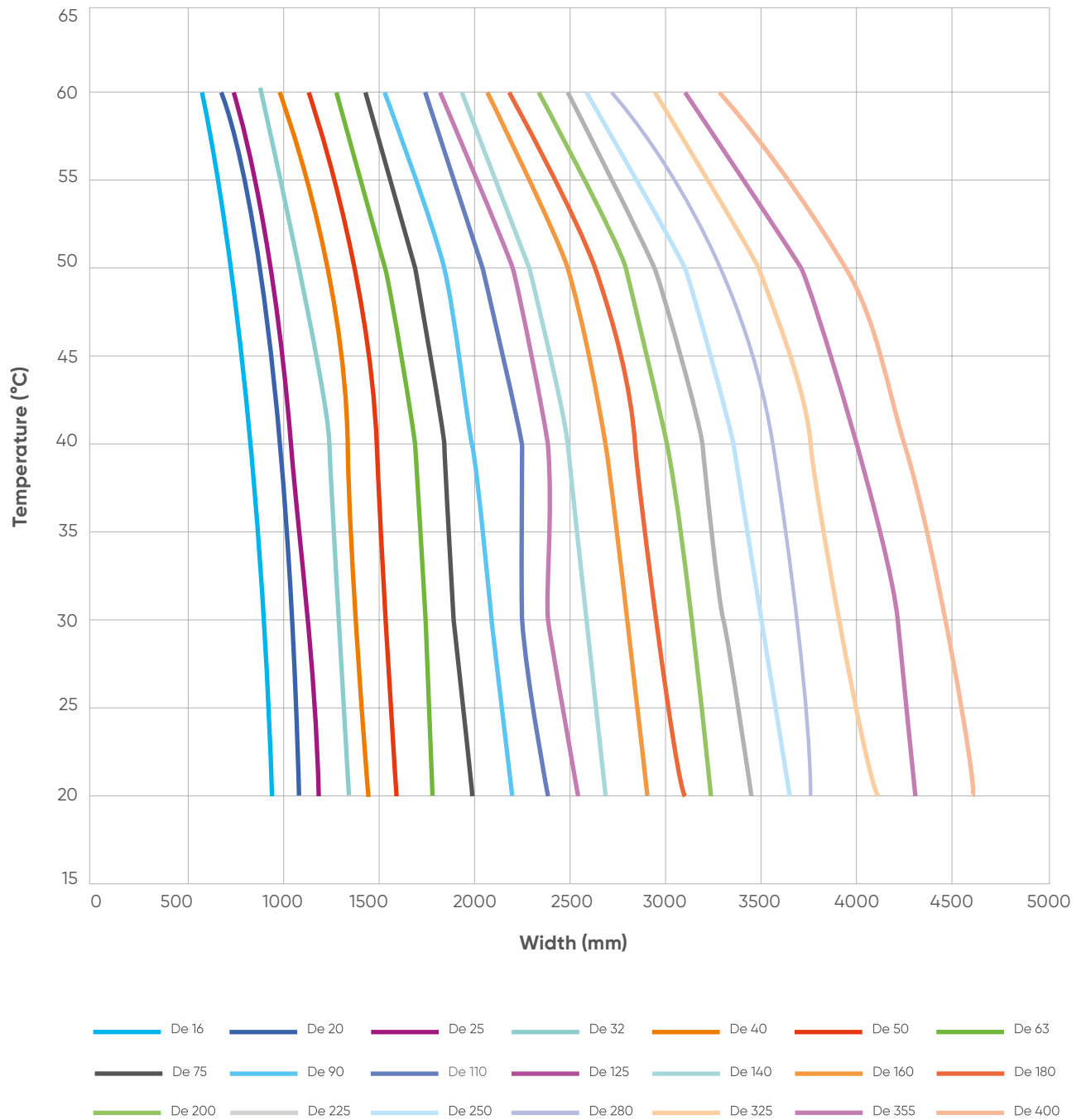

Graph Pipe support spacing CPVC

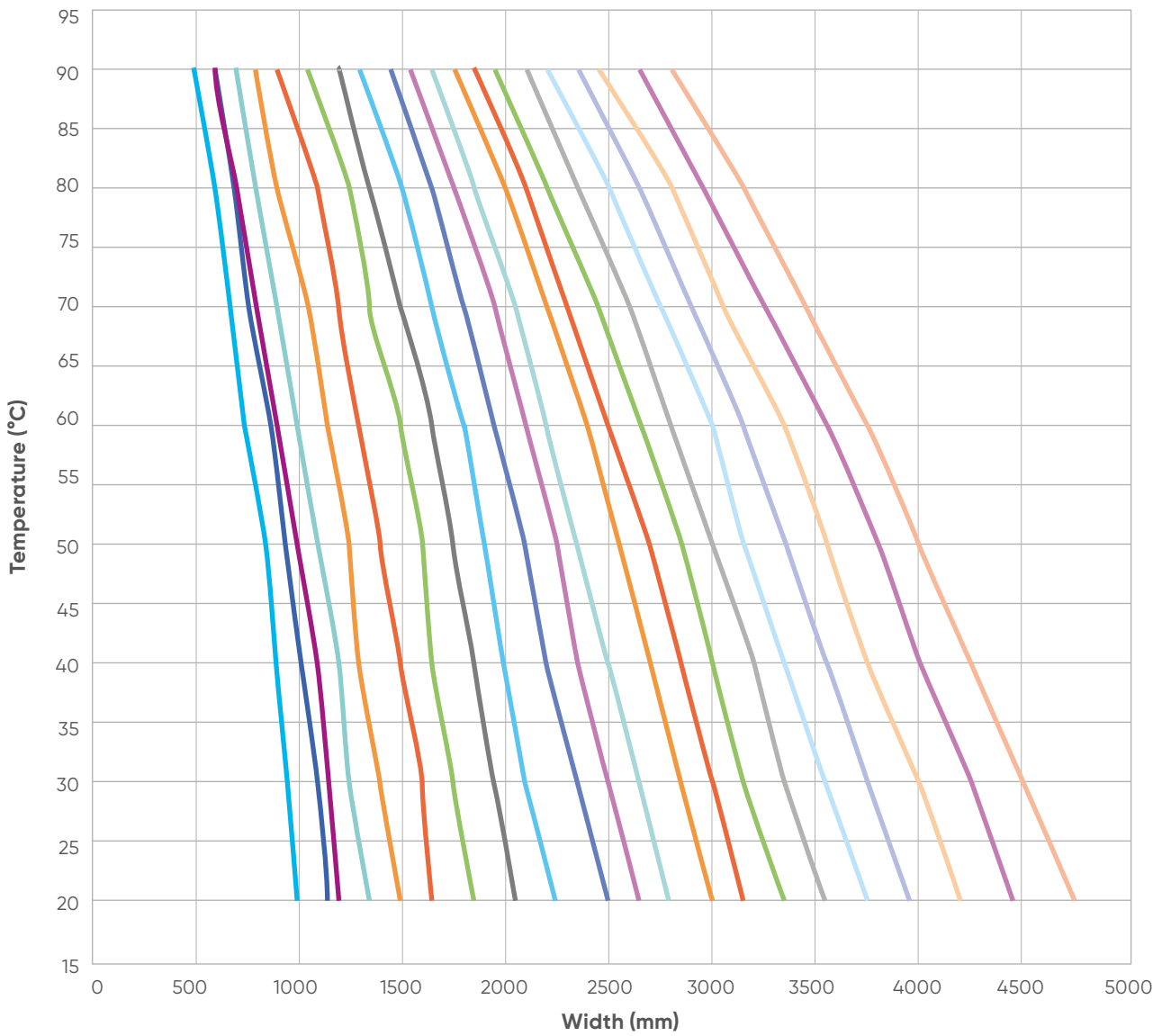

- | | | | | | | |
|--------|--------|--------|--------|--------|--------|--------|
| De 16 | De 20 | De 25 | De 32 | De 40 | De 50 | De 63 |
| De 75 | De 90 | De 110 | De 125 | De 140 | De 160 | De 180 |
| De 200 | De 225 | De 250 | De 280 | De 325 | De 355 | De 400 |

Graph Pipe support spacing ABS

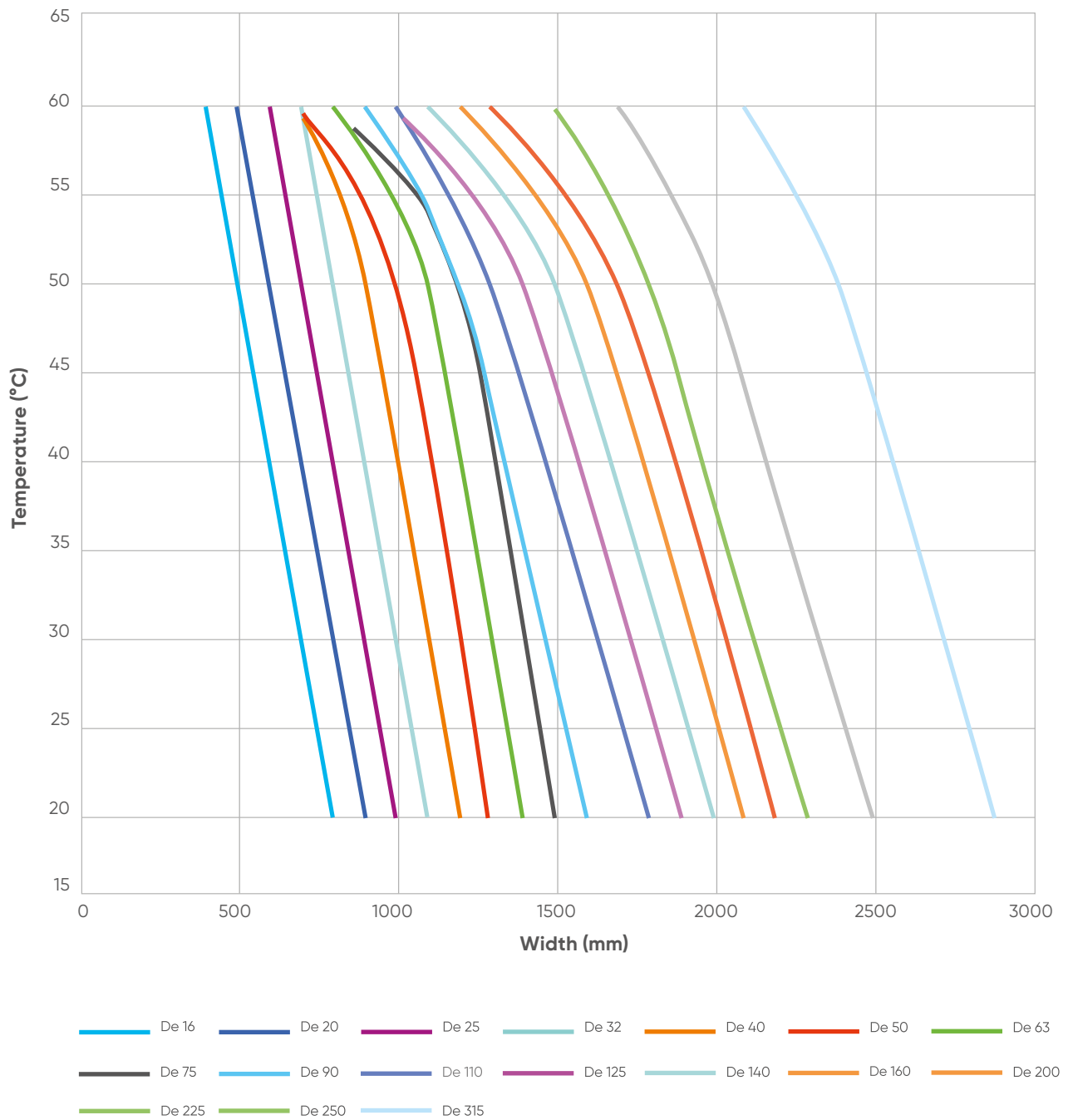

Graph Pipe support spacing PP

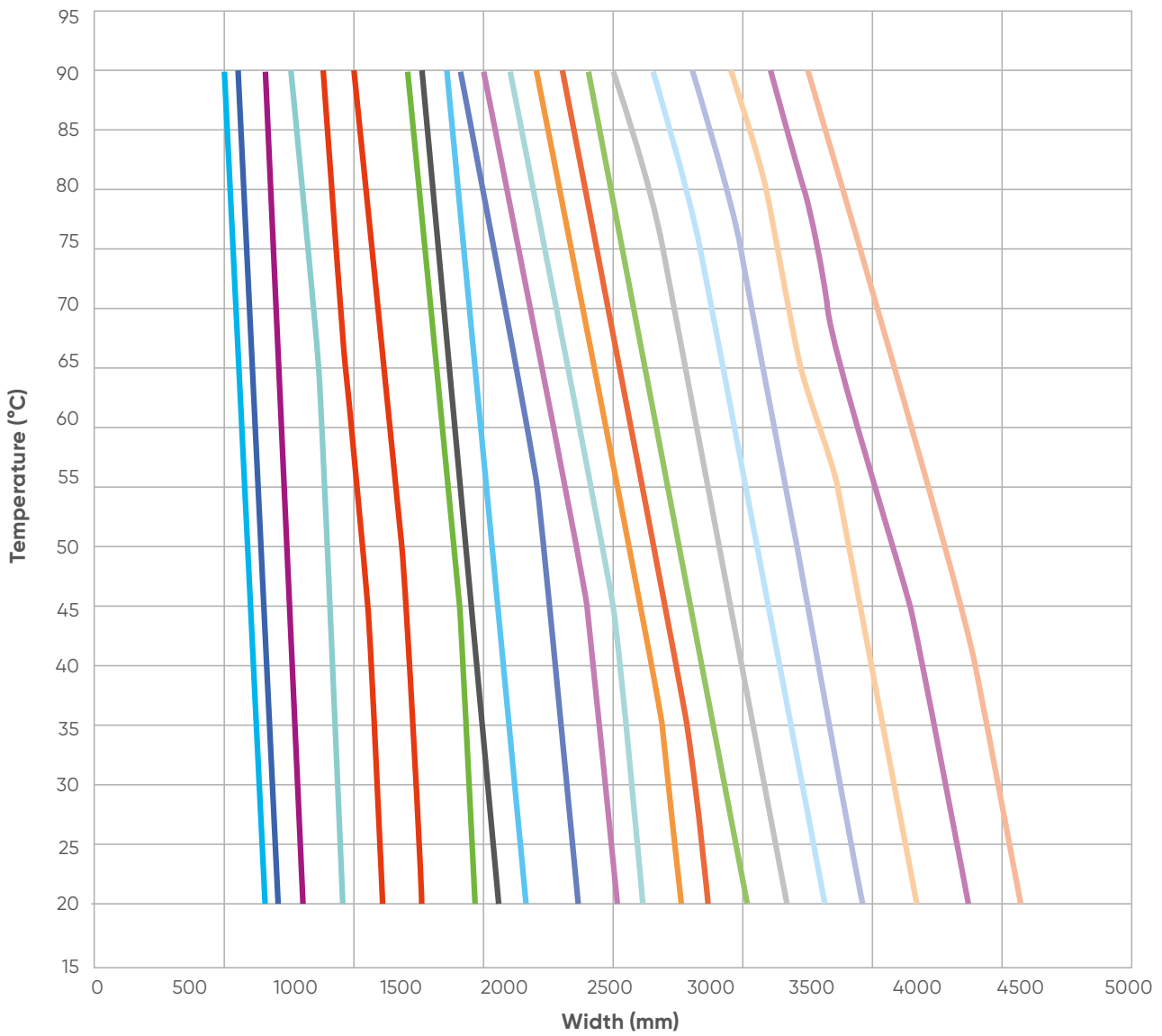

- De 16 De 20 De 25 De 32 De 40 De 50 De 63
- De 75 De 90 De 110 De 125 De 140 De 160 De 180
- De 200 De 225 De 250 De 280 De 325 De 355 De 400

Graph Pipe support spacing PE

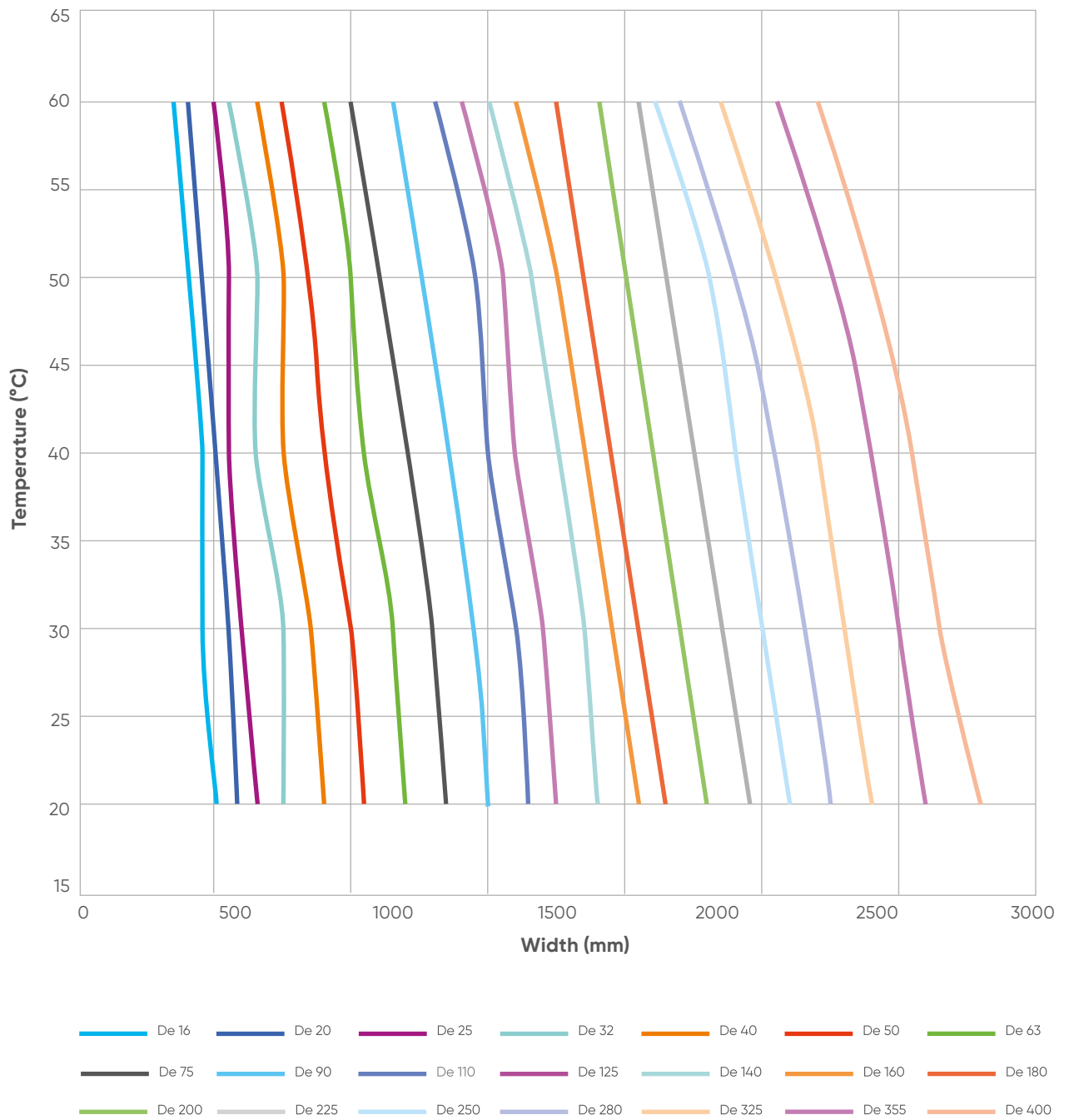

Graph Pipe support spacing PVDF

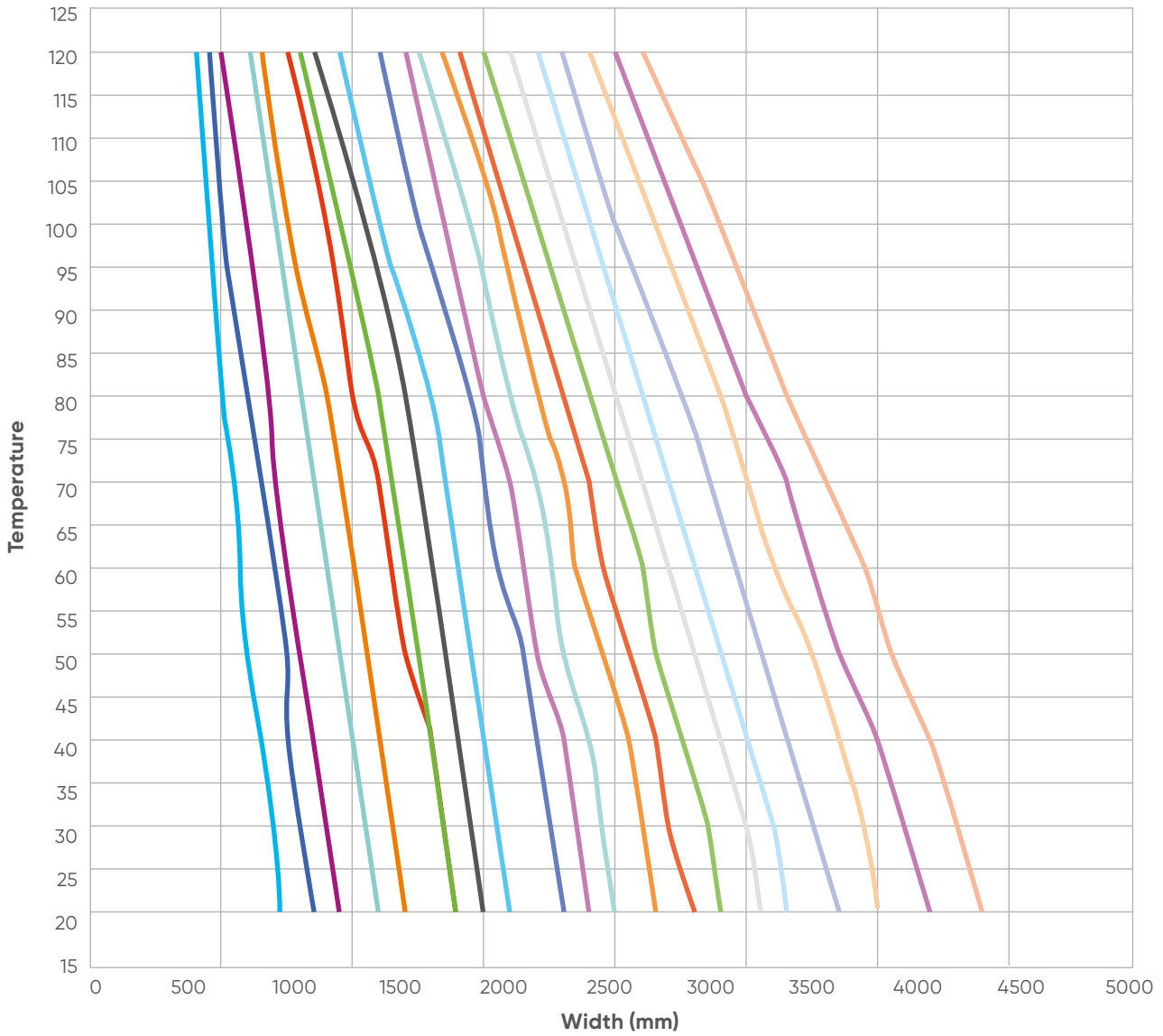

- De 16
- De 20
- De 25
- De 32
- De 40
- De 50
- De 63
- De 75
- De 90
- De 110
- De 125
- De 140
- De 160
- De 180
- De 200
- De 225
- De 250
- De 280
- De 325
- De 355
- De 400

If pipelines are laid in such a way that axial expansion of all or individual pipe runs is no longer possible (fixed clamping of the pipeline), the calculated fixing distance must be checked for buckling safety. If the calculated guide distance is smaller than the calculated support distance, the pipeline must be supported according to the smaller value.

If axially clamped pipelines are operated at elevated temperatures or a reduction of the creep modulus due to chemical effects is to be expected, there is an increasing danger of buckling. In these cases, the determined guide distance must be reduced by 20%. The values in the table below are to be regarded as increased operating temperatures.

Material	Temperature (°C)
PE-HD	>45
PP	>60
UPVC	>40
CPVC	>80
PVDF	>100
ABS	>40

Supporting of valves

All valves, whether manual or actuated, must be adequately supported in many applications. All our valve series of VKD, VKR, TKD, etc are therefore provided with an integrated bracket that permits direct anchoring of the valve body without the need of other components.

The special integrated bracket on our VKD valve can be seen in the picture below.

For wall installation, dedicated PMKD mounting plates which are available as accessories can be used. These plates should be fastened to the valve before wall installation. PMKD plates also allow VKD valve alignment with FIP GOEMA pipe clips as well as allowing different sizes of valves to be aligned.



3.2.4 Underground installation (Buried System)

All buried piping systems are subjected to both internal and external loads. Internal loading is related to the requirements of the medium being carried and the material properties of the pipe. For external loads, thermoplastic pipes are considered flexible (able to bend without breaking) and uses the pipe wall and the surrounding soil medium to support external loads. In other words, the soil and pipe form an integral structure. Depending on the loading characteristics, the pipe will either deflect or compress. The external loads that need to be determined are, static and dynamic.

Requirements on underground engineering

Laying underground pipelines made of thermoplastic materials, in particular those with operating temperatures higher than 40°C, requires the use of an underground engineering procedure that is adapted to the material and the load.

An important factor for the operational safety of plastic pipelines is the comprehensive compatibility of the construction work with the assumptions calculated during mathematical analyses, which apply to the embedment zone in particular. Complying with the specified degree of compaction in the embedment zone is an essential prerequisite for the formation of a pipe-base support system when using flexible pipes, which is true of thermoplastics.

The following principles for underground pipe installation should be considered as a supplement to the general regulations.

Pipe trenches

Pipe trenches must be constructed in accordance with the specification of DIN EN 1610 and DIN 4124 "Excavations and trenches". The minimum trench widths, dependent on the pipe nominal width and the trench depth, are reference values that must be adapted to the installation and pipe-fitting methods. The trench width must be sufficient to permit the work required for the safe operation of the pipeline can be conducted correctly and safely.

Trench depth

Thermoplastic pipe will tend to deflect rather than crack under loading. The amount of deflection can be derived from the depth of burial, pipe stiffness and the amount of loading (e.g. soil, traffic) on the pipe. Although the maximum allowable deflection is 7.5% at a 4:1 safety factor, critical buckling occurs at 30%. For a given situation, the actual deflection and burial depth can be calculated.

For more detail regarding burial depth and estimating deflection under different conditions, consult our Aliaxis technical support.

Trench width

The construction and securing of trench, the work in the trench and its backfilling must be carried out under consideration of EN 805, DIN 4124 and DIN EN 1610 in the case of sewer trenches. In addition, the rules for industrial safety and any additional specifications of the planner must take into consideration. The trench width must correspond to the specifications in the static calculation for the pipes.

Trench Bottom

To properly support the pipe, the trench bottom should be continuous, relatively smooth, and free of rocks. Where hardpan or boulders are encountered, the trench bottom should be padded using a minimum of 100 mm of crushed rock or sand beneath the pipe. Frozen material should not be used to either support or bed the pipe.

Where the soil medium is unstable, (e.g. organic material), the trench bottom should be over excavated and brought back to grade with suitable material.

Pipe bedding

The lower bedding layer (pipe support in the pipe trench) must be flattened, compacted and levelled in accordance with the fill, and, if necessary, constructed with a specified gradient. The layer thickness must such that uneven areas in the bottom of the trench cannot under any circumstances touch the bottom of the pipeline in its installed state. If compaction of the pipe support is not carried out, the degree of compaction of the fill above it can have an adverse effect.

Placing the Pipe

The pipe and fittings should be placed into the trench using ropes and skids, slings on a backhoe bucket or by hand. Do not throw or drop the pipe or fittings into the trench, as damage may result. Particular care should be taken when handling pipe in cold weather, as the material is less impact resistant at reduced temperatures. Before assembly ensure that all materials are in good condition.

Resisting Thrust

For buried pressure pipe applications, thrust forces can occur at any point in a piping system where the directional or cross-sectional area of the waterway changes. These forces must be reduced by means of concrete thrust blocks or concrete encasement. This can be accomplished by pouring concrete into appropriately sized forms at each point in the line where thrust forces will develop. The concrete block must be placed between the fitting and the undisturbed native soil at the side of the trench.

These thrust blocks are not necessary when using fully end-load resistant pipe systems. For example, pipe systems which involves welding or electrofusion and so on.

Trench depth M	Minimum trench width (m)
< 1,00	no minimum trench width specified
≥ 1.00 till ≤ 1.75	0.80
> 1.75 till ≤ 4.00	0.90
> 4.00	1.00

Initial Backfilling

Initial backfilling is done by covering the pipe to a depth of 150 mm to 300 mm with proper backfill material that is free from rocks, sharp objects, debris or particles larger than 75 mm. Add layers in 150 mm increments ensuring that the proper compaction levels are reached for each and backfill until there is 150 mm to 300 mm of cover over the crest of the pipe. Ensure that all joints remain exposed for visual inspection. Leave the piping to settle and normalize dimensionally then check all joints for tightness. If the piping is satisfactory then tamp the initial backfill layer.

Note 1: While tamping, ensure that the pipe alignment, both vertical and horizontal, is not disturbed.

Note 2: During hot weather it is recommended that backfilling be done in the cooler morning hours when the piping is fully contracted to avoid improper compaction due to pipe expansion.

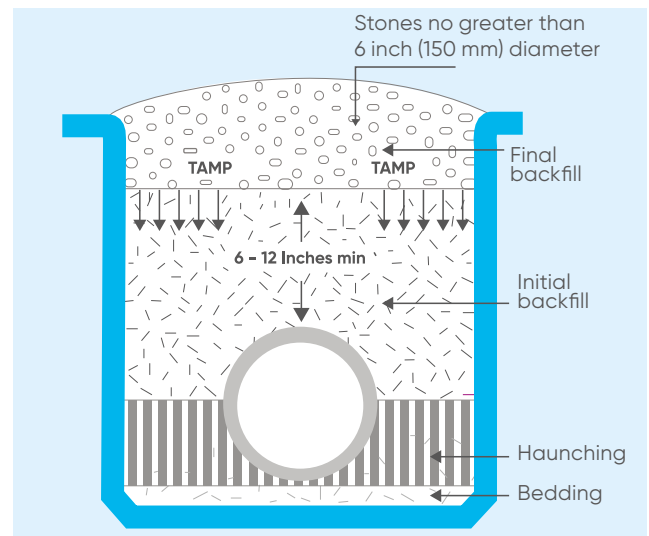

System Testing

After the system has been assembled and initially backfilled, the system must be tested for leaks. Note that the pipe must be sufficiently backfilled to prevent movement during testing.

Conduct a pressure test as per the testing procedure which is explained under pipeline testing in this manual. If the test is passed, the system can be covered. If not, make the necessary repairs and test again until the system is sound.

As a general recommendation as far as the installation of UPVC below ground is considered, the pipe should never be encased in concrete. Encasing in concrete transforms a flexible pipe into a rigid structure with no flexural strength, annihilating many benefits of plastic pipe systems.

Compacting the Final Backfill

Final backfilling is the material that is placed over the initial backfill to the top of the trench. Compact the haunching, initial backfill and final backfill using manual equipment in accordance with the job drawings. Observe the following precautions:

- when a "self-compacting" material is used, such as crushed stone, ensure that the material does not arch or bridge beneath the haunch of the pipe. Remove such voids with the tip of a spade;
- when compacting the material underneath and at either side of the pipe do not allow the tool or the machine to strike the pipe;
- when compaction in excess of 85% standard proctor density is required in the haunching area ensure that the compacting effort does not dislodge the pipe from the correct grade. If the compacting effort dislodges the pipe, re-lay the pipe to the correct grade;
- it is not necessary to compact the initial backfill directly over the top of the pipe for the sake of the pipe's structural strength. However, it may be necessary for the sake of roadway integrity;
- when laying long runs of piping in elevated air temperatures, it is advisable to begin working from a fixed point – such as the entry or exit from a building, and work away from that point, testing and backfilling in accordance with preceding paragraphs. This procedure should then allow the piping to assume soil temperature progressively as work proceeds.

The bedding of the plastic pipeline directly on the trench bottom is only permitted if fine-grained sandy soil is found and an even bearing is ensured along the entire pipe route. The installation of plastic pipelines with special properties (e.g. with reduced crack sensitivity or additional protective layers) is determined by the respective system manufacturer's regulations.

The thickness of the standard bedding layer must be ≥ 10 cm in a compacted state. For rocky or firm trench bottoms, the bedding layer thickness must be increased to ≥ 15 cm. Before and during pipeline installation, the bedding layer must be checked to ensure it is free of stones.

Loads on underground pipelines

When dimensioning underground plastic pipelines, a distinction must be made between internal loads (caused during operation) and external loads (originating from the installation environment). An overall analysis must take into account the mechanical, thermal and chemical load of the pipe system. If applicable, when making mathematical considerations, the loads occurring in the construction and test state should be assessed.

The more accurate the assumed loads are, the safer and more economical the dimensioning of the pipeline. This applies particularly to pipe components made of plastic. Rough or vague data results in adverse load combinations being used for the calculation, which can lead to oversizing. Another possibility is that if a load size is not accurately reproduced, the stability of the plastic pipeline can be compromised.

The load components in an underground plastic pipeline can occur both individually and jointly, and they can have short-term or long-term effects. Usually it is a mixture of loads, where a load is permanently applied, and this, together with recurrent additional loads, must be considered superficially.

The table below which is according to DVS 2210-3 shows which loads must be taken into account during the planning and dimensioning of underground plastic pipelines.

Load overview, variables and effects

Type of load	Variables and effects
Earth and traffic loads	Dependent on the installation depth above the top of the pipe
Deadweights and filling weights	Smaller influence than for pipe systems routed above ground
Groundwater load	Dependent on the groundwater level above the pipe bottom
Mechanical loads caused by incorrect pipe installation in the embedment zone (e.g. caused by stones, squared timbers, foreign bodies, etc.)	Associated with localized deformation of the pipe and risk of cracking, dependent on the material structure
Overpressure or negative pressure load	General load caused by the pipeline's operation
Thermal stress	Associated with thermal stresses, when the operating temperature TB is $> 20^{\circ}\text{C}$ and is subject to significant fluctuations
Load from the transported medium	Some transported media can cause changes to the material properties of plastics (e.g. reduction in strength due to effect of solvents).

Earth and traffic loads

Earth, traffic and surface loads above the top of the pipe generate flexural and compressive stresses in the pipe wall. A distinction must be made as to whether these are short-term (e.g. in the stage of construction) or have lasting effects.

Furthermore, the circular pipe cross-section as it was during installation will be permanently deformed by the applied loads. The size of the stresses and deformations depends on the quality of the excavation work when installing the pipeline within the embedment zone.

In general, the lower the supporting effect of the surrounding soil is, the greater the stress and deformation in the pipe cross-section. As a result, particular importance is attached to the correct installation.

Groundwater loads

In addition to the loads mentioned above, another variable is the influence of groundwater. Provided that the groundwater level can rise above the bottom of the pipe, its effect must be examined in the form of a stability calculation. The pipeline must be equipped with sufficient buckling resistance to the external over pressure (superposition of earth, traffic and surface loads and ground water influence).

Operational loads

Operational loads can arise both from internal over pressure or negative pressure, and the temperature and type of the transported medium. Exogenous earth and traffic loads and the operating pressure load present inside the pipe must be superposed as part of the structural calculations (effect of superposition).

The positive operating pressures listed in the pipe basic standards, dependent on the operating temperature and operating time, provide information about the internal pressure load capacity of the plastic pipeline. When dimensioning, it is important to take into account any single pipework element's MOP, which can differ between pipes and segmented shapes.

In the case of molded components that are made of pipe (segment elbows, branches with welded inlet connections), a reduction in the internal pressure load capacity indicated in the basic standards is caused as a result of process-related and/or geometric influences.

Another significant reduction in the internal pressure load capacity of plastic pipelines in relation to the data in the pipe basic standards is a result of the influences of the transported medium on the creep behaviour of the respective plastic.

3.3 Pipeline testing on-site

Pressure testing is the test carried out after the installation of any pipeline before it is put into use.

The purpose of the pressure testing is to investigate the various limits of the pipeline, to understand its reliability, maximum capacity, leaks, joint fittings and pressure, otherwise the pipe cannot be put into service.

Therefore, information found from pressure testing aids to maintain the safety standards and the upkeep of the pipeline.

General recommendations are grouped under the following headings:

- preparation for test;
- test pressures;
- applying the test;
- interpretation of results.

Preparation for test

- 1) Pipe systems should be hydraulically tested in lengths appropriate to the diameter and site conditions.
- 2) Preferably, the test should be carried out between blank flanges. The ends of the pipeline to be tested can be adapted by the use of appropriate flanged sockets or bolted flange adaptors.

The blank ends should be drilled and tapped as necessary to accommodate the necessary inlet and outlet connections.

The ends of the main pipeline, and all branch connections, should be strutted and anchored so as to adequately withstand the thrusts from the test pressures.

- 3) The anchor jacks or struts should be of adequate strength and properly aligned.

Typical layouts for pressure tests are illustrated in the following picture.

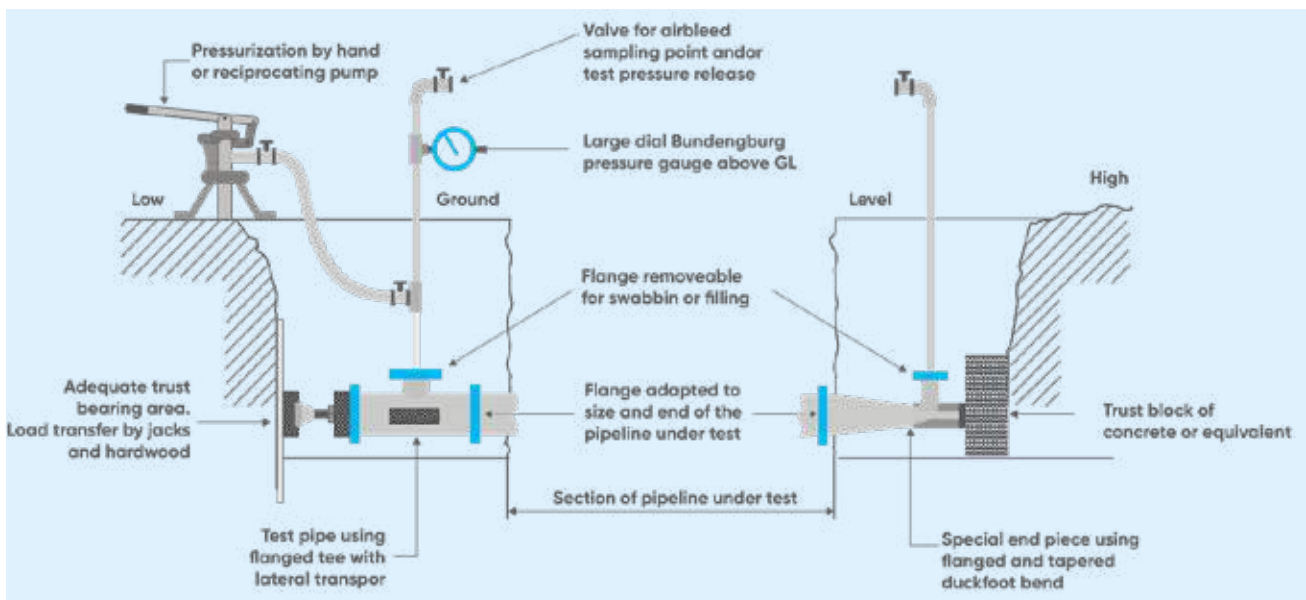

- 4) Testing should not take place until any concrete used for anchorage has matured and attained its required strength. Solvent welded joints should be allowed to harden for a minimum of 24 hours before being subjected to test conditions.

- 5) Site conditions will usually dictate whether all joints can be left exposed. Whenever practicable, joints should be exposed throughout the test period.

It is important to provide sufficient compacted surround and backfill, over the main barrel of the pipe, to prevent displacement and to maintain stable temperatures during the test period.

6) Wherever possible, the test position should be located at the lowest point of the pipeline profile to encourage the expulsion of air as the pipe is being filled.

This position will usually register the maximum pressure head and enable easier control over the release of any test water. Adequate air release mechanisms should be sited at all high points along the pipeline.

7) Test-ends should be designed to enable the measured filling and subsequent emptying of the pipeline. Blank flanges, test pipes or end caps should have the relevant tappings to accommodate the necessary pressure gauges and related equipment.

An air bleed should also be incorporated at each end of the test section.

8) The pressurizing equipment, whether hand or mechanically operated, should be adequately sized and sufficiently robust, with connections of suitable design to positively impose and maintain the required test pressures.

All seals and any non-return valve mechanisms should be checked prior to the test.

Automatic pressure recording equipment is recommended to be used.

9) Before filling the pipeline, all line valves and air venting systems should be checked open.

Every attempt should be made to remove all air from the main.

Introduction of a firm foam swab ahead of the water column will prove helpful in some cases.

This procedure is shown diagrammatically in the following picture.

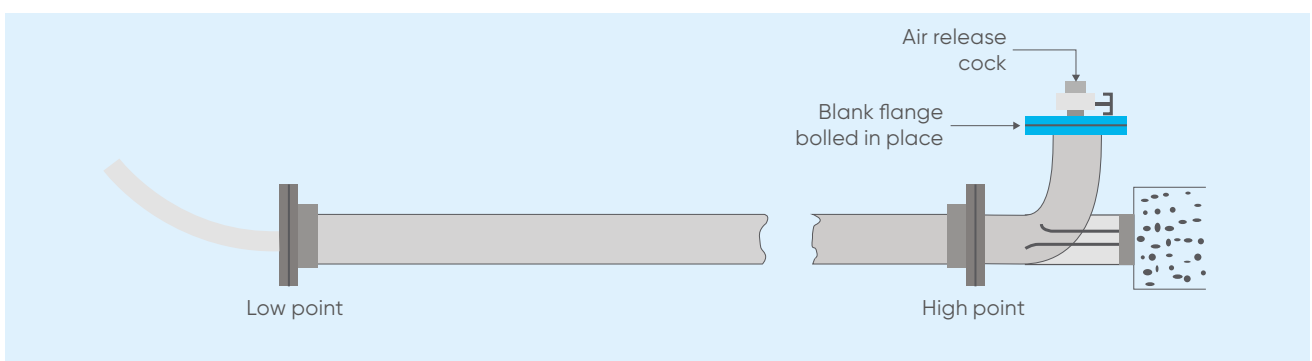
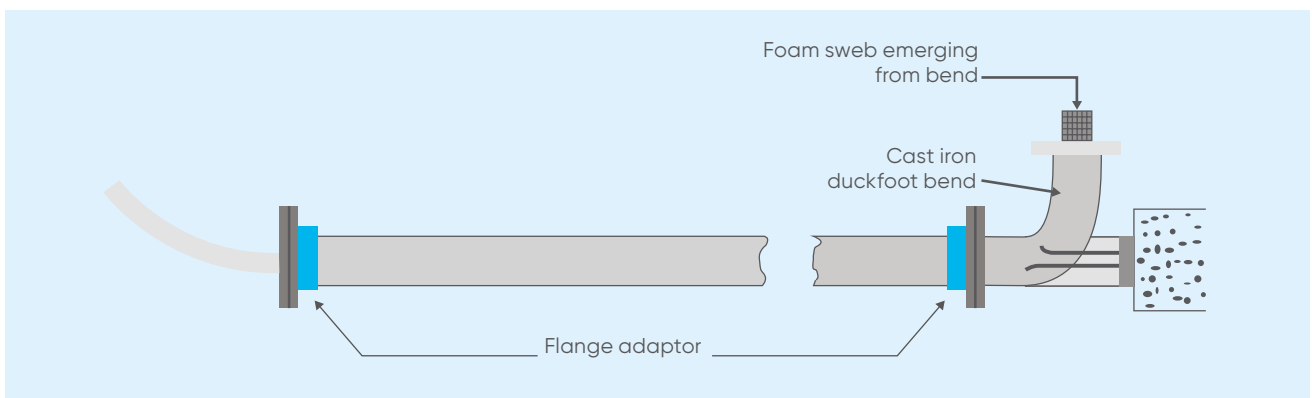
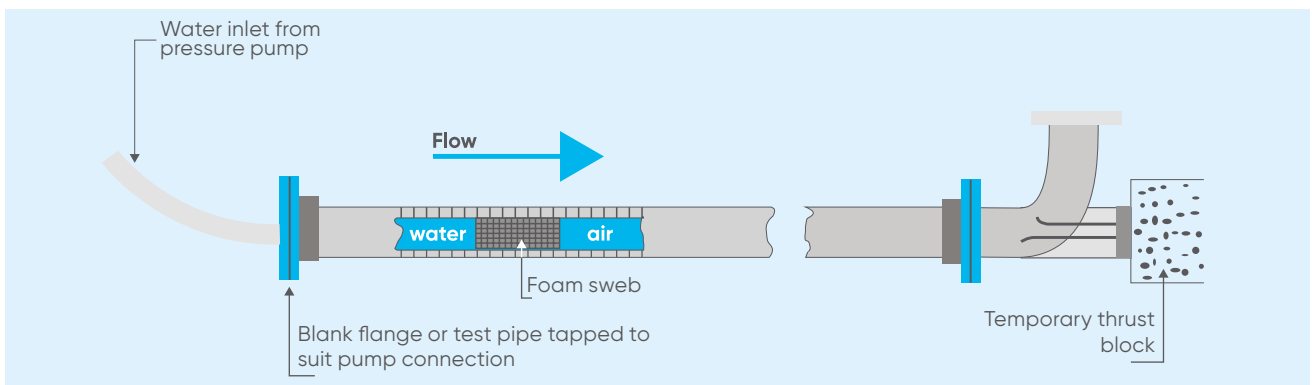

10) When the system is to be used for potable water, then the test medium should be potable water.

It is important to charge any pipeline slowly, the rate of fill being governed by the facilities available for the air to discharge at an equal volumetric rate.

After ensuring the pipeline is fully charged, all air vents should be closed.

Automatic air valves will self-seal under pressure but their action and seating should be checked as part of the test.

11) During the filling and pressurizing process, a number of minor movements can be expected in the pipeline between anchorage points because of one or more of the following:

- additional weight of the pipe as it fills, causing slight adjustment in the soil/pipe interface;
- minor dimensional changes and a tendency of the pipeline to straighten under pressurization;
- thermal movement due to temperature differences at the water/pipe/soil interfaces.

12) The whole pipeline should, therefore, be left under a nominal or service pressure to stabilize for a period of time.

A minimum of 2 hours to 3 hours should be allowed for even the smallest pipeline.

Test pressures

The hydrostatic test should conform to the following conditions:

- be carried out at ambient temperature;
- be applied for at least 1 hour, but not more than 24 hours;
- not exceed 1,5 times the maximum rated pressure of the lowest rated component.

This last recommendation is interpreted in a variety of ways, in fact test pressure requirements range from the severe 1,5 times pipe nominal pressure PN, to 1,5 times the actual operating pressure, so the continuous pressure, which is sustained in the system without surge.

Therefore, the recommended test pressure to be applied should be the greater of:

- the nominal pressure PN of the piping system (lowest PN of any component)
- 1,5 times the actual operating pressure (should not exceed the nominal pressure PN plus 5 bar)

Applying the test

Before starting with the internal pressure test, the following points must be checked:

- Was installation done according to the available plans?
- All pressure relief devices and flap traps mounted in the flow direction?
- All end valves shut?
- Valves in front of other devices are shut to protect against pressure?
- Visual inspection of all joints, pumps, measurement devices and tanks?
- Has the waiting period after the last welding/cementing been observed?

After sufficient time has been allowed for the main to stabilize, the pressure test may then be steadily applied and the pipeline can be filled from the geodetic lowest point according to these steps:

1) Pressurizing can be either by hand or motorized pump, pressure gauges should be observed throughout and the rate of pressure increase recorded.

2) The pressure should be increased until the specified test pressure is reached at the lowest part of the section.

The pressure is maintained at this level, by additional pumping if necessary, for a period of 1 hour.

All valves are then closed and the pressurising unit disconnected. No further water should be allowed to enter the section under test for a further period of 1 hour.

3) The following measurement values must be recorded consistently during testing:

- internal pressure at the absolute lowest point of the pipeline;
- medium and ambient temperature;
- water volume input;
- water volume output;
- pressure drop rates;
- visual examination of joints and connections of the section under test.

Interpretation of results

1) If there has been a decrease in pressure during this period, the original test pressure is re-established by injecting a measured quantity of water into the test section.

2) The test may be considered satisfactory if:

- there is no decrease in pressure (it is even possible for there to be a slight rise due to changes in temperature or material reversion);
- the measured quantity of water required to reinstate the pressure to the original test pressure is less than a "permissible maximum".

3) On completion of any test, the residual pressure should be released slowly and in a carefully controlled manner.

4) All defects revealed by the test should be rectified and the procedure repeated until a satisfactory result is obtained.

Note: The "permissible maximum" value of water and the method of calculation vary considerably from country to country: users' requirements should therefore be obtained and applied as appropriate.

The volume of water added is an allowance made to compensate for the natural expansion and movement of the pipe and flexible joints under pressure and for the inevitable entrapment of small amounts of air within the test length.



WARNINGS

- Pressure tests should never be carried out using compressed air as the testing.
- The rapid decompression of any entrained air can cause surge conditions, which are potentially dangerous both to the pipeline and to personnel.
- If a ball valve is used, the pipeline test must be carried out only if the valve is closed and assembled correctly, complete with all its elements, ring nut and sleeve included. This is critical to avoid valve breakage or deformation due to pressure.

The same recommendation about a correct assembly has to be followed if the ball valve is located at the end of a pipe in an already working pipeline system.

3.4 Storage, Transportation and Handling

Components for industrial thermoplastic piping are designed and produced for use in heavy duty systems involving the transport of aggressive liquids. In order to ensure their integrity once installed, they must be handled prior to installation with reasonable care.

Field Storage

Although plastic materials have excellent resistance to weathering, it is recommended that prolonged storage be under cover as to maintain their installation suitability and provide an adequate protection against UV radiation.

In addition to above it is important to avoid storage in an open field with environmental temperature below 0 °C and takes care to do not exceed storage temperature over the maximum temperature admitted by material (please refer to material properties reported in this manual and on our Aliaxis product catalogues).

The products have to be kept in their original pack until the installation.

Bundled pipe may be double-stacked providing its weight is distributed by its packaging boards.

Handling

As far as handling is considered, care should be exercised to avoid rough handling of pipe, fittings and valves.

All sharp edges on a carrier or trailer that could come in contact with the pipe should be padded.

Only nylon or rope slings should adopted for lifting bundles of pipe, chains have not to be used.

Transportation

In order to avoid bending, sagging or stress, care must be taken when transporting plastic pipes to ensure that the pipes are fully supported during movement. Vehicles should be capable of supporting the entire pipe length. An overhang not supported shall not exceed 1 m. Any surfaces that may be in contact with material should be free of nails or sharp edges. Where side supports are used, they should be smooth, free from sharp edges, and at centers of not more than 1.5 m. Pipes should always be loaded with the heaviest at the bottom.

The picture below an example to distinguish both the correct way of pipe storage

To sum it up, the following guidelines should always be followed:

- pipelines should be supported during transportation and storage along their length;
- nails, rough edges or stones should be avoided in loading and storage areas;
- throwing or dropping of pipes from vehicle should be avoided;
- never drag pipelines over the ground;
- pipes should not be stacked excessively high;
- safeguard pipes from direct sunlight;
- ensure that the pipes stored do not come into contact with inappropriate chemicals or oils;
- special attention should be given when handling pipes in cold weather conditions;
- inspect all pipes prior to usage and avoid any damaged, gouged or badly scratched pipes.

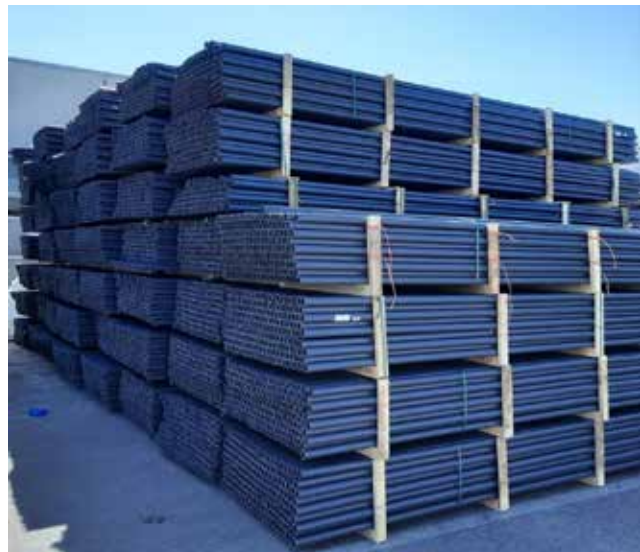

FIP UPVC pressure pipe ready on stock for the loading.





4. System and product solutions	291
4.1 Solvent welded UPVC systems	292
4.2 Solvent welded FIP CPVC systems	294
4.3 Solvent welded SuperFlo ABS systems	296
4.4 Welded FIP PP systems	298
4.5 Welded PE systems	300
4.6 Welded FIP PVDF systems	302
4.7 Double containment	304
4.8 Compressed air	306
4.9 Fuel system PLX	308
4.10 Vulcathene	310
4.11 Straub mechanical joints	312
4.12 FIP Silicone free system	314
4.13 FLS	315



4. System and Product Solutions

As a global leader in advanced plastic piping solutions, Aliaxis intervenes at many stages in the transport of water from its source to delivery to the end-user. Our brands have been providing innovative solutions for over 60 years and represent our history and our know-how in the field of building, infrastructure and industry. For each of these segments, we offer a comprehensive range of high-quality products, tailored to our customer's needs. We offer systems that convey water, chemicals and gases to conduits that carry power and data cabling to digital flow measurement system. From valves and fittings to pipes. From solvent cement and cutting tools to electrofusion systems. Whatever the product or application, our customers can be confident that everything they need for their particular solution will be delivered with the quality and service expected from an industry leader.

Our industrial system solutions are focused on approved raw materials, covering all the criteria of the most relevant international norms and in full compliance with existing environmental regulations. A huge network of distributors, structured to guarantee not only the availability of products but also direct support and advice, is one of many advantages that Aliaxis provides to its customers.



4.1 Solvent welded UPVC systems

The different formulations obtained by adding suitable additives and stabilizers make UPVC the most versatile of all plastic materials, allowing it to be adapted to many applications involving fluids under pressure.

In the field of thermoplastic and metal products, UPVC is one of the most economical options for addressing problems in the transport of corrosive chemical fluids and the distribution and treatment of water in general.

The piping system made of UPVC material is well suitable for operating temperatures in the range of 0 °C to +60 °C.

The UPVC System is available in different portfolio and brands with the target to meet all the customer needs in many different subsegments.

Our FIP UPVC portfolio, reported in picture below, offer a comprehensive system leveraged by innovative valves, a wide range of fittings and high-quality pipes for any industrial and process application.



4.2 Solvent welded FIP CPVC System

In 1986, FIP was the first European Company to produce an integrated system of valves, fittings and pipes. The result was the creation of an entire series of products for industrial plants.

The FIP CPVC system represents one of the most economical solutions in the field of thermoplastic materials, able to solve the difficulties encountered in process and service lines transporting hot corrosive fluids in the industrial sector, as well as in domestic hot and cold-water distribution systems.

Currently, in Aliaxis, we offer high level CPVC products in our FIPindustrial brand.

CPVC resins are specifically designed for industrial applications and are fully compatible for use in transporting water and treatment plants, as well as for conveying demineralised water and SPA water.

The piping system made of CPVC material is well suitable for operating temperatures in the range of 0 °C to +95 °C.

Typical applications

- Industrial water treatment plants.
- Chemical process industry.
- Surface treatment industry.
- Hot and cold water distribution.
- Swimming pools and SPA.



Technical data

Nominal pressure	Up to 16 bar
Temperature range	0 °C to 95 °C
Size range	16 mm to 315 mm
Jointing technology	Solvent cement jointing, threaded joint, flanged joint
Standards and guidelines *	ANSI B16.5, ASTM D1784 cl. min 23447, ASTM F437, ASTM F439, ASTM F441, DIN 2501, DIN 8079-8080, EN 558-1, EN 1092-1, EN 10226-1, EN 10226-2, EN 14728, EN ISO 15493, ISO 228-1, ISO 7005-1, ISO 9624, ISO 5211, JIS B 2220, UNI 11242
Approvals	ABS, ACS, BUREAU VERITAS, DNV-GL, EAC, LR - Lloyd's Register, KR - Korean Register, NSF, TA-Luft, UKR SEPRO, WRAS, RMRS

*This table shows the main standards and guidelines of the system, there could be other local standards that are not listed here but which are still in force.

CPVC product overview

De	16	20	25	32	40	50	63	75	90	110	125	140	160	180	200	225	250	280	315	355	400	
DN	10	15	20	25	32	40	50	65	80	100	125	125	150	150	200	200	250	250	300	350	400	
Inches	3/8"	1/2"	3/4"	1"	1 1/4"	1 1/2"	2"	2 1/2"	3"	4"	5"	5"	6"	6"	8"	8"	10"	10"	12"	14"	16"	
Pipes	•	•	•	•	•	•	•	•	•	•	•	•	•	•	•	•						
Fittings																						
Solvent welded fittings	•	•	•	•	•	•	•	•	•	•	•	•	•	•	•	•						
Adaptor fitting	•	•	•	•	•	•	•															
Valves																						
2-way ball valve	•	•	•	•	•	•	•	•	•	•												
3-way ball valve	•	•	•	•	•	•	•															
Diaphragm valves		•	•	•	•	•	•	•	•	•												
Butterfly valve						•	•	•	•	•	•	•	•	•	•	•	•	•	•	•	•	•
Sediment strainer		•	•	•	•	•	•															
Check valves	•	•	•	•	•	•	•	•	•	•	•	•	•	•	•	•	•	•	•	•	•	•
Flanges and gaskets																						
	•	•	•	•	•	•	•	•	•	•	•	•	•	•	•	•	•					

4.3 Solvent welded SuperFlo ABS System

SuperFlo ABS is a solvent welded, fully matched pipework system incorporating pipe, fittings and valves that is available in both imperial and metric sizes.

SuperFlo ABS provides a wide temperature range and the system remains extremely ductile even at temperatures as low as -40°C , which make it the ideal solution when there is a requirement for a pipe system to transport low temperature fluids at pressure.

Furthermore, SuperFlo ABS is extremely lightweight and is much easier to handle on-site than traditional materials especially during installation which can significantly reduce both time and cost, as well as being fully WRAS approved.

The piping system made of SuperFlo ABS is well suitable for operating temperatures in the range of -40°C to $+60^{\circ}\text{C}$.

Typical applications

- Chilled water.
- Food and beverage.
- Potable water.
- Low temperature cooling.
- Demineralized water.
- Vacuum systems.
- Wastewater.



Technical data

Nominal pressure (imperial)	Class E (up to 4"), Class D (up to 6"), Class C (up to 8")
Nominal pressure (metric)	10 bar (16 to 250mm), 8 bar (250 to 315mm)
Temperature range	-40°C to 60°C
Size range (imperial)	1/2" to 12"
Size range (metric)	16 mm to 315 mm
Jointing technology	Solvent cement jointing, threaded jointing, flanged jointing
Standards and guidelines*	BS EN 1452, ASTM D638, EN ISO 1183-1, ISO 527
Approvals	ABS, BUREAU VERITAS, DNV, FDA, GL – Germanischer Lloyd, LR – Lloyd's Register, REG 31, WRAS

*This table shows the main standards and guidelines of the system, there could be other local standards that are not listed here but which are still in force.

4.4 Welded systems FIP PP System

Thanks to the exceptional chemical and thermal properties of the resin, our polypropylene system provides excellent performance at high working temperatures. Our system made of polypropylene is manufactured by FIP and it consists of a comprehensive range of pipes, fittings and valves for use in the construction of process and service lines for conveying pressurized industrial fluids.

The piping system made of polypropylene material is well suitable for operating temperatures in the range of 0 °C to +95 °C.

Typical applications

- Industrial water and wastewater treatment plants.
- Chemical process industry.
- Industrial surface treatment.
- Demineralized and SPA water distribution.



Technical data	
Nominal pressure	Up to 10 bar
Temperature range	0 °C to 95 °C
Size range	16 mm to 800 mm
Joining technology	Butt, socket and electrofusion jointing
Standards and guidelines *	ANSI B16.5 cl. 150, ASTM D 4101-06, BS 10, DIN 2501, DIN 8077, DIN 8078, DVS 2202-1, DVS 2207-11, DVS 2208-1, EN 558-1, EN 1092-1, EN 10226-1, EN 10226-2, EN 14728, EN ISO 15494, ISO 228-1, ISO 5211, ISO 7005-1, ISO 9624, JIS B 2220, UNI 11318, UNI 11397
Approvals	DIBt, EAC, RINA, TA-Luft, UKR SEPRO, NIZP

*This table shows the main standards and guidelines of the system, there could be other local standards that are not listed here but which are still in force.

4.5 Welded systems PE System

Our piping system made of polyethylene is used since decades in areas of application where the pipe system has to meet high standards of durability and reliability. These standards are met by combining the excellent material properties of PE and the experience in manufacturing injection molded, extruded and fabricated plastic components.

Our polyethylene systems are composed by top quality FIP spigot fittings, flanges and adaptors and the exceptional range of Frialen electrofusion fittings.

These systems are ideal for applications in all areas of industrial plant engineering. Further domains are the transport of industrial and domestic water, wastewater treatment and water purification as well as various applications in marine or swimming pools.

The piping system made of polyethylene material is well suitable for operating temperatures in the range of $-40\text{ }^{\circ}\text{C}$ to $+60\text{ }^{\circ}\text{C}$.

Typical applications

- Municipal and Industrial water and wastewater treatment plants.
- Process and cooling water.
- Chemical process industry.
- Swimming pools.
- Sewage plants.
- Water and gas distribution.



Technical data

Nominal pressure	Up to 16 bar
Temperature range	$-40\text{ }^{\circ}\text{C}$ to $60\text{ }^{\circ}\text{C}$
Size range	20 mm to >800 mm
Joining technology	Butt and electrofusion jointing
Standards and guidelines *	DIN 2501, DVS 2202-1, DVS 2207-1, DVS 2208-1, EN 1092-1, EN 1555, EN 13244, EN ISO 15494, ISO 7005-1, ISO 9624, ISO 27, ISO 4437, ISO 21307, UNI 10520
Approvals	DVGW, RINA, KIWA, KTW

*This table shows the main standards and guidelines of the system, there could be other local standards that are not listed here but which are still in force.

4.6 Welded systems PVDF System

The FIP PVDF system is the best alternative to metal materials due to its high purity and exceptional chemical and mechanical performances over a wide range of temperature.

It is extensively used in industrial applications such as chemical, oil, pharmaceutical, pulp and paper electronic operations.

The FIP PVDF system is well suitable for operating temperatures in the range of $-40\text{ }^{\circ}\text{C}$ to $+140\text{ }^{\circ}\text{C}$.

Typical applications

- Chemical processing industries.
- Surface treatment.
- Microelectronics.
- Oil and gas industry.
- Pharmaceutical.
- Pulp and Paper.



Technical data

Nominal pressure	Up to 16 bar
Temperature range	$-40\text{ }^{\circ}\text{C}$ to $140\text{ }^{\circ}\text{C}$
Size range	16 mm to 400 mm
Joining technology	Butt and socket welding
Standards and guidelines *	ANSI B16.5, ASTM D3222, DIN 2501, DVS 2202-1, DVS 2207-15, DVS 2208-1, EN 558-1, EN 1092-1, EN ISO 10931, EN 14728, ISO 5211, ISO 7005-1, ISO 9624
Approvals	DIBt, DVGW KTW, W270, EAC, FDA, NSF, TA-Luft, UKR SEPRO, WRAS

*This table shows the main standards and guidelines of the system, there could be other local standards that are not listed here but which are still in force.

4.7 Double containment

Double containment piping systems are ideal solutions where there is a need for high safety. For example, transportation of corrosive, hazardous, or toxic media always poses a huge risk factor to the human and to the environment. In those applications, double containment piping systems play an inevitable role.

The double containment system consists of two pipes, one of smaller diameter inside another of greater diameter: the fluid is carried through the inner pipe, the outer pipe ensures extra protection if the inner pipe spills. There are distinct approaches used for leak detection, for example a leak monitoring system is usually applied by end-users to warn operators that a leak has occurred.

In various applications, these solutions can be used, mainly for the treatment of chemical and effluent water transfers. According to the designated use, inner and outer pipe can be made of the same or a combination of different pipe materials.

A - Outer pipe

Double wall system to protect the environment from fluid leakage or to protect the fluid from external influences.

B - Inner pipe

Fluid conveyance and resistance to pressure.

C. - Annulus space

Space between pipes to contain leakage fluid, or to be equipped with insulation, leakage detection or heating wires.



Technical data

Nominal pressure	Pressure less drainage systems - Pressurized systems up to 16 bar
Temperature range	-40 °C to 140 °C
Size range inner pipe	Up to 800 mm
Joining technology	Butt, socket welding and electrofusion

Double containment product overview

Aliaxis offers a wide variety of double containment UPVC, PP AND PE solutions for many purposes, whether it is chemical drainage from laboratories or insulated pipes for greasy fluids, potable water protection pipes in contaminated land. Any of these systems is specifically designed to perfectly suit the dedicated needs at a minimum cost of installation and total ownership.

To get more information, please contact your Aliaxis sales representatives.

Typical applications

- Water and wastewater treatment.
- Conveyance of hazardous liquids.
- Environmental protection.
- Protection of sensitive premise.
- Drainage applications.
- Conveyance of chemical waste from laboratories.

4.8 Compressed air GIRAIR®

Compressed air, a major source of industrial energy, is being used increasingly in both the manufacturing and processing industries. There, its distinct advantages of cleanliness, flexibility, safety and economy of use compared with other energy sources are fully exploited.

The cost of compressed air network chiefly depends on its energy consumption . Each leak on your system puts an extra burden on your energy bill.

For extra safety and peace of mind, the owners of an installation should therefore select a compressed air distribution system that can resist the numerous aggressions coming from its environment.

In Aliaxis, we offer two solutions for compressed air distribution each made of different materials:

- GIRAIR UPVC.
- Air-Line Xtra ABS.

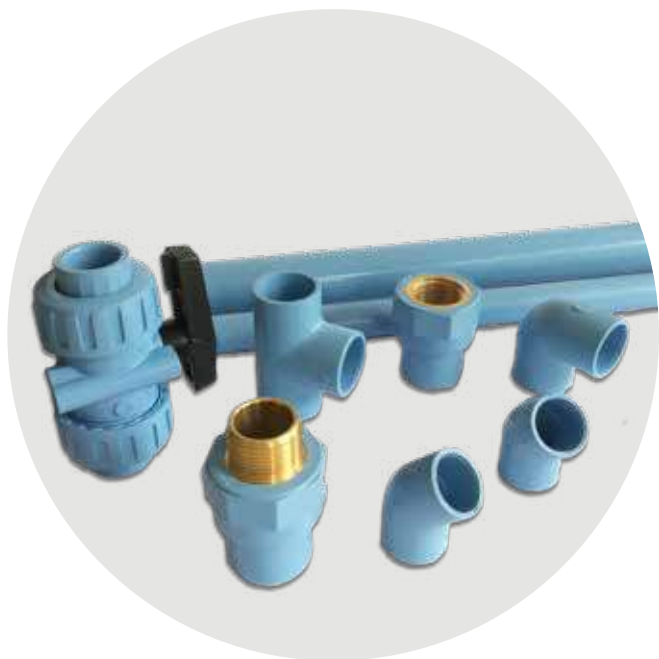

Typical applications

- Compressed air distribution.
- Neutral gas distribution.
- Centralized networks.
- Food and beverage – CO₂ delivery.
- Ventilation.
- Valve actuation.
- Plant Air.
- Pneumatic machinery.

Technical data

Nominal pressure	Up to 12.5 bar
Temperature range	-20 °C to 50 °C
Size range	16 to 110 mm
Joining technology	Solvent jointing and threaded jointing
Standards and guidelines*	BS 4800, BS 1710, DIN 8062-8063, ISO 11359, EN ISO 1183-1, EN ISO13846, EN 13501-1, NF EN 921, NF EN 1452, NF T54-038
Approvals	BSI, Bureau Veritas, DNV, LNE fire certificate, National Accreditation of Certification Bodies

*This table shows the main standards and guidelines of the system, there could be other local standards that are not listed here but which are still in force.

Compressed air system product overview

De	16	20	25	32	40	50	63	75	90	110
DN	10	15	20	25	32	40	50	65	80	100
Inches	3/8"	1/2"	3/4"	1"	1 1/4"	1 1/2"	2"	2 1/2"	3"	4"
Pipes	•	•	•	•	•	•	•	•	•	•
Fittings										
Solvent welded fittings	•	•	•	•	•	•	•	•	•	•
Threaded fittings	•	•	•	•	•	•	•			
Adaptor fittings	•	•	•	•	•	•	•			
Valves										
	•	•	•	•	•	•	•	•	•	•
Flanges and gaskets										
				•	•	•	•	•	•	•

4.10 Vulcathene **Vulcathene**

Vulcathene is a purpose-designed and engineered laboratory drainage system that has been specified and installed as a safe solution for transporting chemical waste from the laboratories of schools, universities, hospitals, research facilities and industrial environments worldwide for more than 65 years.

The only system BBA approved for laboratory drainage, Vulcathene offers the widest range of bench items including sinks, drip cups and anti-siphon and dilution recovery traps to enable the design and specification of a complete chemical drainage laboratory system.

The choice of two easy jointing methods, mechanical for demountable joints and electrofusion for welded joints, allows flexibility in design, installation efficiencies and ease of system extensions and maintenance.

Typical applications

Vulcathene products are used in all those applications that need to transport chemical waste, for example:

- Laboratories in Schools.
- Laboratories in universities and colleges.
- Hospitals and clinics.
- Pharmaceutical companies.
- Research organizations.



Technical data

Size range	38 up to 152 mm
Temperature range	-20 °C to 100 °C (Only intermittent at 100°C)
Standards and guidelines	BS1710
Approvals	BBA

Vulcathene product overview

De	48.3	60.3	89	114.3	168.3
DN	38	51	76	102	152
Inches	1 1/2"	2"	3"	4"	6"
Pipes	•	•	•	•	•
Fittings					
Mechanical fittings	•	•	•	•	
Electrofusion fittings	•	•	•	•	•

4.11 Mechanical joint Straub

The quick, easy and reliable Straub mechanical joint is an alternative to welding or flange connections. The original STRAUB coupling revolutionized pipe connection technology since it is a universal pipe connection that can be applied very easily and quickly.

STRAUB couplings are available in various sizes and in different varieties. The most appropriate coupling can be chosen based on the application.

Typical applications

- Water and wastewater utilities.
- Hydropower.
- Groundwork and industry.
- Shipbuilding and offshore.



Technical data

Nominal pressure	Up to PN16 (marine rating)
Size range	21 up to 4064 mm
Temperature range	-20 °C to 100 °C
Standards and guidelines*	DIN 8074, EN 1254-3, ISO 19921, ISO 19922
Approvals	ABS, BUREAU VERITAS, DNV-GL, KR – Korean Register, LR – Lloyd's Register, NSF, VdS, WRc

*This table shows the main standards and guidelines of the system, there could be other local standards that are not listed here but which are still in force.

STRAUB product overview

De	21.3	30	38	40	48.3	63	168.3	180	219	355	609.6	711.2	2032	4064
Restrained														
METAL-GRIP (Connection of metal pipes and rigid plastics)		•	•	•	•	•	•	•	•	•	•			
GRIP (Connection of metal pipes and rigid plastics)	•	•	•	•	•	•	•							
GRIP-L (Connection of metal pipes and rigid plastics)								•	•	•	•	•		
COMBI-GRIP (Metal to plastic pipe connection)			•	•	•	•	•	•	•	•				
PLAST-GRIP (Connection of plastic pipes)				•	•	•	•	•	•	•				
PLAST-PRO (Connection of plastic pipes)						•	•	•	•	•				
Flexible														
FLEX (Connection of same or different pipe materials)					•	•	•	•	•	•	•	•	•	•
OPEN-FLEX (Connecting pipes or repairs without removal of existing pipes)					•	•	•	•	•	•	•	•	•	•
STEP-FLEX (Connection of pipes having different external diameters)									•	•	•	•	•	

4.12 FIP Silicone Free System

Silicone is present in a large number of widely used industrial products such as oils and lubricants.

Products based on silicone are relatively chemically inert: this means a great attention of the customers to avoid upstream contamination with the use of products without silicone.

The concerned industries are those where surface treatments or other operations including the use of inks or paints are performed, most notably the automotive sector.

A strong focus is applied in the production sites where such operations are performed to install and use only components guaranteed to be free from traces of silicone.

Aliaxis meets this need with a clean room classified as ISO 5 (Class 100) level according to ISO 14644-1. FIP manual valves, variable area flowmeters and the whole range of fittings in plastic materials, up to diameter of 160 mm, can be processed in the clean room and supplied as silicone free.

The range of ball valves for industrial applications can also be provided silicone and lubricants free as valves are assembled without any lubricant.

Typical applications

- Automotive.
- Metal surface treatment.
- Pharmaceutical.
- Food and beverage.
- Household appliances.



Technical data

Nominal pressure	Up to 16 bar
Size range	16 mm to 160 mm
Standards and guidelines	ISO 14644-1

4.13 FLS

Aliaxis offers a complete range of products identified by FLS brand, which are designed to provide accurate and reliable data to support smooth operations by enabling live process control and predictive maintenance.

FLS devices are used for a wide variety of processes and applications concerning the measurement of flow rate, pH, conductivity and redox potential.

These solutions offer several advantages, both general and specific, such as flexibility of installation, ease of commissioning and maintenance.



Typical applications

FLS products are used in all those applications that require flow measurement or characteristics of the liquid, for example:

- Water treatment systems.
- Industrial wastewater treatment and recovery .
- Swimming pools and SPA.
- Chemical industry.
- Surface treatment.
- Mining and hydrometallurgy.
- Irrigation and fertigation.
- Leak detection.

The following tables describe the main technical data of the instruments for measuring flowrate, pH, redox potential and conductivity: this can help to have a first quick identification of the devices contained in the FLS range.

In particular, for each type of measurement to be carried out, the following table lists the most suitable instrument, the minimum and maximum value that the device can evaluate and the corresponding DN range.

Measurement	Instrument	Minimum value	Maximum value	DN range
Flowrate	Flow sensor	1,5 (l/h)	18*10 ⁶ (l/h) (*)	10 – 900 (mm)
	Variable area flowmeter	1.5 (l/h)	50000 (l/h)	10 – 65 (mm)
pH	pH sensor	0	14	all
Redox potential	ORP sensor	-2000 (mV)	+2000 (mV)	all
Conductivity	Conductivity sensor	0.055 (μS/cm)	1 (S/cm) (**)	all
Pressure and Level	Level and pressure transmitter	0 (bar)	25 (bar) (***)	all

(*) Special solutions for higher flow rates.

(**) Special solutions for higher values, until 2 S/cm.

(***) Special solutions for higher values, until 100 bar.

In addition, the table below describes the main wetted materials for every instrumentation family.

Main wetted materials	Instruments							
	Variable Area Flowmeter	Paddlewheel Sensor	Magmeter Sensor	ULF	Oval gear	pH/ORP Sensor	Conductivity Sensor	Level and pressure transmitter
UPVC	•							
CPVC	•	•				•	•	
ABS		•						
PP					•			
PVDF	•	•	•					•
PEEK			•					
Epoxy resin						•	•	
POM				•				
Trogamid	•							
Polysulfone	•							
Ryton						•		
Glass						•		
Graphite							•	
Platinum						•	•	
316 SS		•	•		•		•	
304 SS			•					
ECTFE		•		•	•			
EPDM		•	•					•
FPM		•	•	•	•			•
FFKM				•				

The information in this leaflet is provided in good faith. No liability will be accepted concerning technical data that is not directly covered by recognised international standards. Aliaxis reserves the right to carry out any modification. Products must be installed and maintained by qualified personnel.

Aliaxis Group sa/nv
Avenue Arnaud Fraiteur 15-23 1050 Brussels Belgium
T +32 2 775 50 50 • F +32 2 775 50 51
info@aliaxis.com www.aliaxis.com

