

 Aliaxis



VM DN 80÷100

PP-H

Diaphragm valve

# VM DN 80÷100

The VM is particularly suitable for shutting off and regulating abrasive or dirty fluids. The handwheel control and diaphragm seal provide precise and effective control, while reducing the risk of water hammer to a minimum.

## DIAPHRAGM VALVE

- Connection system for solvent welding and for flanged joints
- **Optimised fluid dynamic design:** maximum output flow rate thanks to the optimised efficiency of the fluid dynamics that characterise the new internal geometry of the body.
- Handwheel that stays at the same height during rotation, with internal bearing to minimise friction and operating torque
- Standard optical indicator
- **Internal operating components in metal** totally isolated from the conveyed fluid
- Bonnet fastening screws in STAINLESS steel protected against the external environment by PE plugs
- **New flanged bodies:** the new bodies, characterised by a monolithic flanged structure, are available in PVC-U, PVC-C, PP-H and PVDF. This design, free from body and flange joints, greatly reduces mechanical stress and increases system performance.

Technical specifications	
<b>Construction</b>	Single wear diaphragm valve
<b>Size range</b>	DN 80 ÷ 100
<b>Nominal pressure</b>	PN 10 with water at 20° C PN 6 with water at 20° C (PTFE version)
<b>Temperature range</b>	0 °C ÷ 100 °C
<b>Coupling standards</b>	<b>Welding:</b> EN ISO 15494. Can be coupled to pipes according to EN ISO 15494. <b>Flanging system:</b> ISO 7005-1, EN 1092-1, EN ISO 15494, EN 558-1, DIN 2501, ANSI B.16.5 cl. 150.
<b>Reference standards</b>	<b>Construction criteria:</b> EN ISO 16138, EN ISO 15494 <b>Test methods and requirements:</b> ISO 9393 <b>Installation criteria:</b> DVS 2202-1, DVS 2207-11, DVS 2208-1, UNI 11318.
<b>Valve material</b>	<b>Body:</b> PP-H <b>Bonnet:</b> PP-GR <b>Handwheel</b> PA-GR
<b>Seal material</b>	EPDM, FKM, PTFE (on request NBR)
<b>Control options</b>	Manual control; pneumatic actuator



**1 Handwheel** in (PA-GR) with high mechanical strength and ergonomic **grip for optimum manageability**

**2 Metal optical position indicator** supplied as standard

**3 Full protection bonnet in PP-GR** Internal circular and symmetrical diaphragm sealing area

**4 Diaphragm** available in EPDM, FKM, PTFE (NBR on request) and easy to replace

**5 Threaded metal inserts** for anchoring the valve

**6 New valve body internal design:** substantially higher flow coefficient resulting in lower pressure drops. Optimised adjustment curve for effective and precise flow rate regulation

# TECHNICAL DATA

## PRESSURE VARIATION ACCORDING TO TEMPERATURE

For water and non-hazardous fluids with regard to which the material is classified as CHEMICALLY RESISTANT. In other cases, a reduction of the nominal pressure PN is required (25 years with safety factor).

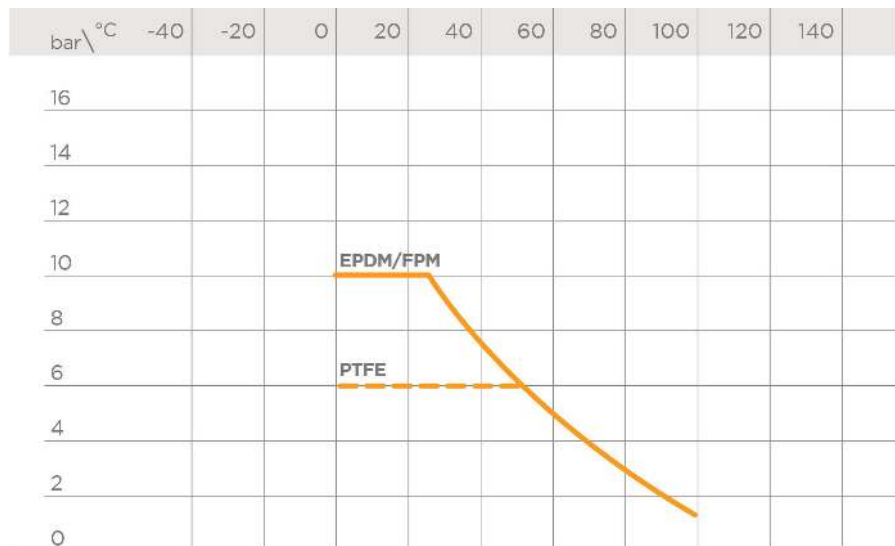

## PRESSURE DROP GRAPH

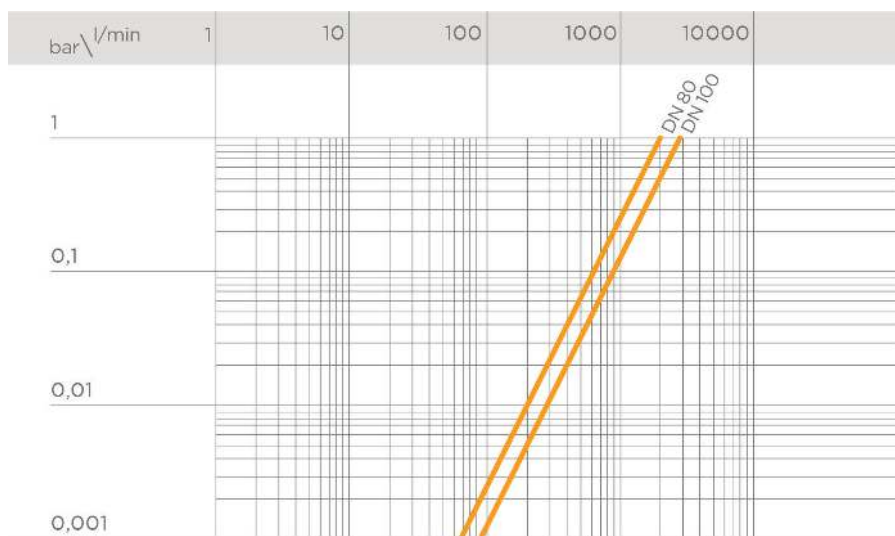

## K<sub>v</sub>100 FLOW COEFFICIENT

The K<sub>v</sub>100 flow coefficient is the Q flow rate of litres per minute of water at a temperature of 20°C that will generate Δp= 1 bar pressure drop at a certain valve position. The Kv100 values shown in the table are calculated with the valve completely open.

DN	80	100
Kv100 l/min	2910	4620

The information in this leaflet is provided in good faith. No liability will be accepted concerning technical data that is not directly covered by recognised international standards. FIP reserves the right to carry out any modification. Products must be installed and maintained by qualified personnel.

# DIMENSIONS

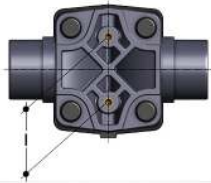
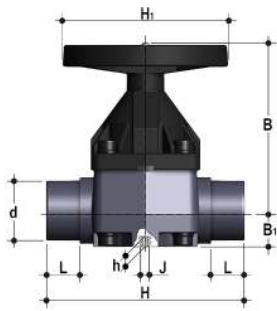

## VMDM

Diaphragm valve with male ends for socket welding, metric series

d	DN	PN	B	B <sub>1</sub>	H	H <sub>1</sub>	h	l	J	L	g	EPDM code	FKM code	PTFE code
90	80	*10	225	55	300	200	23	100	M12	51	6040	VMDM090E	VMDM090F	VMDM090P
110	100	*10	295	69	340	250	23	120	M12	61	9160	VMDM110E	VMDM110F	VMDM110P

\*PTFE PN6

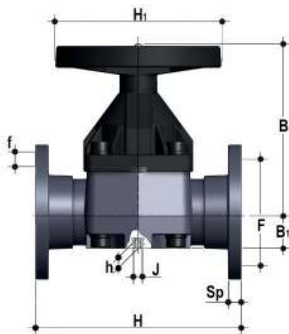

## VMOM

Diaphragm valve with flanged monolithic body, drilled EN/ISO/DIN PN10/16. Face to face according to EN 558-1

d	DN	PN	B	B <sub>1</sub>	F	f	H	H <sub>1</sub>	l	J	Sp	U	g	EPDM code	FKM code	PTFE code
90	80	*10	225	64	160	18	310	200	100	M12	22	8	7500	VMOM090E	VMOM090F	VMOM090P
110	100	*10	295	72	180	18	350	250	120	M12	23	8	10480	VMOM110E	VMOM110F	VMOM110P

\*PTFE PN6

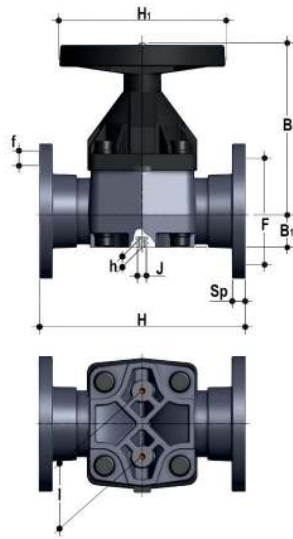

## VMOAM

Diaphragm valve with flanged monolithic body, drilled ANSI B16.5 cl.150 #FF

d	DN	PN	B	B <sub>1</sub>	F	f	H	H <sub>1</sub>	I	J	Sp	U	g	EPDM code	FKM code	PTFE code
3"	80	*10	225	64	152,4	19	263	200	100	M12	22	4	7500	VMOAM300E	VMOAM300F	VMOAM300P
4"	100	*10	295	72	190,5	19	328	250	120	M12	23	8	10480	VMOAM400E	VMOAM400F	VMOAM400P

\*PTFE PN6

For installation prior to october 2017 please contact Fip Technical Support

# COMPONENTS

## EXPLODED VIEW

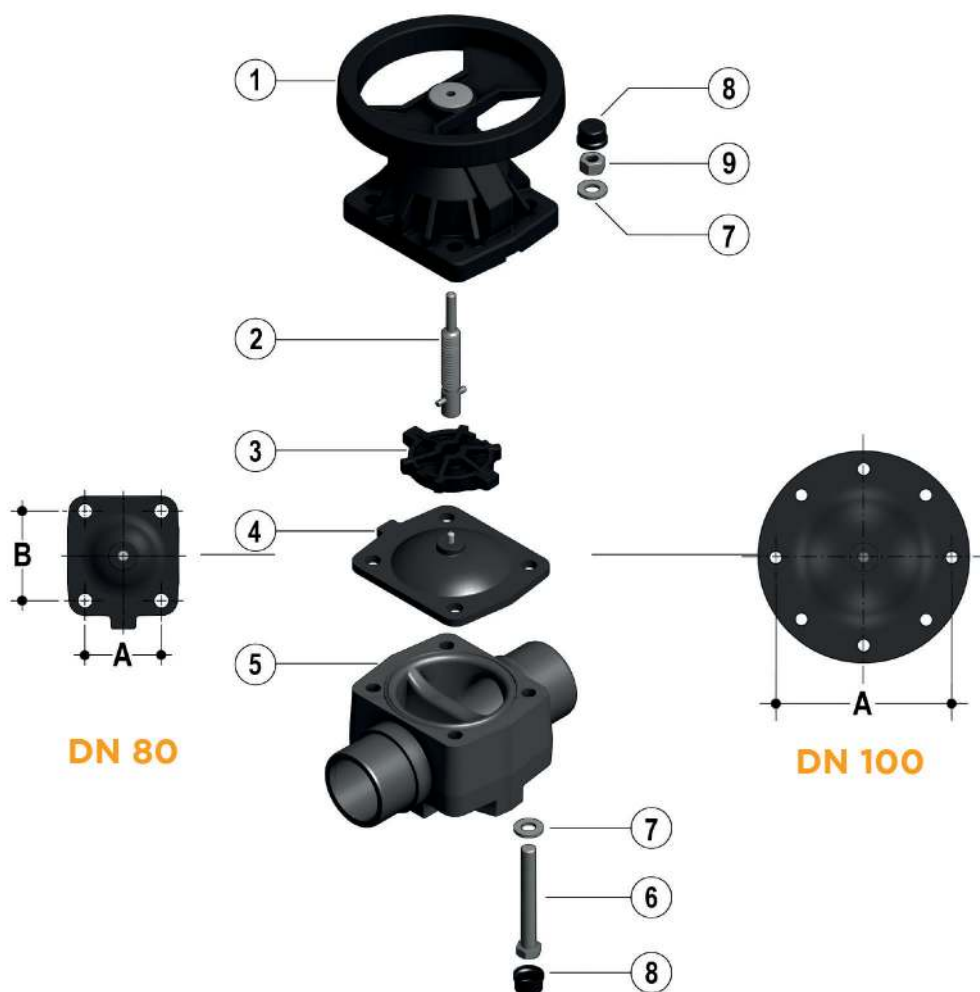

DN	80	100
A	114	193
B	127	-

- |   |   |   |
|---|---|---|
| <b>1</b> Bonnet (PP-GR - 1);<br>Handwheel (PA-GR - 1) | <b>4</b> Diaphragm seal (EPDM, FKM,<br>PTFE - 1)    | <b>7</b> Washer (Zinc plated steel - 4) |
| <b>2</b> Indicator - stem (STAINLESS<br>steel - 1)    | <b>5</b> Body (PP-H - 1)                            | <b>8</b> Protection plug (PE - 4)       |
| <b>3</b> Shutter (PBT - 1)                            | <b>6</b> Hexagonal screw (Zinc plated<br>steel - 4) | <b>9</b> Nut (Zinc plated steel - 4)    |

The material of the component and the quantity supplied are indicated in brackets

## DISASSEMBLY

The diaphragm constitutes the part of the valve more subject to mechanical and chemical stress from the fluid. Consequently, the condition of the diaphragm must be checked at regular intervals in accordance with the service conditions. To do this, it must be disconnected from the handwheel and from the valve body.

- 1) Cut-off fluid upstream from the valve and make sure it is de-pressurised (downstream drain if necessary).
- 2) Unscrew the four screws (6) and separate the body (5) from the internal components.
- 3) Unscrew the diaphragm (4) from the shutter (3). Rotate the handwheel clockwise to free the stem-shutter unit. Clean or replace the diaphragm, if necessary (4). If necessary, lubricate the stem (2).

## ASSEMBLY

- 1) Apply the shutter (3) to the stem (2), ensuring the stem pin is positioned correctly.
- 2) Screw the diaphragm (4) onto the stem (2), taking care not to stretch it.
- 3) Open the valve.
- 4) Place the bonnet-handwheel unit (1) on the body (5) and join the two components with bolts.
- 5) Press the protection plugs into place (8).



# INSTALLATION

The valve can be installed in any position and in any direction.

When starting up the plant, make sure that there are no leaks from between the diaphragm and the valve body. If necessary, tighten the fastening screws (6).

## **WARNINGS**

**Note:** during assembly operations, it is advisable to lubricate the threaded stem. Mineral oils are not recommended for this task as they react aggressively with EPDM rubber.

Moreover, as the diaphragm seal is compressed between the body and the actuator, the valve body stud-bolts and nuts must be checked and tightened, if necessary, prior to installation.